



# PowerBook G4 12-inch Getting Started

Includes setup, expansion, and  
troubleshooting information for  
your PowerBook G4 computer

🍏 Apple Computer, Inc.  
© 2004 Apple Computer, Inc. All rights reserved.

Under the copyright laws, this manual may not be copied, in whole or in part, without the written consent of Apple.

The Apple logo is a trademark of Apple Computer, Inc., registered in the U.S. and other countries. Use of the “keyboard” Apple logo (Option-Shift-K) for commercial purposes without the prior written consent of Apple may constitute trademark infringement and unfair competition in violation of federal and state laws.

Every effort has been made to ensure that the information in this manual is accurate. Apple is not responsible for printing or clerical errors.

Apple  
1 Infinite Loop  
Cupertino, CA 95014-2084  
408-996-1010  
www.apple.com

Apple, the Apple logo, AirPort, Apple Store, AppleTalk, Final Cut Pro, FireWire, iCal, iMovie, iTunes, Mac, Macintosh, the Mac logo, Mac OS, PowerBook, QuickTime, and Sherlock are trademarks of Apple Computer, Inc., registered in the U.S. and other countries.

Finder, the FireWire logo, iDVD, iLife, iPhoto, iPod, Rendezvous, Safari, and SuperDrive are trademarks of Apple Computer, Inc.

AppleCare is a service mark of Apple Computer, Inc., registered in the U.S. and other countries.

.Mac is a service mark of Apple Computer, Inc.

The Bluetooth® word mark and logos are owned by the Bluetooth SIG, Inc. and any use of such marks by Apple Computer, Inc. is under license.

ENERGY STAR® is a U.S. registered trademark.

PowerPC is a trademark of International Business Machines Corporation, used under license therefrom.

Other company and product names mentioned herein are trademarks of their respective companies. Mention of third-party products is for informational purposes only and constitutes neither an endorsement nor a recommendation. Apple assumes no responsibility with regard to the performance or use of these products.

The product described in this manual incorporates copyright protection technology that is protected by method claims of certain U.S. patents and other intellectual property rights owned by Macrovision Corporation and other rights owners. Use of this copyright protection technology must be authorized by Macrovision Corporation and is intended for home and other limited viewing uses only unless otherwise authorized by Macrovision Corporation. Reverse engineering or disassembly is prohibited.

Apparatus Claims of U.S. Patent Nos. 4,631,603, 4,577,216, 4,819,098 and 4,907,093 licensed for limited viewing uses only.

Simultaneously published in the United States and Canada.

# Contents

<b>Chapter 1</b>	<b>5 Getting Started</b>
	6 Basic Features of Your PowerBook
	8 Additional Features of Your PowerBook
	10 Setting Up
	16 How Do I Turn My PowerBook Off?
	17 Calibrating Your Battery
	18 What's Next?
<b>Chapter 2</b>	<b>19 The Basics</b>
	19 Getting to Know Your New PowerBook
	20 Adjusting Your Display
	21 Using Your Power Adapter
	22 Using the Trackpad
	23 Using the Keyboard
	23 Using a Mouse
	24 Learning About Mac OS X
	24 Customizing Your Desktop and Setting Your Preferences
	25 Connecting to a Printer
	26 Playing a CD and Connecting Headphones
	27 Keeping Your Software Up to Date
	27 Connecting a Camera or Other FireWire or USB Device
	28 Connecting to a Network
	28 Using the Internet
	28 Transferring Files to Another Computer
	29 When an Application Freezes
<b>Chapter 3</b>	<b>31 Using Your Computer</b>
	32 Universal Serial Bus (USB)
	34 FireWire
	36 Using Bluetooth Devices
	37 AirPort Extreme Wireless Networking and Internet Access
	38 Ethernet (10/100Base-T)
	39 Using Your Modem

	39	Connecting Speakers and Audio Devices
	40	External Video Support (DVI, VGA, Composite, and S-Video)
	43	Using Your Optical Drive
	46	Battery
	49	Security Slot
<b>Chapter 4</b>	<b>51</b>	<b>Adding Memory to Your Computer</b>
	51	Installing Additional Memory
<b>Chapter 5</b>	<b>57</b>	<b>Troubleshooting</b>
	58	Problems That Prevent You From Using Your Computer
	59	Other Problems
	61	Restoring Your Computer's Software
	62	Locating Your Product Serial Number
<b>Appendix A</b>	<b>63</b>	<b>Specifications</b>
<b>Appendix B</b>	<b>65</b>	<b>Care, Use, and Safety Information</b>
	65	Cleaning Your PowerBook
	65	Carrying Your PowerBook
	65	Storing Your PowerBook
	66	Safety Instructions for Setting Up and Using Your Computer
	67	General Safety Instructions
	68	Battery
	68	Connectors and Ports
	68	Avoid Hearing Damage
	68	Apple and the Environment
	69	Ergonomics
<b>Appendix C</b>	<b>71</b>	<b>Connecting to the Internet</b>
	73	Gathering the Information You Need
	74	Entering Your Information
	75	Dial-Up Modem With Point-to-Point Protocol (PPP) Connections
	77	DSL, Cable Modem, or LAN Internet Connections
	83	AirPort Extreme Wireless Connection
	86	Troubleshooting Your Connection
<b>Appendix D</b>	<b>89</b>	<b>Top Ten Questions</b>
	93	Communications Regulation Information
<b>Index</b>	<b>99</b>	

Your PowerBook is a full-featured notebook computer.

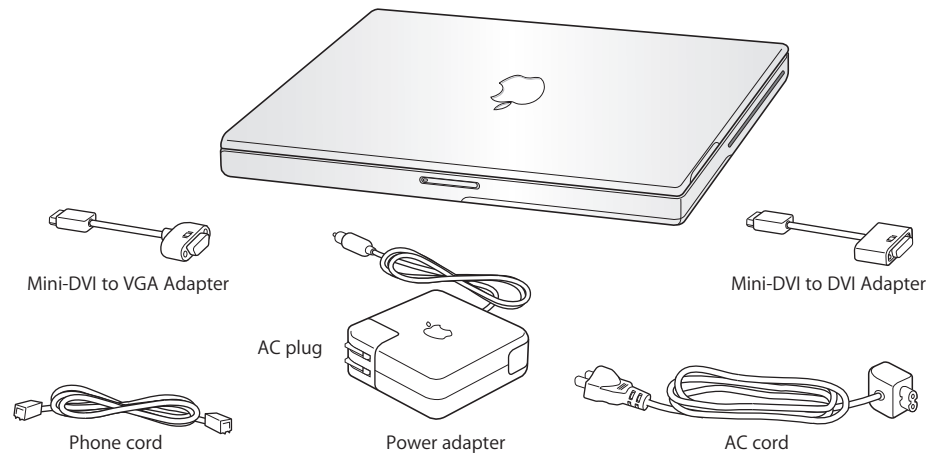

**Important:** Read all the installation instructions and safety information (see page 65) carefully before you plug your computer into a wall socket.

# Basic Features of Your PowerBook

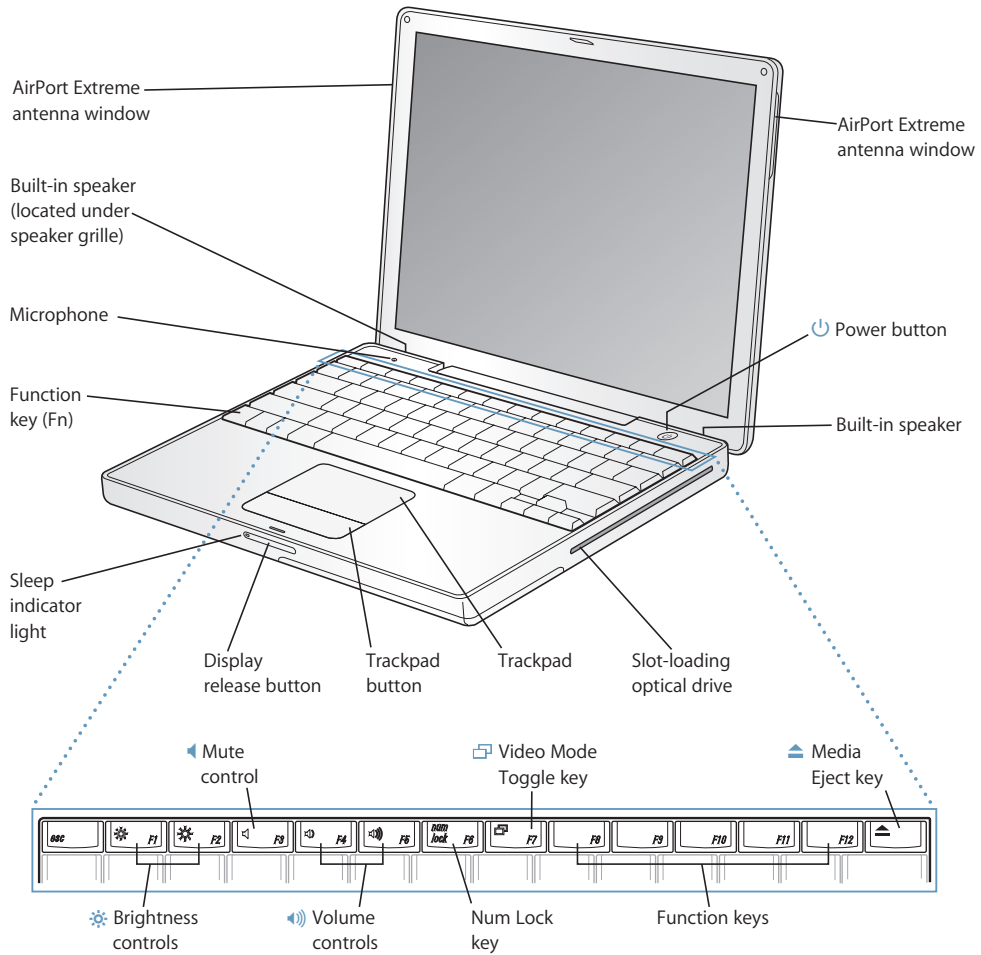

**Brightness controls**

Increase or decrease the brightness of your PowerBook display.

**Volume controls**

Increase or decrease the volume of the sound coming from the built-in speakers and headphone port.

**Num Lock key**

Activate the numeric keypad embedded in the PowerBook keyboard. When the numeric keypad is activated, a green light glows on the key.

**Video Mode Toggle key**

Use this key to switch between dual-display mode and video-mirroring mode.

**Media Eject key**

Press and hold this key to eject a disc. You can also eject a disc by dragging its desktop icon to the Trash.

**Microphone**

Record sounds directly on your PowerBook hard disk with this built-in microphone.

**Built-in stereo speakers**

Listen to music, movies, games, and multimedia.

**Function (Fn) key**

Press and hold this key to activate the function keys (F1 to F12).

**Sleep indicator light**

A white light pulsates when the PowerBook is in sleep.

**Display release button**

Push this button to release your display and open your PowerBook.

**Trackpad**

Move the pointer on the PowerBook display.

**Slot-loading optical drive**

Your optical drive can read CD-ROM discs, Photo CDs, standard audio discs, DVD-ROM and DVD-R discs, DVD movies, and other kinds of media. It can also write music, documents, and other digital files on CD-R and CD-RW discs. If you have a SuperDrive, you can also write to DVD-R discs.

**Power button**

Turn your PowerBook on and off or put it to sleep.

**AirPort Extreme antenna windows**

With an AirPort Extreme Base Station or other wireless hub, connect to the Internet wirelessly.







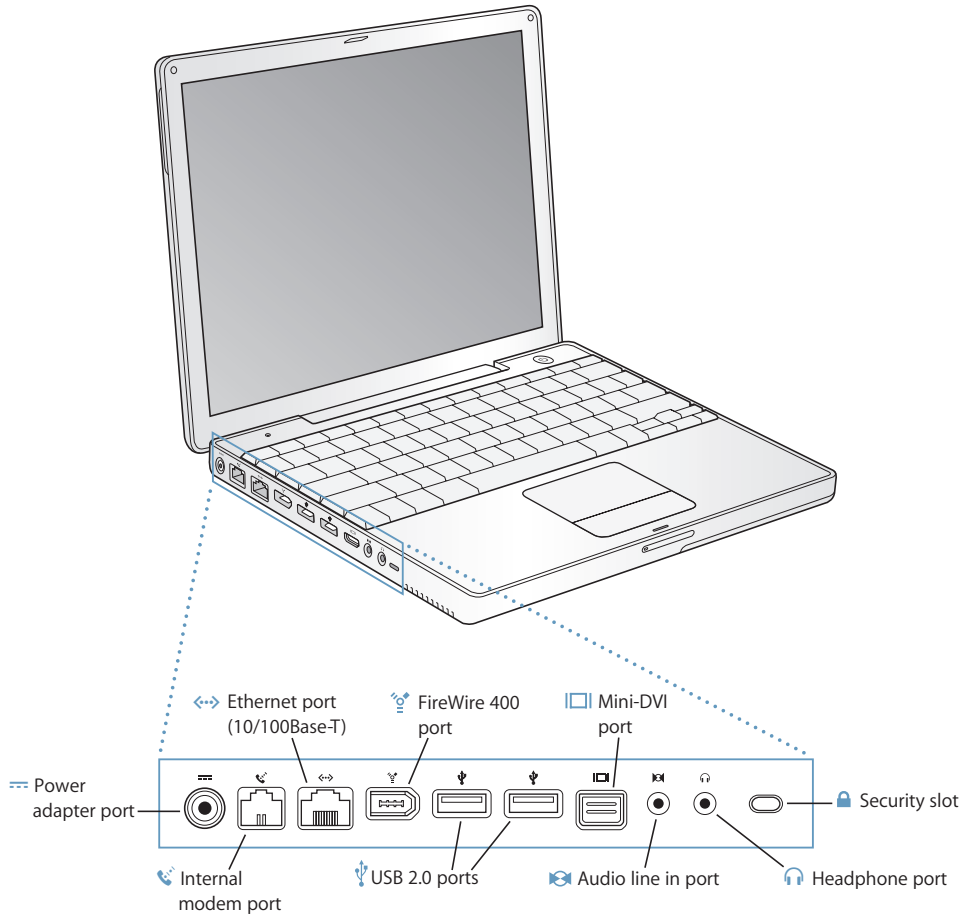

---

For additional information about AirPort Extreme or your optical drive, see Chapter 3, "Using Your Computer," on page 31.

## Additional Features of Your MacBook





- 
-  **Power adapter port**  
Plug in the included Apple Portable Power Adapter to recharge your PowerBook battery.
  -  **Internal modem port**  
Connect a standard phone line directly to the internal modem.
  -  **Ethernet port (10/100Base-T)**  
Connect to a high-speed 10/100Base-T Ethernet network or connect to another computer and transfer files. The Ethernet port auto-sensing feature detects other Ethernet devices. You don't need an Ethernet crossover cable to connect to other Ethernet devices.
  -  **FireWire port (400)**  
Connect high-speed external devices, such as digital videocameras, and external storage devices. For more information, see page 34.
  -  **Two USB 2.0 (Universal Serial Bus) ports**  
Connect additional equipment to your PowerBook, such as printers, external storage devices, digital cameras, modems, keyboards, and joysticks.
  -  **Mini-DVI (external monitor) port**  
Using the included Mini-DVI to DVI Adapter, connect your PowerBook to an Apple flat-panel display or other display that has a DVI connector. Connect to an external monitor or projection device that uses a VGA connector with the included Mini-DVI to VGA Adapter. You can also use a Mini-DVI to Video Adapter (sold separately) for composite and S-video support to connect to a television, VCR, or another video device.
  -  **Audio line in port**  
Connect your PowerBook to a line-level microphone or other audio equipment.
  -  **Headphone (audio line out) port**  
Connect external speakers, headphones, or other sound output devices.
  - Security slot**  
Protect your PowerBook by connecting a security cable.
- 

For additional information about these features, see Chapter 3, "Using Your Computer," on page 31.

## Setting Up

Your MacBook is designed so that you can set it up quickly and start using it right away.

### Step 1: Plug In the Power Adapter

- Plug the AC plug of your power adapter into an outlet and the power adapter plug into the MacBook power adapter port.

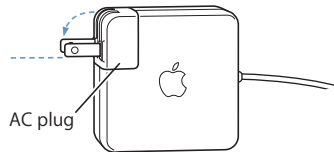

**Important:** Be sure to snap the electrical prongs on your AC plug into their completely extended position before you plug the adapter into the outlet.

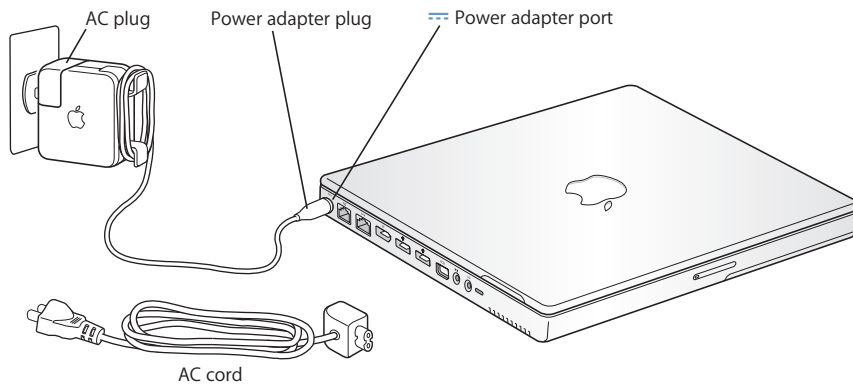

To extend the reach of your power adapter, you can attach the AC cord if desired. See "Using Your Power Adapter" on page 21.

## Step 2: Prepare to Get Connected

The first time you start up your computer, a setup assistant welcomes you and takes you through the registration process. It will also help you set up your computer and Internet connection. Internet access usually requires an account with an Internet service provider (ISP). Fees may apply.

Setting up your Internet connection usually requires you to supply information such as the account name your ISP gives you. If you're not ready to set up your connection yet, you can skip that process and come back to it later. See Appendix C, "Connecting to the Internet," on page 71 for information about how to set it up later. If you are ready, gather the information below for the type of connection you'll be using.

You can write information from your ISP or network administrator on these pages, then enter it in Setup Assistant.

### To set up a telephone dial-up connection, gather the following information:

- Service provider name
- User or account name
- Password
- ISP phone number
- Alternate phone number
- Dialing prefix to obtain an outside line

### To set up a DSL, cable modem, LAN, or AirPort Extreme wireless connection:

- First, choose your connection method (ask your system administrator or your ISP, if you don't know):
  - Manually
  - Using DHCP with a manual address
  - Using DHCP
  - Using BootP
  - PPP

If you're unsure which method to use, "Using DHCP" may be a good choice, because the network supplies most of the required information for you automatically.

If you selected "Manually" or "Using DHCP with a manual address," gather the following:

- IP address
- Subnet mask
- Router address

**Note:** If you selected "Using DHCP with a manual address," you don't need a subnet mask or router address.

If you selected “Using DHCP,” gather the following optional information (ask your ISP if you need it):

- DHCP client ID
- DNS servers

If you selected “PPP” (for PPPoE connections), gather the following:

- Service provider
- Account name
- Password
- PPPoE service name

The information below is optional. Ask your ISP or system administrator if you need it.

- DNS servers
- Domain name
- Proxy server

### Step 3: **Connect Your Cables**

Next, connect your PowerBook to a phone line, DSL modem, cable modem, or Ethernet network. If you’re connecting to a wireless AirPort Extreme network, you don’t need cables.

#### **To connect to a phone line:**

- Connect the phone cord from a wall jack to the internal modem port for a dial-up connection.

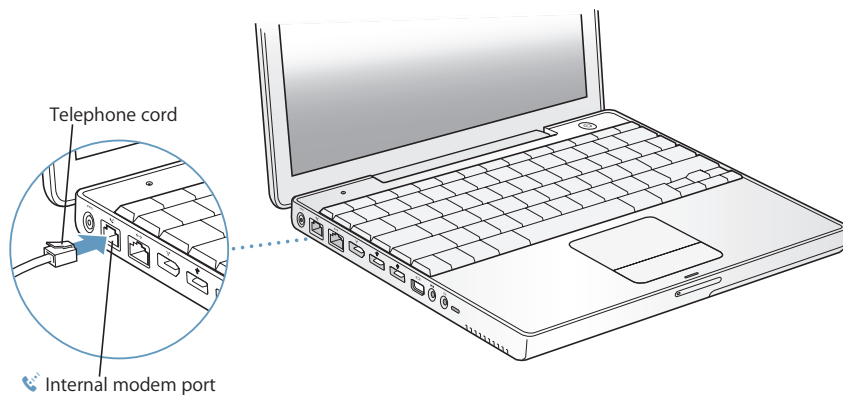

Make sure you connect the internal modem to an analog phone line—the kind used typically in homes. The modem will not work with a digital phone line.

**Warning:** Do not connect a digital telephone line to the modem; the wrong type of line could damage the modem. Contact your telephone service provider if you are unsure whether you have a digital telephone line.

For more information about your modem, see “Using Your Modem” on page 39. For information on other types of connections, see Appendix C, “Connecting to the Internet,” on page 71.

**To connect to a DSL or cable modem or an Ethernet network:**

- Connect the cable to your DSL or cable modem as shown in the modem instructions, or connect the Ethernet cord to the Ethernet hub or outlet. Then connect the other end of the cord to the computer’s Ethernet port.

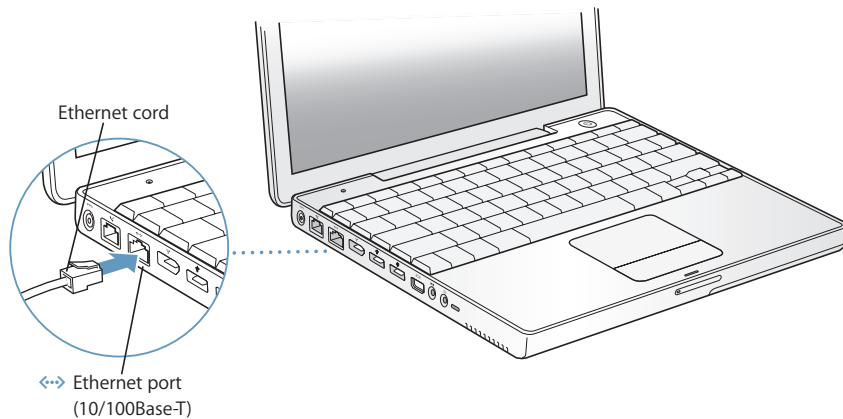

#### Step 4: Turn On Your PowerBook

With your setup information gathered, you're ready to start up your computer. Once you do, Setup Assistant opens automatically to help you.

- 1 To turn on the computer, press the Power button (⏻).

**Note:** When you press the Power button to start up your computer, press it only once briefly (up to 1 second). Do not continue to hold down or press the Power button after the startup tone or you may cause the computer to shut down again.

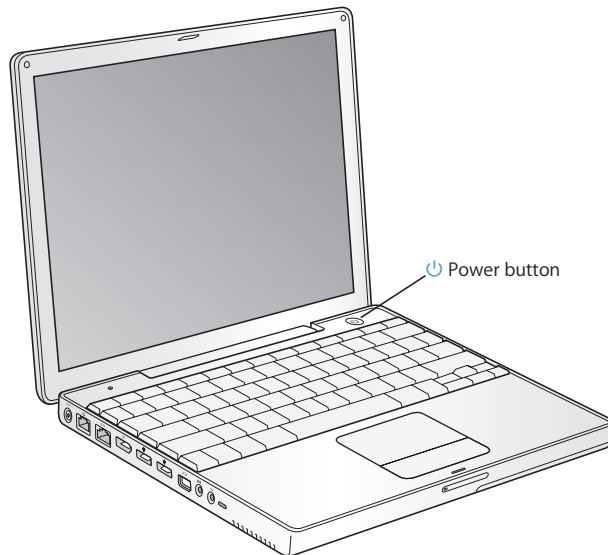

You should hear a startup tone when you turn on the computer. It takes the computer a few moments to start up.

#### Problems Turning the Computer On?

##### Nothing happens when you press the Power button.

- The battery may be drained. Make sure that you plugged the power adapter firmly into both the computer and a power source. The plug should light when you plug it into the computer.
- If the computer still doesn't start up, see "Problems That Prevent You From Using Your Computer" on page 58.

##### You see a picture of a disk or a folder with a blinking question mark.

- This icon usually means that the computer can't find system software on the hard disk or any disks attached to the computer. Try restarting. Hold down the Power button for 4 to 5 seconds until the computer turns off. Then press the Power button again. If the problem persists, you may need to reinstall system software. See "Restoring Your Computer's Software" on page 61.

- 2 Use your PowerBook trackpad to select and move items on the screen, much as you use a mouse with a desktop computer.
  - To move the arrow pointer on the screen, slide your finger across the trackpad.
  - To select, click, or double-click an item on the screen, use the trackpad button.

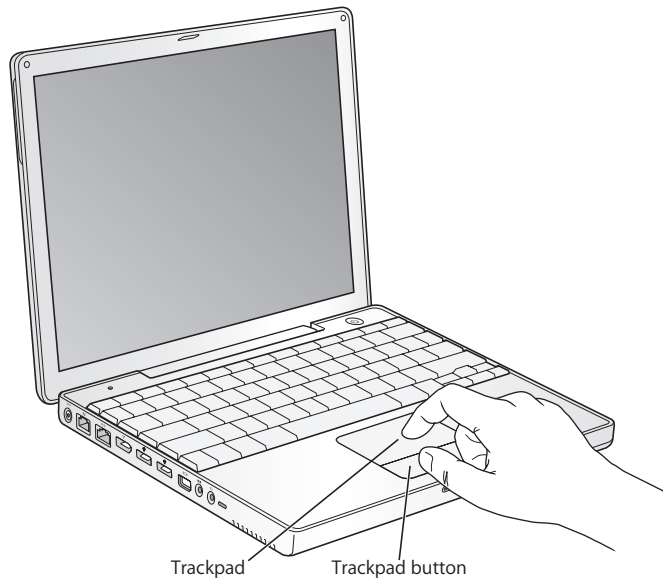

For tips on using the trackpad, see “Tips for Using the Trackpad” on page 22.

Congratulations, you’re up and running!

## How Do I Turn My PowerBook Off?

When you have finished working with your PowerBook, you can put your computer to sleep or shut it down.

### Putting Your PowerBook to Sleep

If you will be away from your PowerBook for only a short time, put the computer to sleep. When the computer is in sleep, you can quickly wake it and bypass the startup process.

**To put the computer to sleep, do one of the following:**

- Close the display.
- Choose Apple () > Sleep from the menu bar.
- Press the Power button (⏻) and click Sleep in the dialog that appears.



**Warning:** Wait a few seconds until the white sleep light on the display latch starts pulsating (indicating that the computer is in sleep and the hard disk has stopped spinning) before you move your PowerBook. Moving your computer while the hard disk is spinning can damage the hard disk, causing loss of data or the inability to start up from the hard disk.

**To wake the computer:**

- *If the display is closed*, open it. Your PowerBook automatically wakes from sleep when you open the display.
- *If the display is already open*, press the Power button (⏻) or any key on the keyboard.



## Shutting Down Your PowerBook

If you aren't going to use your PowerBook for a day or two, shut it down.

**To shut down your computer, do one of the following:**

- Choose Apple () > Shut Down from the menu bar.
- Press the Power button (⏻) and click Shut Down in the dialog that appears.



If you plan to store your PowerBook for an extended period of time, see “Storing Your PowerBook” on page 65 for information on how to prevent your battery from draining completely.

## Calibrating Your Battery

To get the longest running time from your PowerBook battery, complete the following steps sometime during the first week you have your PowerBook.

**To initially calibrate your battery, follow these steps:**

- 1 Plug in the power adapter and fully charge your PowerBook battery until the light on the power adapter plug changes to green and the onscreen meter in the menu bar indicates that the battery is fully charged.
- 2 Disconnect the power adapter and use your PowerBook.

When your battery gets low, you will see the first low-battery warning dialog on the screen. Continue to use your PowerBook until it automatically goes to sleep; at that point the battery has been sufficiently drained for calibration.

- 3 Connect the power adapter and leave it connected until the battery is fully charged again.

**Important:** You only have to fully discharge and then charge your battery once to calibrate it. After that, you can connect and disconnect the power adapter when the battery is at any charge level.

If you purchased additional batteries, repeat the calibration procedure with the additional batteries as well. For more information about your power adapter and battery, see “Using Your Power Adapter” on page 21 and “Battery” on page 46.

## What's Next?

- Learn the important basics about your PowerBook. Check out Chapter 2, “The Basics,” on page 19.
- Have fun trying out your computer’s applications and Internet features. Browse the Mac OS X booklet that came with your computer.
- If you’re unfamiliar with Mac OS X, open Mac OS Help and browse the information.
- Switching from another computer? Choose Help > Mac Help from the menu bar and see the “New to Mac OS X” section. It will help you use your previous computer knowledge to get started on a Mac.

## What If I Have More Questions?

### Mac OS Help

Most of the information about using your Macintosh is available right on your computer.

- 1 Click the Finder icon in the Dock (the bar of icons at the bottom of the screen).



- 2 Choose Help > Mac Help (click the Help menu in the menu bar and choose Mac Help).



- 3 Click the Search field, type a question, and press Return on your keyboard.

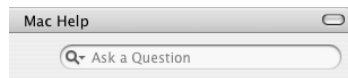

## Other Support

- If you’re having a problem that prevents you from using your computer, see Chapter 5, “Troubleshooting,” on page 57.
- Check out the top ten most commonly asked questions. See Appendix D, “Top Ten Questions,” on page 89.
- For support information, user discussion boards, and the latest Apple software downloads, go to [www.apple.com/support](http://www.apple.com/support).
- If you can’t find the answer to your problem in these places, see the AppleCare materials that came with your computer for information on contacting Apple.

This chapter introduces important basics about your PowerBook that you'll want to know.

## Getting to Know Your New PowerBook

Because your PowerBook is so thin and light, you can take it with you to the office, library, class, or wherever you work or play.

Whenever you stop using your PowerBook, wait a few moments to let the hard disk and any optical disc in your drive stop spinning before you transport the computer. Avoid jostling or bumping your PowerBook while discs are spinning.

When using your PowerBook or when charging the battery, it is normal for the bottom of the case to get warm. For prolonged use, place your PowerBook on a flat, stable surface. The bottom of the case is raised slightly to allow airflow that keeps the unit within normal operating temperatures.

As you get to know your new computer, you may hear small noises during startup and when using your hard disk and optical drives. For example, your hard disk and optical drives may whirl and click as they access information or load and eject discs. After the PowerBook runs for some time, a small fan may turn on to cool it, producing a faint sound. Small noises are part of the PowerBook's normal functioning.

For more safety instructions about handling and using your PowerBook in different locations, be sure to see Appendix B, "Care, Use, and Safety Information," on page 65.

## Adjusting Your Display

Once you begin working with your new PowerBook, you may need to adjust your display so that the screen is easier to see. Use the keys labeled with the  icon to adjust screen brightness.

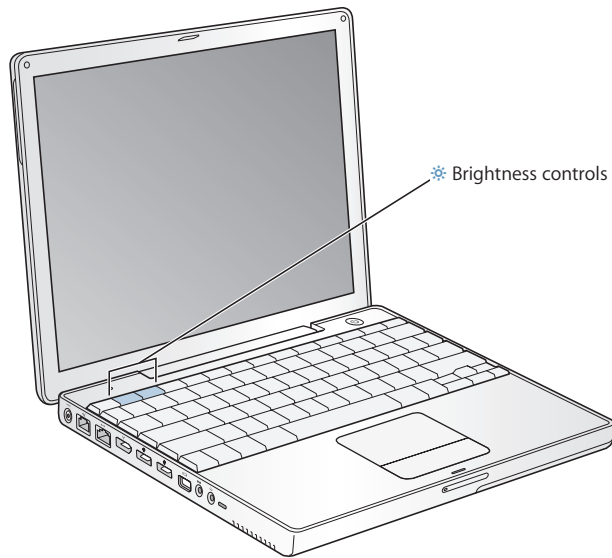

You can increase or decrease the size of images on your display by switching from the standard resolution to a scaled resolution. Your PowerBook has a 12.1-inch TFT XGA display with a default resolution of 1024 x 768.

You can choose a resolution of 800 x 600 or lower (called “scaled” resolutions) in the Displays pane of System Preferences. When you switch to a scaled resolution, items on the screen appear larger, making them easier to see. However, scaled resolutions may not be as sharp as they are at the display’s default resolution.

### To adjust the resolution on your display:

- Choose Apple () > System Preferences from the menu bar. Open the Displays pane of System Preferences.

To control your display settings using the Displays icon in the menu bar, click “Show displays in menu bar.”

## Using Your Power Adapter

Plugging in the power adapter provides AC power to the computer and recharges the computer's battery.

**Important:** For optimal performance, use only the power adapter that came with your computer.

When you first connect your power adapter to your computer, the adapter light glows green for a second to indicate power is available. An amber light indicates that the battery is being charged. A green light indicates that the battery is fully charged. You can monitor the battery level using the Battery icon in the menu bar or by checking the battery level indicator lights on the bottom of the battery (see page 46).

To extend the reach of your power adapter, remove the AC plug from the adapter. Attach the included AC cord to the adapter and insert the other end into a wall outlet.

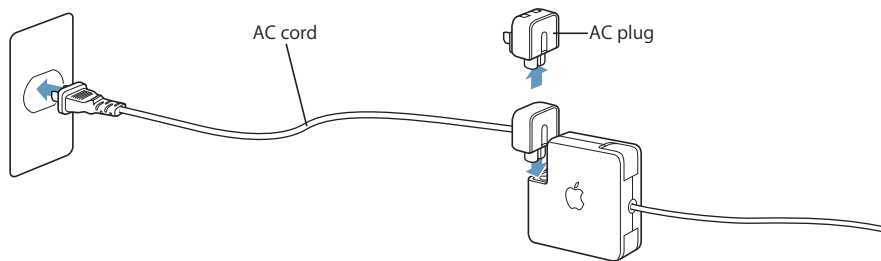

**Warning:** Make sure the power adapter is fully assembled before plugging it into an electrical outlet. If you're using the AC plug with your power adapter, make sure the two prongs are snapped into their completely extended position before plugging in the adapter.

Use only the AC cord that came with your power adapter. Make sure to push the power plug snugly into the power adapter port on the computer to ensure it is engaged and power is flowing to the computer.

When disconnecting the power adapter from an outlet or from the computer, pull the plug, not the cord.

For safety instructions about using your power adapter, see "Plugging In the Power Adapter" on page 66.

## Using the Trackpad

The trackpad is sensitive to how quickly you move your finger. To move the pointer a short distance across the screen, move your finger slowly across the trackpad. The faster you move your finger, the farther the pointer moves on the screen.

### Tips for Using the Trackpad

For best results when using the trackpad, keep in mind these tips:

- Use only one finger. Using more than one finger may cause erratic pointer behavior.
- Do not use a pen or any other object.
- Keep your finger and the trackpad dry. If the trackpad becomes moist from humidity or condensation, gently wipe it with a clean cloth before you use it.
- Never use any kind of cleaning solution on the trackpad.

For more information on using the trackpad, choose Help > Mac Help from the menu bar at the top of the screen.

Instead of using the trackpad button, you can use your finger to click and double-click directly on the trackpad. You turn on this and other trackpad options in the Keyboard & Mouse pane of System Preferences.

**Note:** If you find that the pointer moves as you type because you accidentally brush the trackpad, you can avoid this problem by selecting the “Ignore accidental trackpad input” option (in the Trackpad pane) in the Keyboard & Mouse pane of System Preferences.

## Using the Keyboard

Your PowerBook keyboard has a numeric keypad incorporated in the standard keyboard keys. Keys used for the numeric keypad have a smaller secondary label.

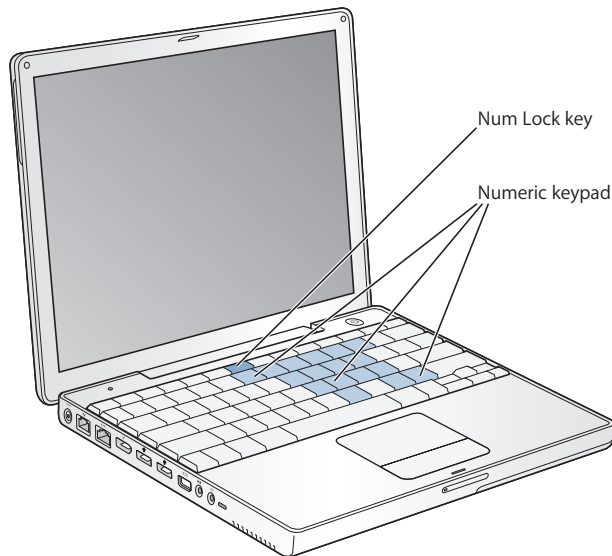

To use the numeric keypad, press the Num Lock key. The Num Lock key glows green, indicating that the keypad is active. When you're finished, press the Num Lock key again to turn it off.

**Important:** If your keyboard doesn't seem to be working correctly, check the Num Lock key. When the numeric keypad is active, other keys and keyboard equivalents for menu commands (such as ⌘-Q to quit) are deactivated.

If you like to use keyboard shortcuts to work efficiently, choose Help > Mac Help from the menu bar and search for "shortcuts." You'll find quite a list of keyboard shortcuts for many common procedures and applications.

## Using a Mouse

If you have an Apple mouse with a USB connection, you can insert the USB connector into the USB 2.0 port and use your mouse right away. You can purchase a USB mouse from an Apple Authorized Reseller or from the Apple Store website: [www.apple.com/store](http://www.apple.com/store). You can also use a wireless mouse that uses Bluetooth wireless technology. For more information about Bluetooth wireless technology, see "Using Bluetooth Devices" on page 36.

## Learning About Mac OS X

Your computer comes with Mac OS X and features Classic, an environment for using Mac OS 9 applications while the computer is running Mac OS X.

**Note:** Mac OS 9 cannot be installed as the primary operating system on your PowerBook.

When you're ready to learn more about Mac OS X and your Apple applications, see the Mac OS X booklet that came with your PowerBook. Also open Mac OS Help and browse the information there. You'll find plenty of information for new users, experienced users, and people switching to the Mac.

For information about the compatibility of software applications with Mac OS X, or to read more about Mac OS X, check the Apple website: [www.apple.com/macosx](http://www.apple.com/macosx).

## Customizing Your Desktop and Setting Your Preferences

You can quickly make your desktop look the way you want using System Preferences. Choose Apple () > System Preferences from the menu bar.





Feel free to make changes and experiment with the following:

- *Appearance*: Select this preference pane to change the colors of buttons, menus, windows, and highlight colors, among other options.
- *Desktop & Screen Saver*: Select this preference pane to change the background color or pattern of your desktop, or change it to a photo or image you like. You can also choose an eye-catching screen effect that will appear on your screen when the computer is left idle.
- *Dock*: Select this preference pane to change the look, location, and behavior of your Dock.

As you get to know your computer, explore the other System Preferences. It is your command center for most settings on your PowerBook. For more information, choose Help > Mac Help from the menu bar and search for “System Preferences” or for the specific preference pane you want to change.

**Note:** Because Apple frequently releases new versions and updates to its system software, applications, and Internet sites, images shown in this book may be slightly different from what you see on your screen.

## Connecting to a Printer

To use a printer with your PowerBook, follow the instructions that came with the printer to install required software and connect the printer. Many printers connect via a USB cable; others are accessed via a network connection, such as Ethernet. For more information about your USB ports, see “Universal Serial Bus (USB)” on page 32. For more information about a network or wireless connection, see “Ethernet (10/100Base-T)” on page 38 and “AirPort Extreme Wireless Networking and Internet Access” on page 37.

After connecting and setting up your printer, use the Print & Fax pane of System Preferences to select your printer for use. If you’re connecting to a printer via a network, you may need to know the network name or address of the printer to select it. If you have a USB printer connected to an AirPort Extreme Base Station, and you have an AirPort Extreme Card installed in your PowerBook, you can connect to the printer and print wirelessly.

### To set up a printer:

- 1 Open System Preferences and click the Print & Fax icon.
- 2 Click the Set Up Printers button.
- 3 Click the Add button.

- 4 Choose the type of connection for your printer (for example, USB, AppleTalk, and so on) from the pop-up menu.

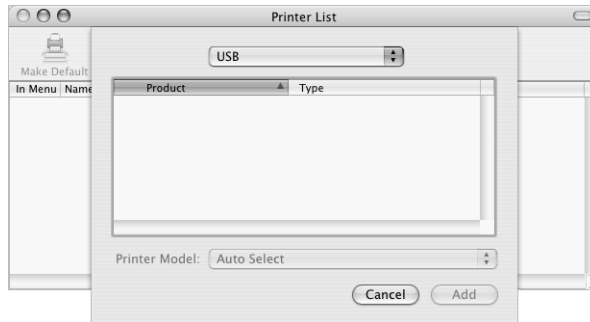

To add a USB printer connected to an AirPort Extreme Base Station, choose Rendezvous from the pop-up menu.

- 5 Select or enter your printer information and click Add.

### Monitoring Printing

Once you've sent a document to a printer, you can monitor printing and halt or put it temporarily on hold.

#### To monitor printing:

- Click the Printer icon in the Dock to open the Printer window.

You can now see the print jobs in the print queue and work with them. For more information, choose Help > Mac Help from the menu bar and search for "printing."

### Playing a CD and Connecting Headphones

If you'd like to listen to music while you work, insert a music CD in your optical drive. iTunes, an easy-to-use music player, appears automatically on the screen. You can also connect headphones with a minijack to the headphone port of your PowerBook for private listening. To learn more about iTunes, open iTunes and see the iTunes onscreen help. To learn more about your optical drive, see "Using Your Optical Drive" on page 43.

**Warning:** Listening to music at high volume over extended periods of time can damage your hearing.

## Keeping Your Software Up to Date

You can connect to the Internet and automatically download and install the latest free software versions, drivers, and other enhancements from Apple.

When you are connected to the Internet, Software Update checks Apple's Internet servers to see if any updates are available for your computer. You can set your Mac to check the Apple server periodically and download and install updated software.

### To check for updated software:

- 1 Open System Preferences.
- 2 Click the Software Update icon and follow the directions on the screen.



- For more information, search for “Software Update” in Mac OS Help.
- For the latest information on the Mac OS, go to the Mac OS website at [www.apple.com/macos](http://www.apple.com/macos).

## Connecting a Camera or Other FireWire or USB Device

If you have a digital camera, videocamera, scanner, or other device that has a FireWire or USB connector, you can connect it to your PowerBook. Follow the installation instructions that came with your device. For more information about FireWire, see “FireWire” on page 34. For more information about USB, see “Universal Serial Bus (USB)” on page 32.

## Connecting to a Network

If you want to connect your PowerBook to an Ethernet network or a wireless network, see “Ethernet (10/100Base-T)” on page 38 and “AirPort Extreme Wireless Networking and Internet Access” on page 37 for more information about setting up an Ethernet or AirPort connection. Also choose Help > Mac Help from the menu bar and search for “Ethernet” or open the AirPort Admin Utility and choose Help > AirPort Help.

## Using the Internet

During the initial setup, you were instructed on how to connect to the Internet. If you need to change to a different type of connection, such as DSL, cable modem, Ethernet local area network (LAN), or AirPort Extreme network, you can find more information in Appendix C, “Connecting to the Internet,” on page 71.

## Transferring Files to Another Computer

If you want to transfer files or documents to or from your PowerBook, there are several ways of doing it.

- If you have a USB or FireWire external hard disk or other drive, you can use it to transfer files from one computer to another.
- You can transfer files via the Internet using .Mac or another Internet account.
- You can transfer files to another computer on a network. You can access another server or computer by clicking Network in the Finder Sidebar, or by choosing Go > Connect to Server from the Finder menu bar.
- You can create a small Ethernet network by connecting an Ethernet cable from your PowerBook to another computer’s Ethernet port. For more information, choose Help > Mac Help from the menu bar and search for “connecting two computers.”
- You can also connect to another Mac using a FireWire cable. Your PowerBook appears as a disk drive on the other computer and you can transfer files. For information about using FireWire to transfer files, see “FireWire Target Disk Mode” on page 35.
- If your computer has an AirPort Extreme Card, you can connect to an AirPort Extreme wireless network to transfer files. For more information, see “AirPort Extreme Wireless Networking and Internet Access” on page 37.
- If you have access to devices that communicate via Bluetooth wireless technology, you can transfer files using Bluetooth wireless technology. For more information, see “Using Bluetooth Devices” on page 36.

For general information about transferring files and documents, see “Switching to the Mac,” located in the “Learn More About Your Mac” folder in the Documents folder on your hard disk. Also open Mac OS Help and search for the type of connection you need.

## When an Application Freezes

On rare occasions, an application may freeze on the screen. Mac OS X provides a way to quit a frozen application without restarting your computer. Quitting a frozen application may allow you to save your work in other open applications.

### To force an application to quit:

- 1 Press Command (⌘)-Option-Esc or choose Force Quit from the Apple () menu.

The Force Quit Applications dialog appears with the application selected.

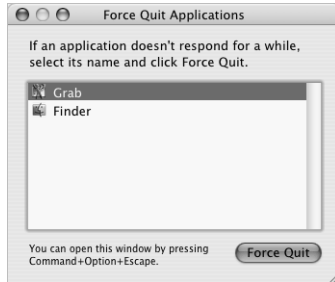

- 2 Click Force Quit.

The application quits, leaving all other applications open.

If needed, you can also force the Classic environment to quit, which closes all Classic applications. You can also restart the Finder from this dialog.

If you're experiencing other problems, see Chapter 5, "Troubleshooting," on page 57.



Your PowerBook has many built-in features and connection capabilities that you can customize and expand to fit your needs.

These include the following:

- Universal Serial Bus (USB) 2.0 ports for connecting additional equipment such as printers, scanners, and other devices to your PowerBook. See page 32.
- FireWire 400 port for connecting high-speed equipment such as digital videocameras and external hard drives. See page 34.
- Bluetooth wireless connectivity, AirPort Extreme wireless networking capability, Ethernet networking capability, and a 56K modem for networking and communications. See page 36.
- Audio line in and headphone (audio line out) ports for connecting headphones, speakers, microphones, and other audio equipment. See page 39.
- Mini-DVI port with included Mini-DVI to DVI Adapter and Mini-DVI to VGA Adapter, which let you use your PowerBook with an external monitor or digital flat-panel display, including support for video-mirroring and extended desktop (dual-display) modes. Use a Mini-DVI to Video Adapter (sold separately) for composite or S-video support to connect a television, VCR, or other video device. See page 40.
- Optical drive that allows you to play CDs and DVDs and burn CDs. If you have a SuperDrive, you can burn DVDs as well. See page 43.
- Security slot so that you can make sure your PowerBook stays where it should. See “Security Slot” on page 49.

## Universal Serial Bus (USB)

Your PowerBook comes with two USB 2.0 ports (⌘), also referred to as Hi-Speed USB, which you can use to connect many types of external devices, including printers, scanners, digital cameras, game pads, joysticks, keyboards, and floppy disk drives. Your USB 2.0 ports are compatible with earlier USB devices. In most cases you can connect and disconnect a USB device while the computer is running. Once you connect the device, it is ready to use. You don't need to restart or reconfigure your computer.

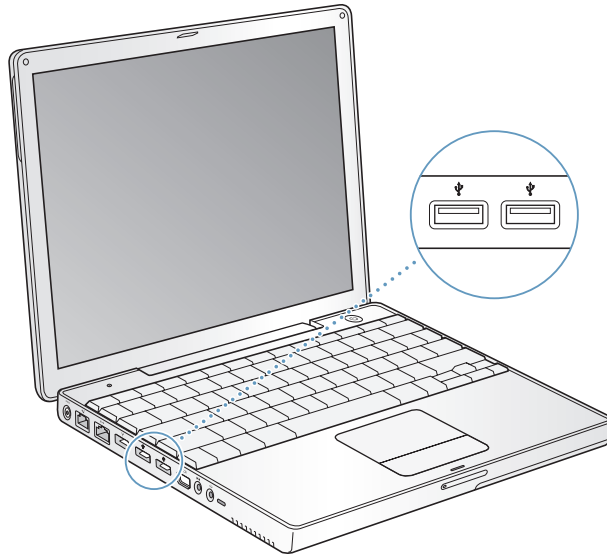

### Using USB Devices

To use a USB device with your computer, simply connect the device to the computer. Your computer automatically loads the correct software whenever you connect a new device.

**Note:** Apple has already included software to work with many USB devices. If your PowerBook cannot find the correct software when you connect a USB device, you can either install the software that came with the device or follow the onscreen prompts to use the Internet to locate, download, and install the correct software.

### USB Devices and Battery Power

You can use USB devices, such as joysticks and keyboards, that get power from the USB connection instead of a separate power adapter. However, these types of USB devices can cause your PowerBook battery to become depleted faster. If you are using the device for an extended period, it is a good idea to connect the PowerBook power adapter.



## Using Multiple USB Devices at the Same Time

If you want to use more than two USB devices at the same time, you can purchase a USB hub. The USB hub connects to an open USB port on your computer and provides additional USB ports (usually four or seven). Most USB hubs also have a power adapter and should be plugged into an outlet.

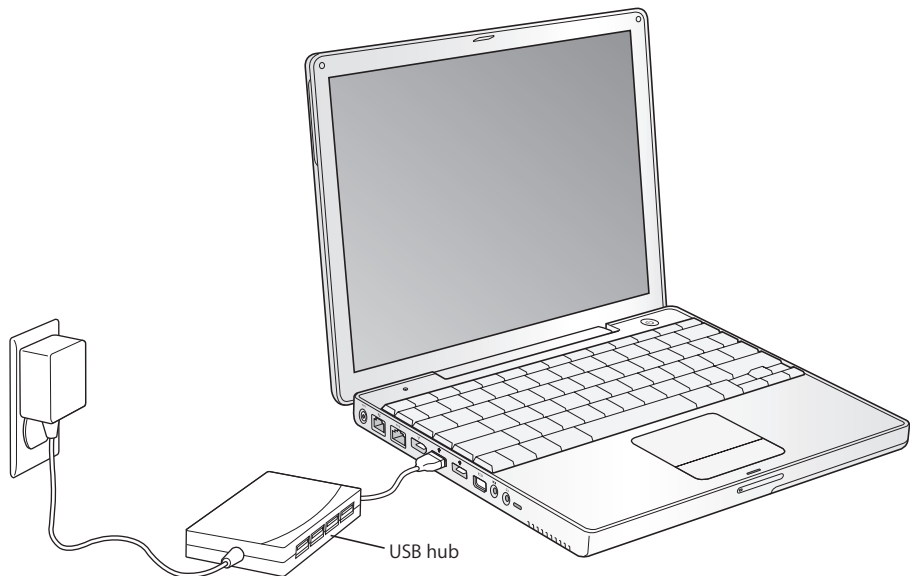

### For More Information on USB

Additional information on USB is available in Mac OS Help. Choose Help > Mac Help in the menu bar and search for “USB.” You can also find information on the Apple USB website at [www.apple.com/usb](http://www.apple.com/usb).

For information on USB devices available for your computer, check the Macintosh Products Guide at [www.apple.com/guide](http://www.apple.com/guide).

## FireWire

Your computer has one FireWire 400 port (🔌). With FireWire, you can easily connect and disconnect external high-speed devices—such as DV cameras, printers, scanners, and hard disks—without restarting your computer.

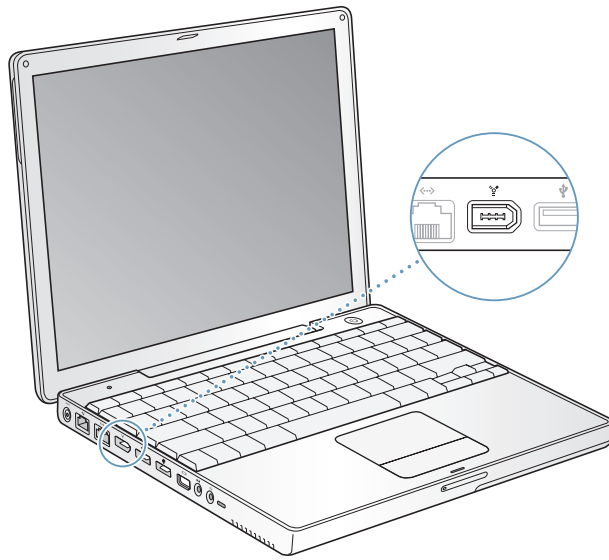

These are some of the things you can do with FireWire:

- Connect a digital videocamera and capture, transfer, and edit high-quality video directly on your computer using video-editing software such as iMovie or Final Cut Pro.
- Connect an external FireWire hard disk drive and use it to back up data or transfer files.
- Start up from an external FireWire hard disk. Connect an external FireWire hard disk (with a valid operating system installed on it), open the Startup Disk pane of System Preferences, and click the FireWire hard disk. Restart your computer.
- Transfer files between your PowerBook and another FireWire-equipped computer using FireWire Target Disk Mode.

### Using FireWire Devices

To use a FireWire device with your computer, connect the device to the computer and install any software that came with the device. Your computer automatically detects newly connected devices.

## FireWire Devices and Battery Power

FireWire devices, such as certain external hard disks, can get power from the PowerBook FireWire connection instead of a separate power adapter. However, these types of FireWire devices can cause your PowerBook battery to become depleted faster. If a device will be connected for an extended period, it is a good idea to connect the PowerBook power adapter.

**Note:** The FireWire port is designed to support power for FireWire devices (up to 7 watts maximum). You can connect multiple devices to each other and connect the “daisy-chain” of devices to the FireWire port on your computer, but only one device should get power from the computer. The rest of the devices in the daisy-chain should be powered by separate power adapters. Connecting more than one FireWire device that gets power from the port may cause problems. If a problem occurs, shut down the computer, remove the FireWire devices, and restart your computer.

## FireWire Target Disk Mode

If you want to transfer files between your PowerBook and another FireWire-equipped computer, or you have a problem that prevents your computer from starting up, you can use FireWire Target Disk Mode to connect to another computer and access your files. When you start up your computer in FireWire Target Disk Mode, the other computer can access your PowerBook as if it were a hard disk.

**Note:** When using FireWire Target Disk Mode, it’s a good idea to connect your power adapter to the PowerBook.

### To connect your PowerBook to another computer in

#### FireWire Target Disk Mode:

- 1 Make sure that your PowerBook is shut down.
- 2 Use a FireWire cable to connect your PowerBook to another FireWire-equipped computer.
- 3 Start up your PowerBook and immediately hold down the T key. Your PowerBook display shows the FireWire logo. The other computer’s display shows the PowerBook internal hard disk icon. You can now drag and drop files between the computers.
- 4 When you are finished transferring files, drag the PowerBook hard disk icon to the Trash.
- 5 Press the Power button on the PowerBook to shut it down, and then disconnect the FireWire cable.

## For More Information on FireWire

Additional information on FireWire is available in Mac OS Help. Choose Help > Mac Help in the Finder menu bar and search for “FireWire.” You can also find information on the Apple FireWire website at [www.apple.com/firewire](http://www.apple.com/firewire).

## Using Bluetooth Devices

Your PowerBook can connect to and transfer information wirelessly to devices that use Bluetooth® wireless technology, such as cell phones and personal digital assistants (PDAs). Bluetooth wireless technology can help eliminate the need for the cables that traditionally connect devices together. Devices with Bluetooth wireless technology can connect to each other wirelessly within a 10-meter (33-foot) range.

Bluetooth wireless technology devices include:

- Computers
- Cell phones
- Peripherals (keyboard, mouse, and so on)
- PDAs

With Bluetooth wireless technology, you can do the following:

- Use your PowerBook to communicate with a mobile phone equipped with Bluetooth wireless technology. Your phone can act as a modem to connect you to a wireless service provider, at speeds of up to 56 kilobits per second (kbit/s), so you can use your mobile phone to access the Internet.
- Communicate with your handheld PDA. Using iSync, you can perform a hot sync operation without cables or send your business card or calendar events directly to a colleague's PDA.
- Transfer files between computers, even Mac to PC, using the transfer utility. Apple still recommends the use of AirPort Extreme wireless networking, however, for anything but the smallest files.

### For More Information on Bluetooth Wireless Technology

You can get help using Bluetooth wireless technology by opening the Bluetooth File Exchange application (located in the Utilities folder within the Applications folder) and choosing Help > Bluetooth Help. You can also find information on the Apple website at [www.apple.com/bluetooth](http://www.apple.com/bluetooth).

## AirPort Extreme Wireless Networking and Internet Access

AirPort Extreme offers an easy and affordable way to provide wireless Internet access anywhere in the home, at work, or in the classroom. Instead of using traditional cables, AirPort Extreme uses wireless local area network (LAN) technology to provide wireless communication between multiple computers. Through a wireless network you can set up access to the Internet, transfer files, play multiplayer games, and more.

The AirPort Extreme Card is compatible with both the Apple AirPort Extreme Base Station and the original Apple AirPort Base Station and any 802.11b or 802.11g compliant products.

**Note:** Wireless Internet access requires an AirPort Extreme Card, AirPort Extreme Base Station or AirPort Base Station, and Internet access (fees may apply). Some Internet service providers are not currently compatible with AirPort. Range may vary with site conditions.

### How AirPort Extreme Provides Wireless Internet Access

With AirPort Extreme, you set up a wireless connection to a device known as a *base station*, which has a physical connection to the Internet. AirPort Extreme technology works like a cordless telephone. The AirPort Extreme Card in the computer makes a wireless connection to the base station, which is connected to the telephone line or a DSL or cable modem.

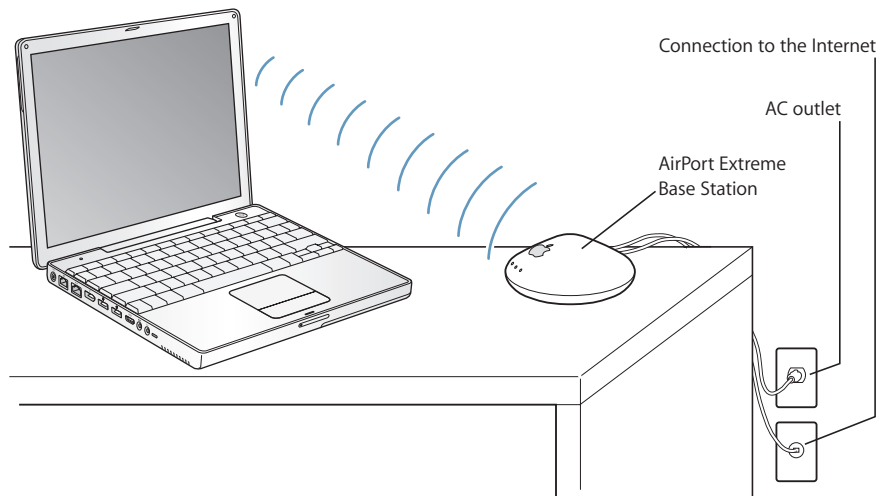

### For More Information on AirPort Extreme

To purchase an AirPort Extreme Base Station, contact your Apple Authorized Reseller or go to the Apple Store at [www.apple.com/store](http://www.apple.com/store).

Additional information on AirPort Extreme is available in AirPort Help. You can also find information on the Apple AirPort website at [www.apple.com/airport](http://www.apple.com/airport) or at [www.apple.com/support](http://www.apple.com/support).

## Ethernet (10/100Base-T)

Your computer comes with built-in 10/100 megabit per second (Mbit/s) twisted-pair Ethernet networking capability, which you can use to connect to a network or to a cable or DSL modem.

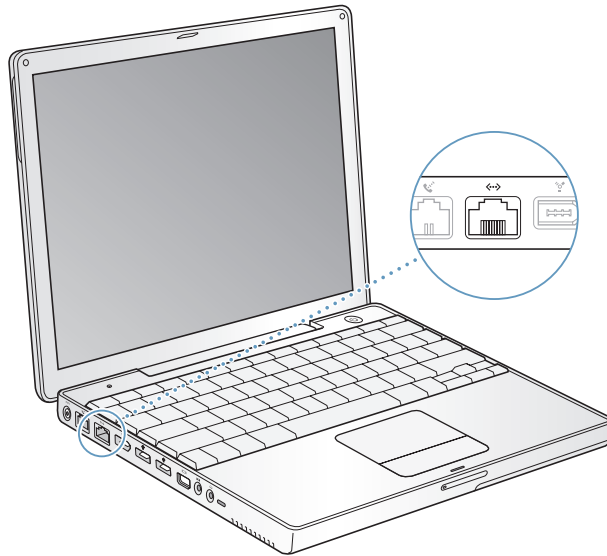

Connecting to a network gives you access to other computers. You may be able to store and retrieve information; use network printers, modems, and email; or connect to the Internet. You can also use Ethernet to share files between two computers or set up a small network. The Ethernet port on your PowerBook automatically detects other Ethernet devices. You don't need an Ethernet crossover cable when connecting to other Ethernet devices.

- Use 2-pair category 3 Ethernet cables to connect to a 10Base-T Ethernet network.
- Use 2-pair category 5 Ethernet cables to connect to a 100Base-T Ethernet network.

### For More Information on Using Ethernet

Additional information, including setting up an Ethernet network and transferring files using Ethernet, is available in Mac OS Help. Choose Help > Mac Help from the menu bar and search for "Ethernet" or "network."

For information on networking products you can use with your PowerBook, check the Macintosh Products Guide at [www.apple.com/guide](http://www.apple.com/guide).

## Using Your Modem

Your Macintosh comes with an Apple 56K internal modem (V.92 compliant) installed. To connect the internal modem, plug one end of the phone cord or RJ-11 cable into the modem port on the back of the computer and the other end into a standard RJ-11 telephone wall jack.

Make sure you connect the internal modem to an analog phone line—the kind used typically in homes. The modem will not work with a digital phone line.

**Warning:** Do not connect a digital telephone line to the modem as it could damage the modem. Contact your telephone service provider if you are unsure whether you have a digital telephone line.

For information on how to establish an Internet connection, see Appendix C, “Connecting to the Internet,” on page 71. More information about the internal modem is also available in Mac OS Help.

## Connecting Speakers and Audio Devices

Your PowerBook comes with three built-in speakers, a built-in microphone, an audio line in port, and a headphone (audio line out) port.

**Note:** While devices are plugged in, sound won’t come through your built-in speakers. Unplug any headphones or speakers to hear the computer speakers.

You can connect external speakers, headphones, and other sound output devices to the headphone port. The headphone port is a stereo 3.5 mini-phono jack.

You can record sound onto your hard disk using the built-in microphone located above the F1 key. You can also connect external microphones or other audio equipment to the audio line in port. The audio line in port is a stereo 3.5 mini-phono jack, which does not provide power to a connected device, so you must use self-powered peripherals. For applications, such as iMovie, that can record sounds, use the Sound pane of System Preferences to select the audio input device you want to use, including microphones connected via USB.

The volume controls on your keyboard allow you to easily change volume. You can also access these controls from the Sound pane of System Preferences.

For more information about using or troubleshooting sound on your computer, open Mac OS Help and search for “sound.”

## External Video Support (DVI, VGA, Composite, and S-Video)

Your computer has a video (mini-DVI) port and adapters that allow you to connect a display or projector with a DVI or VGA connector. Use the included Mini-DVI to DVI Adapter and Mini-DVI to VGA Adapter to connect your PowerBook to monitors and projectors that have DVI or VGA output. You can connect an Apple flat-panel display that has an ADC connector to your PowerBook using an Apple DVI to ADC Display Adapter, which is sold separately.

You can also display and record computer images by connecting a TV, video projector, or videocassette recorder (VCR), or play DVD-Video discs on your television, using a Mini-DVI to Video Adapter (sold separately), which supports composite and S-video connections.

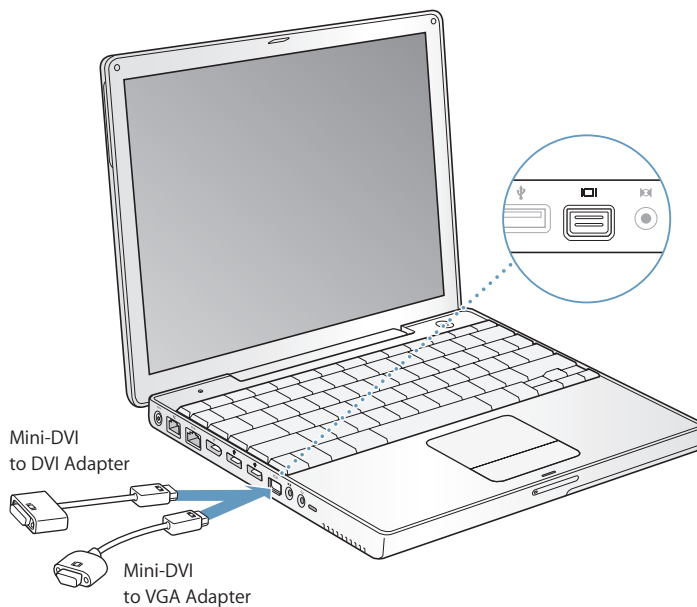

When an external monitor or television is connected, you can either have the same image appear on both the internal display and the external monitor (known as *video-mirroring mode*) or use the external monitor to extend the size of the Mac OS desktop (known as *dual-display mode*). By default, your PowerBook starts up in dual-display mode. Press the F7 () key to switch between dual-display and video-mirroring modes.

If you want sound to come from the external display, such as a projector or TV, you need to connect an audio cable from the computer's headphone (audio line out) port to that device.



**Note:** Because of the display limitations of most televisions, images displayed on the television screen will be of lower quality than those on the built-in display or an external monitor.

## Connecting an External Display or Projector

**To connect an external display or projector with a DVI connector to your computer:**

- 1 Turn on the external display or projector.
- 2 Connect the DVI display cable to your Mini-DVI to DVI Adapter, and then connect the adapter to your PowerBook. Your PowerBook automatically detects the external display.
- 3 Adjust the resolution on the external display by using the Displays pane of System Preferences or by using the Displays icon in the menu bar.

You can connect your PowerBook to an Apple flat-panel display using an Apple DVI to ADC Display Adapter, available from your Apple Authorized Reseller, an Apple retail store, or the Apple Store at [www.apple.com/store](http://www.apple.com/store).

**To connect an Apple flat-panel display with an ADC connector to your computer:**

- 1 Connect the ADC display cable to an Apple DVI to ADC Display Adapter (sold separately). Connect the USB cable of the ADC adapter to your PowerBook, then connect the adapter's power cable to a power outlet.
- 2 Turn on the external display or projector.
- 3 Connect your Mini-DVI to DVI Adapter to the DVI to ADC Display Adapter, and then connect the Mini-DVI to DVI Adapter to your PowerBook. Your PowerBook automatically detects the external display.
- 4 Adjust the resolution on the external display by using the Displays pane of System Preferences or by using the Displays icon in the menu bar.

**To connect an external display or projector with a VGA connector to your computer:**

- 1 Turn on the external display or projector.
- 2 Connect the VGA display cable to the Mini-DVI to VGA Adapter, and then connect the adapter to your PowerBook. Your PowerBook automatically detects the external display.

**Important:** To ensure that your PowerBook automatically detects the external display or projector, be sure the Mini-DVI to VGA Adapter is plugged into the external display or projector first.

- 3 Adjust the resolution on the external display by using the Displays pane of System Preferences or by using the Displays icon in the menu bar.

## Using Your MacBook With the Display Closed

You can use your MacBook with the display closed if the computer is connected to an external monitor, keyboard, and mouse, and the power adapter is plugged into the MacBook and an outlet.

**Important:** To use your MacBook with the display closed, the power adapter must be plugged into the MacBook and an outlet.

**To operate your computer with an external monitor attached and the display closed:**

- 1 Connect a USB keyboard and mouse to your MacBook.
- 2 Connect the power adapter to the MacBook and an outlet.
- 3 Close the MacBook display to put the computer to sleep.
- 4 Follow the steps in the previous section to connect your MacBook to an external display.
- 5 Wait a few seconds and then press any key on the external keyboard to wake the MacBook.

## Connecting a Television, VCR, or Other Video Device

**To connect a TV, VCR, or other video device to the MacBook:**

- 1 Connect a Mini-DVI to Video Adapter (sold separately) to the composite or S-video connector of the TV or other device, then connect the adapter to your MacBook.
- 2 If you want to send the sound from your MacBook to the device, connect a miniplug-to-RCA cable (sold separately) from the headphone (🎧) port on your MacBook to the audio input ports on your device.
- 3 Turn on the external device.
- 4 To adjust how the images are displayed on the device, use the Displays pane of System Preferences.

## For More Information on Using an External Monitor or TV

Additional information on using and configuring an external monitor is available in Mac OS Help. Choose Help > Mac Help from the menu bar and search for “monitor.”

## Using Your Optical Drive

You can install or use software from CDs or DVDs using your optical drive. You can play multimedia on CD discs and music from audio CDs. Your optical drive can write music, documents, and other digital files onto CD-R and CD-RW discs. You can also play DVD movies and use most DVD discs.

If you have a SuperDrive, you can also record information on blank DVD-R (recordable DVD) discs.

**Important:** The optical drive on your PowerBook supports standard circular 12 cm discs. Irregularly shaped discs or discs smaller than 12 cm are not supported. Noncircular discs may become lodged in the drive.

### Inserting a CD or DVD Disc

To install or use programs from a CD or DVD disc:

- 1 With the computer turned on, insert the disc (with the label facing up) into the drive slot until you feel the drive catch the disc and take it the rest of the way in.

The disc may need to be inserted nearly all the way in before the drive takes it in the rest of the way. This is normal.

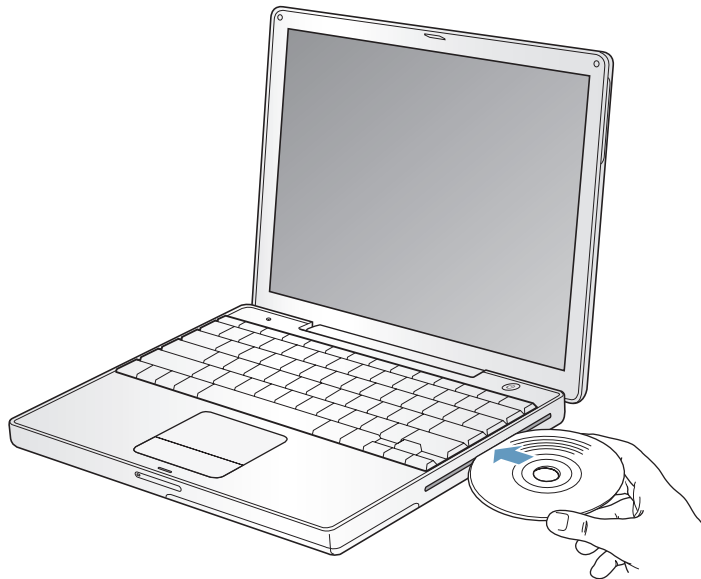

**Note:** Some DVD discs are two-sided. To use the second side, you need to flip the disc over.

- 2 When the icon for the disc appears on the desktop, the disc is ready to use.

## Ejecting a Disc

To eject a disc, do one of the following:

- Drag the disc icon to the Trash.
- Press and hold the Media Eject (⏏) key on the keyboard until the disc ejects.

Allow the disc to fully eject before removing or reinserting it.

If you can't eject the disc, quit any applications that may be using the disc and try again. If that doesn't work, restart the computer while holding down the trackpad button.

## Playing DVD Discs

To play a DVD-Video disc on your PowerBook, insert the DVD disc. DVD Player opens automatically. You'll find DVD Player provides easy-to-use controls for starting, stopping, and viewing DVDs.



If your PowerBook is connected to a TV so that you can watch a DVD-Video on the TV screen, select 720 x 480 NTSC (in the United States) or 720 x 576 PAL (in Europe and other regions) in the Displays pane of System Preferences.

You can easily connect your PowerBook to your stereo system. Use a miniplug-to-RCA cable (not included) to connect the headphone (🔊) port on your PowerBook to the audio input ports on your stereo.

## Recording CD-R and CD-RW Discs

You can record data on CD-R and CD-RW discs.

To record data on a CD-R or CD-RW disc:

- 1 Insert a blank disc into the optical drive.
- 2 In the dialog that appears, enter a name for the disc. An icon for the disc appears on the desktop.
- 3 Drag files and folders to the disc icon.
- 4 Click the Burn Disc icon beside the disc name in the Finder Sidebar.

You can also record music on CD-R or CD-RW discs right from your iTunes library.

**To record music from your iTunes library:**

- 1 Click the iTunes icon in the Dock.
- 2 Select the playlist you want to record.
- 3 Insert a blank CD-R or CD-RW disc.
- 4 At the top of the iTunes window, click Burn CD.

**For More Information**

- For information about how to use iTunes to record music files on a CD-R or CD-RW disc, open iTunes and see the onscreen help.
- For instructions on using DVD Player, open DVD Player and see the onscreen help.

**Recording Information on a DVD**

If you have an optional SuperDrive, you can record your own digital movies on a blank recordable DVD disc. You can also record other kinds of digital data, such as backing up files onto recordable DVD discs.

With applications like iDVD, you can create your own customized digital media project, burn it on a blank recordable DVD disc, and play it on most standard DVD players.

**To burn an iDVD project onto a blank DVD-R disc:**

- 1 Open iDVD and open your completed iDVD project.
- 2 Click the Burn button.
- 3 Insert a blank recordable DVD disc into the drive when prompted.
- 4 Click the Burn button again.

**To record data on DVD-R discs:**

- 1 Insert a blank recordable DVD disc into the drive.
- 2 In the dialog that appears, enter a name for the disc and select the format you want to create. An icon for the DVD appears on the desktop.
- 3 Double-click the DVD icon, then drag files and folders to it.
- 4 Click the Burn Disc icon beside the disc name in the Finder Sidebar.

For more information about how to use iDVD, open iDVD and see the onscreen help.

**Important:** If your battery runs down when you are burning a DVD, the burn may fail and the DVD disc will not be able to be used again. To avoid this, always use your power adapter when burning a DVD.

## Battery

When the external power adapter is not connected, your computer draws power from its battery. Depending on the applications you use and external devices connected to your MacBook, you may find that the length of time that you can run your MacBook off one battery charge varies. Turning off certain features such as AirPort Extreme or Bluetooth® wireless technology can help to conserve battery charge. For more information about using your battery, see “Battery-Conservation Tips” on page 48.

You can determine the charge left in your battery by looking at the battery level indicator lights on the battery itself. Press the button next to the lights and the lights glow to show how much charge is left in the battery. The indicator lights remain lit for a few seconds after you press the button. You can check the charge with the battery in or out of your MacBook.

If your battery runs low while you are working, you can shut down your MacBook and replace the battery with a charged one.

**Important:** If only one flashing light is on, very little charge is left. If no lights are visible, the battery is completely drained and the computer will not start up unless the power adapter is connected. Plug in the power adapter to let the battery recharge, or replace the drained battery with a fully charged battery (see page 47).

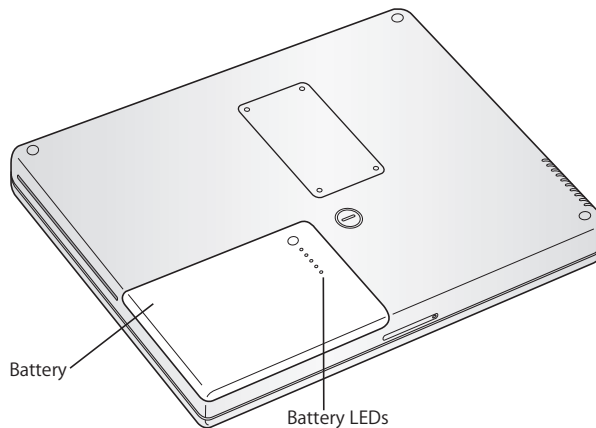

If the battery icon in the Finder menu bar is set to show the percentage of charge, you may sometimes notice that the battery does not maintain a full charge of 100% when the power adapter is attached. When the battery level eventually drops below 95 percent, it will charge all the way to 100 percent. This saves battery life as charging is not continuously cycled on and off.

## Removing and Replacing the Battery

### To remove the battery:

- Shut down your PowerBook. Turn it over and locate the battery latch. Use a coin to turn the latch a quarter turn clockwise to unlock the battery, and gently remove it.

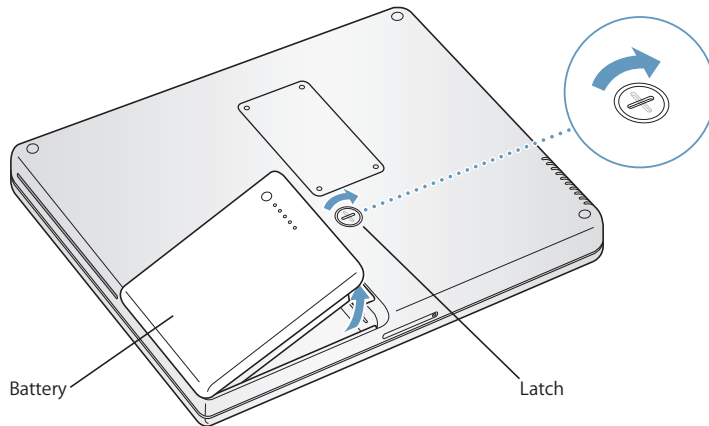

### To replace the battery:

- Place the left side of the battery into the battery compartment. Gently press the right side of the battery down until the battery latch locks into place.

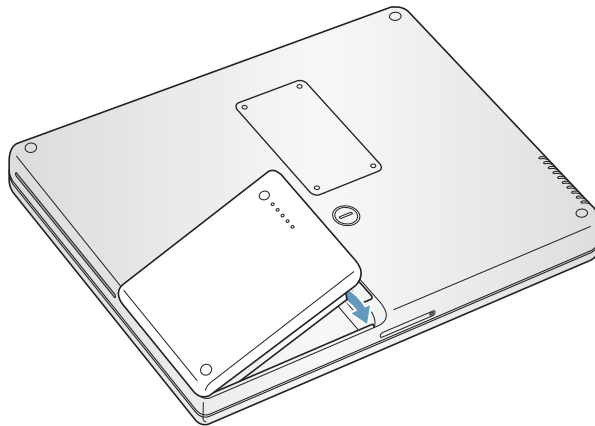

**Note:** Dispose of batteries according to your local environmental laws and guidelines. For more information, see “Battery Disposal Information” on page 94.

## Charging a Battery

When the power adapter that came with your computer is connected, the battery recharges whether the computer is off, on, or in sleep. However, the battery recharges more quickly if the computer is off or in sleep. You can monitor the battery charge level using the Battery status icon in the menu bar.

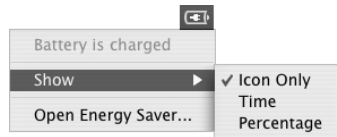

The battery charge level displayed is based on the amount of power left in the battery with the applications, peripheral devices, and system settings (display brightness, Energy Saver settings, and so on) you are currently using. To make more battery power available, close applications and disconnect peripheral devices not in use, and adjust your Energy Saver settings (see the next section).

## Battery-Conservation Tips

The amount of work time your PowerBook battery can provide before you need to recharge depends on the applications and peripheral devices you're currently using and the steps you take to conserve power while you work.

### For the best conservation of battery power, do the following:

- Disconnect bus-powered USB or FireWire devices when they are not in use.
- If you have an AirPort Extreme Card installed, turn AirPort off when not in use (use the AirPort status icon in the menu bar).
- Turn off Bluetooth wireless technology when not in use.
- Quit open applications that you are not using.
- Remove CD and DVD discs when they are not in use.
- Reduce screen brightness using the brightness controls on the PowerBook keyboard.
- Set the hard disk to spin down after a short time. In the Energy Saver pane of System Preferences, select the "Put the hard disk to sleep when possible" option.
- Set your PowerBook to sleep after inactivity of five minutes or less.



To further save battery power, select the following options in the Energy Saver pane of System Preferences:

- Set your computer to modify its processor speed based upon the required amount of processing activity. You can set your PowerBook to automatically reduce its processing speed during periods of light processing activity, thus reducing power usage. During periods of high processing activity, your computer will automatically switch to a higher processing speed. In the Energy Saver pane of System Preferences, click Show Details to see the settings. Choose Battery Power from the “Settings for” pop-up menu, click Options, and choose Automatic from the Processor Performance pop-up menu. (To set your computer to use its highest processing speed at all times, choose Highest from the Processor Performance pop-up menu.)
- To conserve battery life the longest, choose Longest Battery Life from the Optimize Energy Settings pop-up menu.

### For More Information on Your PowerBook Battery

Additional information is available in Mac OS Help. Choose Help > Mac Help from the menu bar and search for “battery.”

### Security Slot

You can purchase a security cable lock to protect your PowerBook. With a lock, you can secure your computer to a desk or table.

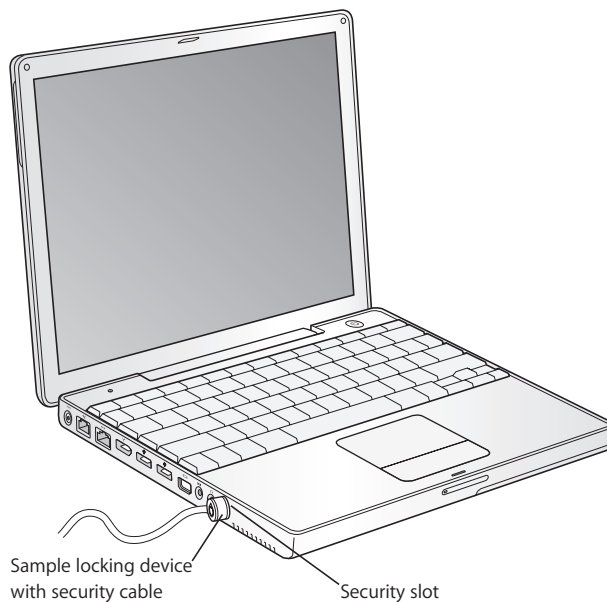

### For More Information on Security Options

Additional information on the software security features of your PowerBook, including multiple user passwords and file encryption, is available in Mac OS Help. Choose Help > Mac Help from the menu bar and search for “security” or “multiple users.”

This chapter provides information and instructions for installing additional memory in your PowerBook

**Warning:** Apple recommends that you have an Apple-certified technician install memory. Consult the service and support information that came with your computer for instructions on how to contact Apple for service. If you attempt to install memory and damage your equipment, such damage is not covered by the limited warranty on your computer.

## Installing Additional Memory

Your computer comes with one memory slot that you access by turning your computer over and removing the four screws that secure the memory slot door. Your computer comes with 256 megabytes (MB) of Double Data Rate (DDR) Synchronous Dynamic Random-Access Memory (SDRAM) installed on the logic board. The memory slot can accept an SDRAM module that meets the following specifications:

- Double Data Rate Small Outline Dual Inline Memory Module (DDR SO-DIMM) format
- 1.25 inch or smaller
- 256, 512 MB, or 1 gigabyte (GB)
- 200-pin
- PC2700 DDR 333 Type RAM

The maximum amount of memory you can install in your PowerBook is 1.25 GB, using one 1 GB DIMM in the memory slot.

**To install additional memory:**

- 1 Shut down your computer. Disconnect the power adapter, phone cord, and any other cables connected to the computer. Turn the computer over and remove the battery by giving the latch a quarter turn.

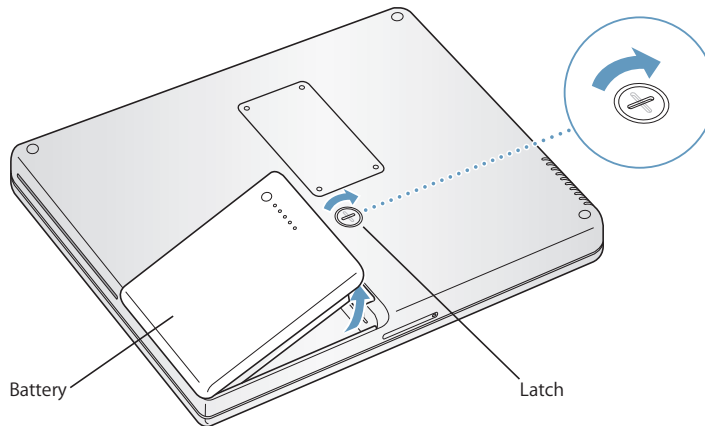

**Warning:** The internal components of your PowerBook may be hot. If you have been using your PowerBook, wait 10 minutes after shutting down to let the internal components cool before continuing.

- 2 Using a Phillips size 00 screwdriver, unscrew the memory slot door and remove it from the bottom of your computer.

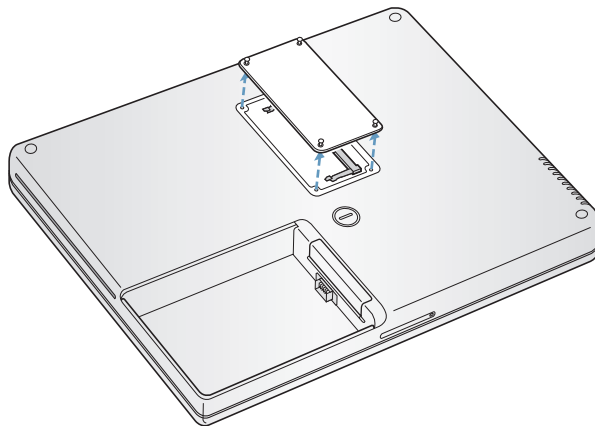

- 3 Touch a metal surface inside the computer to discharge any static electricity from your body.

- 4 If you already have a memory card installed in the slot, remove it. Spread the tabs in the slot away from the notches in the memory card. The card should pop up slightly.

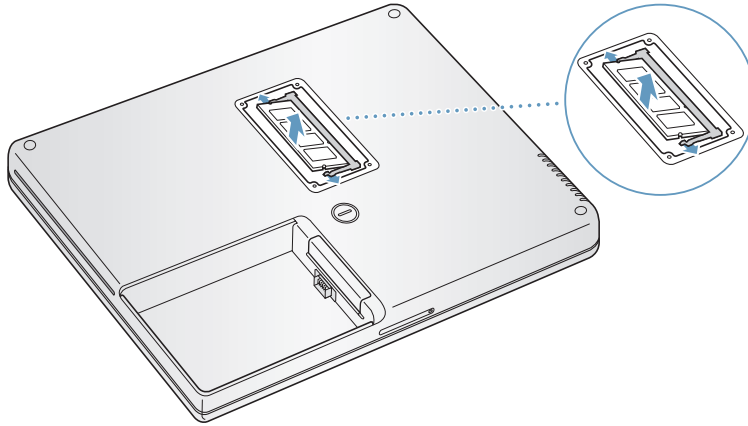

- 5 Insert the new memory card into the slot at a 30-degree angle. Push the card to seat it fully into the slot.

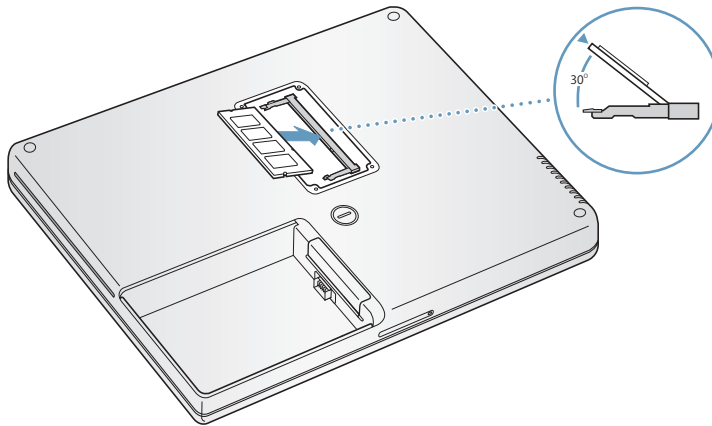

- 6 Press down on the memory card to lock it in place. If the memory card does not latch, do not force the card down. Try reinserting the card to make sure it is fully seated.

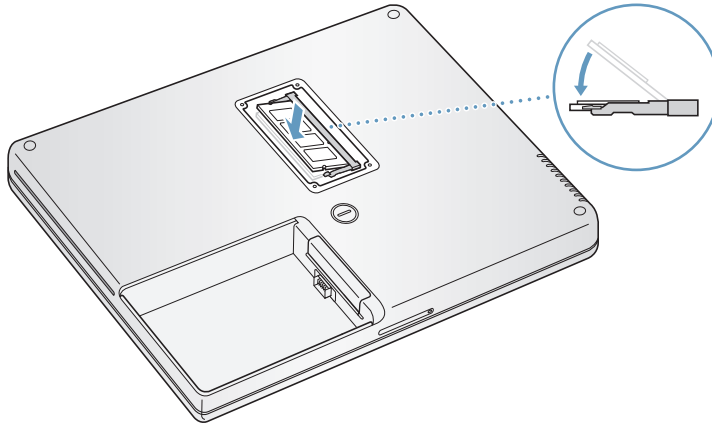

- 7 Replace the memory slot door and screw it into place.

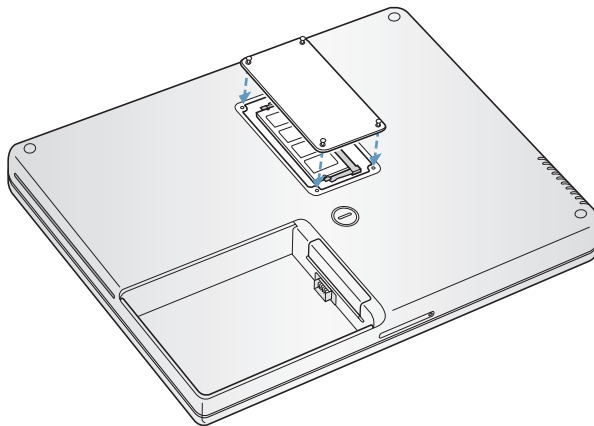

**Note:** To avoid damage, be careful not to overtighten the screws.

- 8 Replace the battery. Place the left side of the battery into the battery compartment. Gently press the right side of the battery down until the battery latch locks into place.

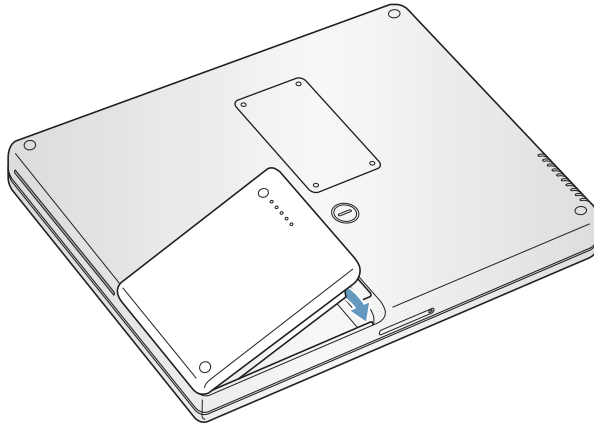

- 9 Reconnect the power adapter and any other cables that were attached.

### Making Sure Your Computer Recognizes the New Memory

After installing additional memory in your PowerBook, check whether the computer recognizes the new memory.

- 1 Start up your computer.
- 2 When you see the Mac OS desktop, choose Apple () > About This Mac from the menu bar.

The dialog that appears shows the total amount of memory installed in the computer. For a more detailed breakdown of the amount of memory installed in your computer, click the More Info button.

If the memory is not recognized or your computer does not start up correctly, shut down your PowerBook and check the instructions again to make sure that the memory you installed is compatible with this PowerBook and that it is installed correctly. If you still have problems, remove the memory and consult the support information that came with the memory or contact the vendor who provided the memory.





## If you have a problem working with your PowerBook, check here first for solutions and advice.

When you experience a problem, there is usually a simple and quick solution. Be aware of the conditions that led up to the problem. Making a note of things you did before the problem occurred will help you narrow down possible causes and then find the answers you need.

Things to note include:

- The applications you were using when the problem occurred. Problems that occur only with a specific application may indicate that the application is not compatible with the version of the Mac OS installed on your computer.
- Any software that you recently installed, especially software that added items to the System folder. (Certain applications install extensions that may not be compatible with the Classic environment.)
- Any new hardware, such as additional memory or a peripheral, that you installed.

You can also find more troubleshooting information in Mac OS Help, on the Apple Support website at [www.apple.com/support](http://www.apple.com/support), and in the AppleCare Knowledge Base at [kbase.info.apple.com](http://kbase.info.apple.com).

## Problems That Prevent You From Using Your Computer

### If the computer won't respond or the pointer won't move

- Press Command (⌘)-Option-Esc to force a frozen application to quit. If a dialog appears, select the application you would like to quit and click Force Quit.  
If you are working in Classic, hold down the Option and Command (⌘) keys and then press the Esc key.  
Next, save your work in any open applications and restart the computer to be sure the problem is entirely cleared up.
- If you are unable to force the application to quit, press and hold the Power button (⏻) for a few seconds to shut down the computer.
- If the computer still doesn't respond, try to restart it by simultaneously pressing the Command (⌘) and Control keys on your keyboard and the Power button (⏻).

*If the problem occurs frequently*, choose Help > Mac Help from the menu bar at the top of the screen. Search for the word “freeze” to see help for instances when the computer freezes or doesn't respond.

*If the problem occurs only when you use a particular program*, check with the program's manufacturer to see if it is compatible with your computer. If you know an application is compatible, you may need to reinstall your computer's system software or, if you're using Classic, you may need to check for incompatible system extensions. See the next topic for instructions.

### If the computer freezes during startup or you see a flashing question mark

Try using Disk Utility to repair your hard disk.

- 1 Insert the first software install and restore disc into your computer. Then restart your computer and hold down the C key as it starts up.
- 2 Choose Installer > Open Disk Utility. When Disk Utility opens, follow the instructions in the First Aid pane to see if the utility can repair your disk.

If using Disk Utility doesn't work, you may need to reinstall your computer's system software. For instructions, see page 61.

*If you are using the Classic environment in Mac OS X*, you might have an incompatible extension. (Mac OS X does not use system extensions.)

Try turning off your system extensions to see if that solves the problem. To turn off extensions in Classic, open System Preferences, click Classic, click the Advanced tab, and choose Turn Off Extensions from the pop-up menu. Click Restart Classic.

If turning off extensions appears to solve the problem, you may need to identify and eliminate or reinstall the extension that is causing the problem. Open the Extensions Manager control panel and turn off the extensions you suspect are causing the problem. Then restart Classic with the extensions turned on again.

### **If the computer won't turn on or start up**

- Make sure the power adapter is plugged into the computer and into a functioning power outlet. Be sure to use the power adapter that came with your computer.
- Check if your battery needs to be recharged. Press the small button on the battery. You should see one to four lights indicating the battery's level of charge. If only one battery level indicator light is flashing, allow the power adapter to charge the battery until at least one indicator light is glowing continuously.
- If that does not work, press the Power button (⏻) and immediately hold down the Command (⌘), Option, P, and R keys until you hear the startup sound a second time.
- If you recently installed additional memory, make sure that it is correctly installed and that it is compatible with your computer. See whether removing it allows the computer to start up (see page 51).
- If you are still unable to start up your computer, see the service and support information that came with your PowerBook for information on contacting Apple for service.

### **If the display suddenly goes black or your system freezes**

Try restarting your system.

- 1 Unplug any devices that are connected to your PowerBook except the power adapter.
- 2 Hold down the Command (⌘) and Control keys and press the Power button (⏻) to restart the system.
- 3 Let the battery charge to at least 10 percent before plugging in any external devices and resuming your work.

To see how much the battery has recharged, look at the Battery status icon in the menu bar.

## **Other Problems**

### **If you forgot your password**

- 1 Insert the first software install and restore disc into your computer. Then restart your computer and hold down the C key as it starts up.
- 2 Choose Installer > Reset Password from the menu bar. Follow the instructions on the screen.

### **If you have a problem with an application**

- For problems with software from a manufacturer other than Apple, contact the manufacturer.  
Software manufacturers often provide software updates on their websites.
- You can configure your PowerBook to automatically check for and install the latest Apple software using the Software Update pane of System Preferences. For more information, choose Help > Mac Help from the menu bar and search for "Software Update."

### **If you have trouble using AirPort Extreme wireless communication**

- Make sure you have properly configured the software according to the instructions that came with your AirPort Extreme Card or base station.
- Make sure the computer or network you are trying to connect to is running and has a wireless access point.
- Make sure you are within antenna range of the other computer or the network's access point.

Nearby electronic devices or metal structures can interfere with wireless communication and reduce this range. Repositioning or rotating the computer may improve reception.

- Check the AirPort Extreme signal level.

Check the AirPort status icon in the menu bar. Up to four bars appear to show signal strength.

- See AirPort Help (choose Help > Mac Help, then choose Library > AirPort Help from the menu bar) and the instructions that came with the wireless device for more information.

### **If you have trouble ejecting a disc**

- Quit any applications that may be using the disc and try again. If that doesn't work, restart the computer while holding down the trackpad button.

### **If you suspect a problem with your computer hardware**

- You can use the Apple Hardware Test application to help determine if there is a problem with one of your computer's components, such as the memory or processor. Apple Hardware Test is on the first software install and restore disc.

#### **To use Apple Hardware Test:**



- 1 Disconnect all external devices from your computer. If you have an Ethernet cable connected, disconnect it.
- 2 Start up your computer using Apple Hardware Test. Insert the first software install and restore disc into your computer. Then restart your computer and hold down the Option key as it starts up.

A list of available startup volumes appears. Click Apple Hardware Test and click the right arrow.

- 3 When the Apple Hardware Test main screen appears, follow the onscreen instructions.
- 4 If Apple Hardware Test detects a problem, it displays an error code. Make a note of the error code before pursuing support options. If Apple Hardware Test does not detect a hardware failure, the problem may be software-related.

For more information about Apple Hardware Test, see the Apple Hardware Test Read Me file on the first software install and restore disc.

### **If you have problems with your Internet connection**

- Make sure your telephone line or network cable is connected and functioning properly.
- If you are using a dial-up Internet connection, make sure that your telephone cord is plugged into the modem port (marked with the  icon) and not the Ethernet port (marked with the  icon) on the computer.
- Open the Network pane of System Preferences and verify the information entered there with your Internet service provider (ISP) or network administrator.

### **If you have a problem using your computer or working with the Mac OS**

- If the answers to your questions are not in this manual, look in Mac OS Help for instructions and troubleshooting information.
- Check the Apple Support website at [www.apple.com/support](http://www.apple.com/support) for the latest troubleshooting information and software updates.

## Restoring Your Computer's Software

Use the software install and restore discs that came with your computer to install Mac OS X, applications, and Classic support.

### **To install Mac OS X:**

- 1 Back up essential files, if possible.
- 2 Insert the first software install and restore disc that came with your computer.
- 3 Double-click the "Install Mac OS X" icon.
- 4 Follow the onscreen instructions.

**Note:** If you're experiencing problems and the computer won't start up, try using FireWire Target Disk Mode to transfer files to another computer (see page 35). Then restart the computer by inserting the first software install and restore disc into the optical drive and restarting the computer.

### **To install applications and Classic support:**

- 1 Back up essential files, if possible.
- 2 Insert the first software install and restore disc that came with your computer.
- 3 Double-click the "Install Applications and Classic Support" icon.
- 4 Follow the onscreen instructions.

**Note:** iCal, iChat, iMovie, iPhoto, iSync, iTunes, and Safari are part of Mac OS X. To install them you must follow the instructions for installing Mac OS X.

## Locating Your Product Serial Number

You can see your computer's serial number by choosing About This Mac from the Apple (🍏) menu and then clicking the More Info button, or by opening System Profiler (in Applications/Utilities) and clicking Hardware. The serial number for your PowerBook is also located in the battery bay.

You can use System Profiler to find out detailed information about your PowerBook, such as the amount of built-in memory, hard disk size, devices connected, and the product serial number.

To access the information in System Profiler, choose Apple () > About This Mac from the menu bar and then click More Info, or open System Profiler, located in Applications/Utilities.

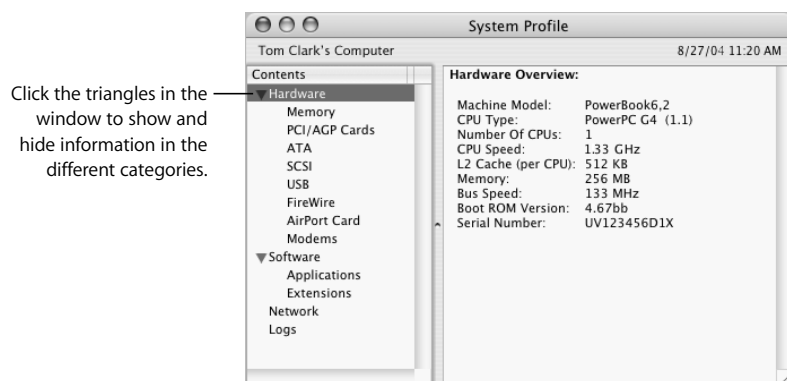

## Operating Environment

- Operating temperature: 50° F to 95° F (10° C to 35° C)
- Altitude: 3048 m (10,000 ft.) maximum
- Relative humidity: 20% to 80% noncondensing

## Power Adapter

- Input: AC 100–240 volts (V), 50/60 hertz (Hz)
- Output: DC 24.5 V, 1.875 A

## Battery

- Output: DC 10.8 V
- Capacity: 50 WHr

Additional information is available on the Internet at [www.apple.com/powerbook](http://www.apple.com/powerbook) and [www.apple.com/support](http://www.apple.com/support).



Read this important PowerBook safety and maintenance information.

## Cleaning Your PowerBook

Follow these general rules when cleaning the outside of your computer and its components:

- Shut down your PowerBook and remove the battery.
- Use a damp, soft, lint-free cloth to clean the computer's exterior. Avoid getting moisture in any openings. Do not spray liquid directly on the computer.
- Don't use aerosol sprays, solvents, or abrasives.

## Cleaning Your PowerBook Display

To clean your PowerBook screen, do the following:

- Shut down your PowerBook and remove the battery.
- Dampen a clean, soft, lint-free cloth or paper with water only and wipe the screen. Do not spray liquid directly on the screen.

## Carrying Your PowerBook

If you carry your PowerBook in a bag or briefcase, make sure that there are no loose items (such as paper clips or coins) that could accidentally get inside the computer through an opening such as the optical drive slot.

## Storing Your PowerBook

If you are going to store your PowerBook for an extended period of time, do one of the following to prevent your PowerBook battery from becoming completely depleted:

- Keep the power adapter connected.
- Fully charge your PowerBook battery before storing the computer.
- Fully charge and then remove your PowerBook battery when storing your computer (especially important when storing your computer for longer than 5 months).

## Safety Instructions for Setting Up and Using Your Computer

### Plugging In the Power Adapter

Always leave space around your power adapter. Do not use this equipment in a location where airflow around the power adapter or computer is confined. Always disconnect the power adapter and remove the battery before opening the computer to perform procedures such as installing memory or removing the hard disk.

**Warning:** Use only the power adapter that came with your PowerBook computer. Adapters for other electronic devices (including other PowerBook models and other portable computers) may look similar, but they may affect your computer's performance or damage it.

### Connecting a Phone Line to the Internal Modem

Always disconnect the phone cord before opening the computer to perform procedures such as installing memory or removing the hard disk.

**Warning:** Do not connect a digital telephone line to the modem, because the wrong type of line could damage the modem.

### Using Your PowerBook

When using your PowerBook or when charging the battery, it is normal for the bottom of the case to get warm. For prolonged use, place your PowerBook on a flat, stable surface. The bottom of the PowerBook case functions as a cooling surface that transfers heat from inside the computer to the cooler air outside. The bottom of the case is raised slightly to allow airflow that keeps the unit within normal operating temperatures. In addition, the computer vents warm air from the back of the case.

**Warning:** Do not place your PowerBook on a pillow or other soft material when it is on, as the material may block the airflow vents, in particular the rear vents, and cause the computer to overheat. Never place anything over your keyboard before closing the display. This can cause your computer to cycle on and off which may create excessive heat and drain your battery. Never turn on your computer unless all of its internal and external parts are in place. Operating the computer when it is open or missing parts can be dangerous and can damage your computer.

## General Safety Instructions

For your own safety and that of your equipment, always take the following precautions.

Disconnect the power plug (by pulling the plug, not the cord), remove the main battery, and disconnect the phone cord if any of the following conditions exists:

- You want to remove any parts.
- The power cord or plug becomes frayed or otherwise damaged.
- You spill something into the case.
- Your computer is exposed to rain or any other excess moisture.
- Your computer has been dropped or the case has been otherwise damaged.
- You suspect that your computer needs service or repair.
- You want to clean the case (use only the recommended procedure described earlier).

**Important:** The only way to disconnect power completely is to unplug the power cord and phone cord, and remove the battery. Make sure at least one end of the power cord is within easy reach so that you can unplug the computer when you need to.

**Warning:** Your AC cord came equipped with a three-wire grounding plug (a plug that has a third grounding pin). This plug will fit only a grounded AC outlet. If you are unable to insert the plug into an outlet because the outlet is not grounded, contact a licensed electrician to replace the outlet with a properly grounded outlet. Do not defeat the purpose of the grounding plug.

Be sure that you always do the following:

- Keep your computer away from sources of liquids, such as drinks, washbasins, bathtubs, shower stalls, and so on.
- Protect your computer from dampness or wet weather, such as rain, snow, and so on.
- Read all the installation instructions carefully before you plug your computer into a wall socket.
- Keep these instructions handy for reference by you and others.
- Follow all instructions and warnings dealing with your system.

**Important:** Electrical equipment may be hazardous if misused. Operation of this product, or similar products, must always be supervised by an adult. Do not allow children access to the interior of any electrical product and do not permit them to handle any cables.

**Warning:** Never push objects of any kind into this product through the openings in the case. Doing so may be dangerous and may result in fire or electric shock.

## Battery

**Warning:** There is risk of explosion if the battery is replaced by an incorrect type. Dispose of used batteries according to your local environmental guidelines. Don't puncture or incinerate the battery.

## Connectors and Ports

Never force a connector into a port. If the connector and port don't join with reasonable ease, they probably don't match. Make sure that the connector matches the port and that you have positioned the connector correctly in relation to the port.

## Avoid Hearing Damage

**Warning:** Permanent hearing loss may occur if earbuds or headphones are used at high volume. You can adapt over time to a higher volume of sound, which may sound normal but can be damaging to your hearing. Set your PowerBook volume to a safe level before that happens. If you experience ringing in your ears, reduce the volume or discontinue use of earbuds or headphones with your PowerBook.

## Apple and the Environment

Apple Computer recognizes its responsibility to minimize the environmental impacts of its operations and products.

### For More Information

Go to [www.apple.com/about/environment](http://www.apple.com/about/environment).

## Ergonomics

Here are some tips for setting up a healthy work environment.

### Keyboard and Trackpad

When you use the keyboard and trackpad, your shoulders should be relaxed. Your upper arm and forearm should form an angle that is slightly greater than a right angle, with your wrist and hand in roughly a straight line.

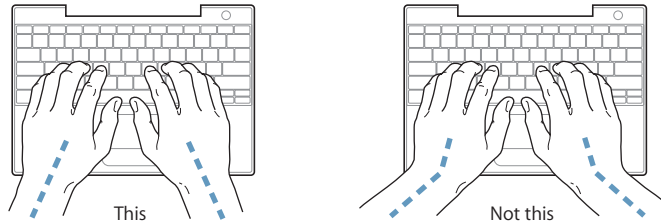

Use a light touch when typing or using the trackpad and keep your hands and fingers relaxed. Avoid rolling your thumbs under your palms.

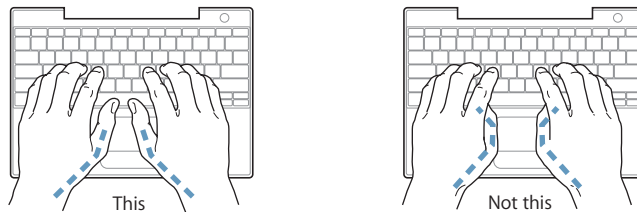

Change hand positions often to avoid fatigue. Some computer users may develop discomfort in their hands, wrists, or arms after intensive work without breaks. If you begin to develop chronic pain or discomfort in your hands, wrists, or arms, consult a qualified health specialist.

### **Chair**

An adjustable chair that provides firm, comfortable support is best. Adjust the height of the chair so your thighs are horizontal and your feet flat on the floor. The back of the chair should support your lower back (lumbar region). Follow the manufacturer's instructions for adjusting the backrest to fit your body properly.

You may have to raise your chair so your forearms and hands are at the proper angle to the keyboard. If this makes it impossible to rest your feet flat on the floor, you can use a footrest with adjustable height and tilt to make up for any gap between the floor and your feet. Or you may lower the desktop to eliminate the need for a footrest. Another option is to use a desk with a keyboard tray that's lower than the regular work surface.

### **External Mouse**

If you use an external mouse, position the mouse at the same height as your keyboard and within a comfortable reach.

### **Built-in Display**

Adjust the angle of the display to minimize glare and reflections from overhead lights and windows. Do not force the display if you meet resistance. The display is not meant to open past 140 degrees.

You can adjust the brightness of the screen when you take the computer from one work location to another, or if the lighting in your work area changes.

### **For More Information**

Go to [www.apple.com/about/ergonomics](http://www.apple.com/about/ergonomics).

You can use your computer to browse the World Wide Web, send email to friends and family, and chat in real time over the Internet. Use this detailed guide to connect to the Internet.

When you first start up Mac OS X, Setup Assistant helps you enter your Internet configuration information and sign up for an Internet service provider (ISP) if you don't already have one.

If you didn't use Setup Assistant to configure your Internet connection, you can use it now. Open System Preferences and click Network. Click the "Assist me" button to open Network Setup Assistant. If you don't want to use Network Setup Assistant, you can use the information in this appendix to set up your connection manually.

**There are four kinds of Internet connections:**

- **Dial-up connection:** Your computer is plugged into a telephone wall jack using a telephone cable (with computers that include a modem).
- **High-speed DSL or cable modem connection:** Your computer is plugged into a special modem you get from an ISP using an Ethernet cable.
- **AirPort Extreme wireless connection:** Your computer is connected wirelessly to the Internet using an AirPort Extreme Base Station.
- **Local area network (LAN):** Your computer is plugged into a LAN using an Ethernet cable. This type of connection is usually used in the workplace.

**Before you connect to the Internet:**

- 1 Set up an account with an ISP. If you do not have an ISP account, Setup Assistant can help you get one. If you don't want to use the ISP suggested by Setup Assistant, you can find an ISP in your phone directory. Look under "Internet access," "Internet service," or "online."

**Note:** If you want to use America Online as your ISP, skip the Internet setup part of Setup Assistant.

- 2 Gather the connection information you need from your ISP or network administrator. See the next section, "Gathering the Information You Need," to find out what information to get for each type of connection.

If another computer in the same location is already connected to the Internet, you may be able to use its settings.

**To find the settings on a Mac OS X computer:**

- Open the Network pane of System Preferences.
- Choose your connection method from the Show pop-up menu.
- Copy the information for your configuration.

**To find the settings on a Mac OS 9 computer:**

- Open the TCP/IP control panel.
- Find the connection method in the "Connect via" pop-up menu.
- Find the configuration in the Configure pop-up menu.
- Copy the IP address, subnet mask, and router address from the corresponding fields.

**To find the settings on a Windows PC:**

The connection information on a Windows computer resides in two places.

- To find the IP address and subnet mask, open the "Network and Internet Connections" control panel.
- To find user account information, open the User Accounts control panel.

You can write the information directly on the next few pages, then enter it in Setup Assistant.

- 3 If you are using a dial-up modem, plug the phone cord (included with most Macintosh computers) into your computer's modem port and into a phone wall jack. If you are using a DSL or cable modem, follow the instructions that came with the modem to connect it to your computer.



## Gathering the Information You Need

You can write the information you get from your Internet service provider (ISP), your network administrator, or your other computer on these pages, then enter it in Network Setup Assistant.

### To set up a telephone dial-up connection, gather the following information:

- Service provider name
- User or account name
- Password
- ISP phone number
- Alternate phone number
- Dialing prefix to obtain an outside line

### To set up a DSL, cable modem, LAN, or AirPort Extreme wireless connection:

- First, choose your connection method (ask your system administrator or your ISP, if you don't know):
  - Manually
  - Using DHCP with a manual address
  - Using DHCP
  - Using BootP
  - PPP

If you're unsure which method to use, "Using DHCP" may be a good choice, because the network supplies most of the required information for you automatically.

If you selected "Manually" or "Using DHCP with a manual address," gather the following:

- IP address
- Subnet mask
- Router address

**Note:** If you selected "Using DHCP with a manual address," you don't need a subnet mask or router address.

If you selected "Using DHCP," gather the following optional information (ask your ISP if you need it):

- DHCP client ID
- DNS servers

If you selected “PPP” (for PPPoE connections), gather the following:

- Service provider
- Account name
- Password
- PPPoE service name

The information below is optional. Ask your ISP or system administrator if you need it.

- DNS servers
- Domain name
- Proxy server

## Entering Your Information

After gathering your specific setup information from your ISP or network administrator, you can click the “Assist me” button in the Network preferences pane to open Network Setup Assistant, or you can enter the information manually.

To enter your information manually, follow the steps that correspond to your connection method.

- Dial-up modem with Point-to-Point Protocol (PPP) connection (see page 75)
- Cable modem, DSL, or LAN connection using these configurations:
  - Manual (see page 79)
  - DHCP (see page 80)
  - PPPoE (see page 81)
- AirPort Extreme wireless connection (see page 83)

## Dial-Up Modem With Point-to-Point Protocol (PPP) Connections

A dial-up modem is the most common way to connect to the Internet. Your modem uses a method called Point-to-Point Protocol (PPP) to connect to an ISP.

Make sure your modem is plugged into a phone line and you have the information from your ISP available (see page 73).

**To set up Network preferences to connect using the internal modem port:**

- 1 Choose Apple () > System Preferences from the menu bar.
- 2 Click Network.
- 3 Choose Network Port Configurations from the Show pop-up menu and select the On checkbox next to Internal Modem.



- 4 Drag Internal Modem to the top of the Port Configurations list to make it the preferred, or primary, network interface.

- 5 Choose Internal Modem from the Show pop-up menu and click PPP.
- 6 Enter the information from your ISP and click Apply Now.



#### To test your Internet configuration:

- 1 Open the Internet Connect application (in the Applications folder).
- 2 Click the Internal Modem icon, if necessary.
- 3 Enter your dial-up telephone number, account name, and password, if necessary.
- 4 Click Connect.

Internet Connect dials your ISP and establishes a connection.

To connect automatically when you start a TCP/IP application, such as a web browser or email:

- 1 Click PPP Options (in the PPP pane of Network preferences).
- 2 Select the “Connect automatically when needed” checkbox.



- 3 Click OK and Apply Now.

## DSL, Cable Modem, or LAN Internet Connections

If you connect to the Internet using a DSL or cable modem or Ethernet LAN, ask your ISP or network administrator how you should configure your Internet connection:

- Manually. With a manual configuration, your ISP or network administrator provides a static IP address and other information that you enter in Network preferences.
- Using Dynamic Host Configuration Protocol (DHCP). With a DHCP configuration, the DHCP server automatically enters the information for you.
- Using Point-to-Point Protocol over Ethernet (PPPoE). If you use a DSL modem and need a user name and password to connect to the Internet, you may need to configure your network to use PPPoE.

Make sure you have the information from your ISP available as you configure your network (see page 73).

**To set up Network preferences for the built-in Ethernet port:**

- 1 Choose Apple (🍏) > System Preferences from the menu bar.
- 2 Click Network.
- 3 Choose Network Port Configurations from the Show pop-up menu.
- 4 Select the On checkbox next to Built-in Ethernet.



- 5 Drag Built-in Ethernet to the top of the Port Configurations list to make it the preferred, or primary, network interface.

Next, follow the instructions to configure your network manually, using DHCP, or using PPPoE, as instructed by your ISP or network administrator.

## Manual Configuration

Have your static IP address, router address, and subnet mask from your ISP ready (see page 73).

**To set up a manual configuration:**

- 1 In Network preferences, choose Built-in Ethernet from the Show pop-up menu.
- 2 Click TCP/IP, if necessary.
- 3 In the Configure IPv4 pop-up menu, choose Manually.



- 4 Type the information into the corresponding fields.
- 5 Click Apply Now.

Once you configure your network, your connection is ready. Open your web browser (or another TCP/IP application) to test your Internet connection.

## DHCP Configuration

After you set up a DHCP configuration, the DHCP server automatically provides your network information.

To set up a DHCP configuration:

- 1 In Network preferences, choose Built-in Ethernet from the Show pop-up menu.
- 2 Click TCP/IP, if necessary.
- 3 Choose Using DHCP from the Configure IPv4 pop-up menu.



- 4 Click Apply Now.

Open your web browser (or another TCP/IP application) to test your Internet connection.

**Note:** Unless your ISP instructs you to do otherwise, ignore the DHCP Client ID field and the Search Domains field.



## PPPoE Configuration

Some DSL-based ISPs use Point-to-Point Protocol over Ethernet (PPPoE). If you use a DSL modem and need a user name and password to connect to the Internet, check with your ISP to determine if you should connect using PPPoE.

### To set up a PPPoE connection:

Have your user name, password, and if required, the domain name server (DNS) address from your ISP available (see page 73).

- 1 In Network preferences, choose Built-in Ethernet from the Show pop-up menu.
- 2 Click PPPoE and select “Connect using PPPoE.”



- 3 Type the information into the corresponding fields. If you want all users of your computer to use the same connection method, select “Save password.”

**Note:** To connect automatically when you start a TCP/IP application, such as a web browser or email, click PPPoE Options, then select “Connect automatically when needed.”

- 4 Click TCP/IP and choose either Using PPP or Manually from the Configure IPv4 pop-up menu, as instructed by your ISP. If you have a static IP address from your ISP, choose Manually and type the address in the IP Address field.
- 5 Type the domain name server (DNS) addresses in the DNS Servers field.



- 6 Click Apply Now.

Once you configure your network, your Internet connection is ready. You can open your web browser or other TCP/IP application to test your connection.

**Important:** If you did not select the option to connect automatically, you will need to open the Internet Connect application, choose the correct configuration, and then click Connect. For more information, choose Help > Internet Connect Help from the menu bar at the top of the display.

## AirPort Extreme Wireless Connection

You can configure your AirPort Extreme network and Internet connection using AirPort Setup Assistant, located in the Utilities folder within your Applications folder. The assistant helps you configure the AirPort Extreme Base Station and set up your computer to use AirPort Extreme. For more information about your AirPort Extreme Base Station, see the *AirPort Extreme Base Station Setup Guide* that came with your base station.

If your AirPort Extreme Base Station is already configured, in most cases your AirPort Extreme Card is ready to access it immediately.

### To check if you have access to an AirPort Extreme network:

- Click the AirPort status icon in the menu bar and choose an AirPort network listed there.

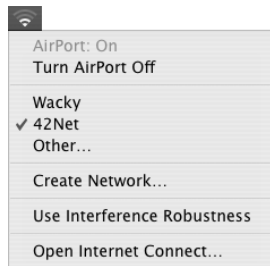

If you don't see an AirPort network listed, you can use AirPort Setup Assistant to check or change your settings, or you can change them using the Network pane of System Preferences.

## Setting Up an AirPort Extreme Connection Manually

Gather the following information from your system administrator if you'll be setting up a manual connection, which uses specific preassigned addresses for your servers and computer.

If you'll be connecting using DHCP, most of this information is provided to your computer automatically by the network, so ask your system administrator what is required.

- Domain name server (DNS) addresses, if necessary
- DHCP or manual IP address configuration
- IP address
- Router address
- Subnet mask
- Password, if required

Next, make sure your AirPort connection options are active in Network preferences.

**To set up Network preferences for an AirPort Extreme connection:**

- 1 Choose Apple () > System Preferences from the menu bar.
- 2 Click Network.
- 3 Choose Network Port Configurations from the Show pop-up menu.
- 4 Select the On checkbox next to AirPort.



Next, follow the instructions to configure your network either manually or using DHCP, as instructed by your ISP or network administrator. If you're setting up your network yourself, it may be easier to configure the network using DHCP, because the server assigns IP addresses automatically.

- 5 Choose AirPort from the Show pop-up menu.
- 6 Click TCP/IP, if necessary.
- 7 In the Configure IPv4 pop-up menu, choose either Manually or Using DHCP.



- If you chose Manually, type the other information into the corresponding fields.
  - If you chose Using DHCP, you don't need to enter any further information unless your system administrator has instructed you to do so.
- 8 Click AirPort and select options for joining an AirPort Extreme network after restarting or when your computer wakes from sleep.
  - 9 Click Apply Now.

Once you configure your AirPort settings, you are ready to connect.

**To test your AirPort Extreme connection:**

- Click the AirPort status icon in the menu bar and choose Turn AirPort On.  
Any AirPort Extreme network in range should appear in the menu.

## Troubleshooting Your Connection

### Cable Modem, DSL, and LAN Internet Connections

If you can't connect to the Internet using your cable modem, DSL, or local area network (LAN), see the following steps.

**Important:** Instructions that refer to modems do not apply to LAN users. LAN users may have hubs, switches, routers, or connection pods that cable and DSL modem users do not. LAN users should contact their network administrator rather than an ISP.

#### Check the cables and power supplies

Make sure all modem cables are firmly plugged in, including the modem power cord, the cable from the modem to the computer, and the cable from the modem to the wall jack. Check the cables and power supplies to Ethernet hubs and routers.

#### Turn the modem off and on and reset the modem hardware

Cycle the power on your DSL or cable modem by turning it off for a few minutes and then turning it back on. Some ISPs recommend that you unplug the modem's power cord. If your modem has a reset button, you can press it either before or after cycling the power.

### PPPoE Connections

If you are unable to connect to your ISP using PPPoE, first check the cables and power supplies, then turn the modem off and on again and reset the modem hardware.

#### Check System Preferences settings

- 1 Choose Apple () > System Preferences from the menu bar.
- 2 Click Network.
- 3 Choose Network Port Configurations from the Show pop-up menu.
- 4 Drag Built-in Ethernet to the top of the Port Configurations list.
- 5 Choose Built-in Ethernet from the Show pop-up menu.
- 6 Click PPPoE.
- 7 Select "Connect using PPPoE."
- 8 Check the Account Name field to be sure you have entered the correct information from your ISP.
- 9 If you chose to save your password, retype it to make sure it is correct.
- 10 Click TCP/IP. Make sure you've entered the correct information from your ISP in this pane.
- 11 Click Apply Now.

## Network Connections

If you have two or more computers attempting to share an Internet connection, be sure that your network is set up properly. You need to know if your ISP provides only one IP address or if it provides multiple IP addresses, one for each computer.

If only one IP address is used, then you must have a router capable of sharing the connection, also known as network address translation (NAT) or “IP masquerading.” For setup information, check the documentation provided with your router or ask the person who set up your network. The AirPort Extreme Base Station may be used to share one IP address among multiple computers. For information on using the AirPort Extreme Base Station, check the onscreen help or visit the Apple AirPort website at [www.apple.com/airport](http://www.apple.com/airport).

If you cannot resolve the issue using these steps, contact your ISP.





## Do you have a question? Here are the top ten questions commonly asked by new PowerBook users.

### **My Internet connection doesn't seem to be working. How do I set it up?**

There are different types of Internet connections. For example, you can connect via a modem, a DSL connection, a wireless AirPort connection, or an Ethernet network. You will need to supply Mac OS X with specific information about your connection type, Internet service provider, or network. The first step in configuring your connection is gathering the information needed for your connection type. To find out what information you need and for instructions on how to configure your connection type, see Appendix C, "Connecting to the Internet," on page 71. Your computer also has a Network Setup Assistant application to help walk you through setting up an Internet connection.

### **How do I set up my printer? Is it compatible with my PowerBook?**

Begin by connecting your printer and installing any software according to the instructions that came with your printer. Next, open System Preferences and click the Print & Fax icon. Use the Print & Fax pane to configure your PowerBook to access the printer. You'll find lots of information about setting up printers in Mac OS Help (search for "printer"). Also see "Connecting to a Printer" on page 25 of this manual.

If your printer doesn't seem to be working as expected, you may need to check the manufacturer's website for updated print drivers. Often the latest printer software is available for downloading.

If you sent a print job to your printer, but it's not printing, check to see if the print job is stopped or on hold by clicking the printer icon in the Dock. (If no icon appears in the Dock, open the Printer Setup Utility in the Applications/Utilities folder and double-click the printer's name.) If the window for the printer says "Job Stopped," click the Start Jobs button. If "Hold" appears beside the job name, resume printing by clicking the job name and clicking Resume. If a print job has stopped printing because of a technical error, you can delete the faulty job by selecting the job and clicking Delete. You can then try printing the job again.

### **How does the Mac OS X interface work?**

Users new to Mac OS X often have questions about how to carry out certain tasks. Your best source for Mac OS X information is Mac OS Help. You'll find introductory explanations for new users, users switching from Windows computers, and users upgrading from Mac OS 9. Open Mac OS Help by choosing Help > Mac Help from the Help menu in the Finder menu bar at the top of your screen, and browse the new user information listed there. Many of the basic tasks users are interested in involve the Finder, so try searching for "Finder," too.

### **How do I make my PowerBook battery last longer?**

You can conserve battery power by using the Energy Saver preference pane to specify how quickly the computer should go to sleep or dim the display. Open System Preferences and click the Energy Saver icon. Choose settings that are optimized for your type of usage. Using peripheral devices, such as hard disk drives, that get power from your computer can also shorten the amount of time your battery lasts. You can conserve battery power by disconnecting such devices. You can also purchase an additional battery that you can switch into your computer when power gets low. For more information about conserving battery power, see "Battery-Conservation Tips" on page 48.

### **I put a disc in my optical drive, but nothing happened. How do I know if the disc is compatible with my optical drive?**

Press the Media Eject (⏏) key to eject the disc. Apple slot-loading optical drives support only round 12 cm discs. Nonstandard discs with noncircular shapes do not work in the optical drive. For more information about nonstandard discs, check the AppleCare Knowledge Base at [www.apple.com/support](http://www.apple.com/support).

**Warning:** Inserting a nonstandard disc into the optical drive may damage the drive.

### **How do I connect a monitor or TV to my PowerBook?**

Your PowerBook comes with both a Mini-DVI to DVI Adapter and Mini-DVI to VGA Adapter, which allows you to connect to almost any projector, monitor, or flat-panel display. To connect to a television via composite or S-video, you can purchase the Mini-DVI to Video Adapter. To see the adapters included with your PowerBook, see page 5. For more information about connecting displays and other devices, see page 40.

### **I forgot my password. How do I reset it?**

You can reset your administrator password. See the instructions for resetting your password on page 59.

**I hear a fan coming on and my PowerBook seems to get quite warm.**

**Is that OK?**

As your PowerBook operates, it's designed to keep itself within safe thermal limits. The fan comes on and stays on to keep the PowerBook operating at normal temperatures. The bottom of your PowerBook may become warm because it's designed to let heat dissipate through the case. This is normal. For more information, see "Using Your PowerBook" on page 66.

**My application or Mac OS X doesn't seem to be working correctly.**

**Do I need to reinstall Mac OS X?**

The process of troubleshooting a problem requires that you determine a number of things, such as whether a problem always happens with a specific application, is related to your operating system, or is due to faulty hardware. Before you reinstall, see "Troubleshooting" on page 57 to help analyze the problem. Apple also provides many technical explanations and advice for solving problems in the AppleCare Knowledge Base. To access the Knowledge Base on the web, go to [www.apple.com/support](http://www.apple.com/support). If you determine that you must reinstall Mac OS X, you'll find instructions in "Restoring Your Computer's Software" on page 61.

**I installed an application on my PowerBook, but it doesn't seem to be working.**

**Where can I go for help?**

Check the documentation that came with the application or the manufacturer's website for instructions on how to get support. Often manufacturers are aware of common problems that might occur with their applications and provide solutions and updates for immediate use. If your program is not an Apple product, you'll need to contact the manufacturer directly for the best support.



## Communications Regulation Information

### FCC Compliance Statement

This device complies with part 15 of the FCC rules. Operation is subject to the following two conditions: (1) This device may not cause harmful interference, and (2) this device must accept any interference received, including interference that may cause undesired operation. See instructions if interference to radio or television reception is suspected.

### Radio and Television Interference

This computer equipment generates, uses, and can radiate radio-frequency energy. If it is not installed and used properly—that is, in strict accordance with Apple's instructions—it may cause interference with radio and television reception.

This equipment has been tested and found to comply with the limits for a Class B digital device in accordance with the specifications in Part 15 of FCC rules. These specifications are designed to provide reasonable protection against such interference in a residential installation. However, there is no guarantee that interference will not occur in a particular installation.

You can determine whether your computer system is causing interference by turning it off. If the interference stops, it was probably caused by the computer or one of the peripheral devices.

If your computer system does cause interference to radio or television reception, try to correct the interference by using one or more of the following measures:

- Turn the television or radio antenna until the interference stops.
- Move the computer to one side or the other of the television or radio.
- Move the computer farther away from the television or radio.
- Plug the computer into an outlet that is on a different circuit from the television or radio. (That is, make certain the computer and the television or radio are on circuits controlled by different circuit breakers or fuses.)

If necessary, consult an Apple-authorized service provider or Apple. See the service and support information that came with your Apple product. Or, consult an experienced radio/television technician for additional suggestions.

**Important:** Changes or modifications to this product not authorized by Apple Computer, Inc., could void the EMC compliance and negate your authority to operate the product.

This product was tested for EMC compliance under conditions that included the use of Apple peripheral devices and Apple shielded cables and connectors between system components. It is important that you use Apple peripheral devices and shielded cables and connectors between system components to reduce the possibility of causing interference to radios, television sets, and other electronic devices. You can obtain Apple peripheral devices and the proper shielded cables and connectors through an Apple-authorized dealer. For non-Apple peripheral devices, contact the manufacturer or dealer for assistance.

*Responsible party (contact for FCC matters only):* Apple Computer, Inc. Product Compliance, 1 Infinite Loop M/S 26-A, Cupertino, CA 95014-2084, 408-974-2000.

### Industry Canada Statement

Complies with the Canadian ICES-003 Class B specifications. Cet appareil numérique de la classe B est conforme à la norme NMB-003 du Canada.

### VCCI Class B Statement

情報処理装置等電波障害自主規制について

この装置は、情報処理装置等電波障害自主規制協議会 (VCCI) の基準に基づくクラス B 情報技術装置です。この装置は家庭環境で使用されることを目的としていますが、この装置がラジオやテレビジョン受信機に近接して使用されると、受信障害を引き起こすことがあります。

取扱説明書に従って正しい取扱をしてください。

### European Community

Complies with European Directives 72/23/EEC, 89/336/EEC, and 99/5/EEC.

## Laser Information

Making adjustments or performing procedures other than those specified in your equipment's manual may result in hazardous radiation exposure.

Do not attempt to disassemble the cabinet containing the laser. The laser beam used in this product is harmful to the eyes. The use of optical instruments, such as magnifying lenses, with this product increases the potential hazard to your eyes. For your safety, have this equipment serviced only by an Apple-authorized service provider.

If you have an internal Apple CD-ROM, DVD-ROM, or DVD-RAM drive in your computer, your computer is a Class 1 laser product. The Class 1 label, located in a user-accessible area, indicates that the drive meets minimum safety requirements. A service warning label is located in a service-accessible area. The labels on your product may differ slightly from the ones shown here.



Class 1 label

Service warning label

## Exposure to Radio Frequency Energy

The radiated output power of the optional AirPort Extreme Card is far below the FCC radio frequency exposure limits. Nevertheless, it is advised to use the wireless equipment in such a manner that the potential for human contact during normal operation is minimized.

## Mouse and Keyboard Information

The Apple optical mouse is a Class 1 LED product. This product complies with the requirements of European Directives 72/23/EEC and 89/336/EEC.

It also complies with the Canadian ICES-003 Class B Specification.

## High-Risk Activities Warning

This computer system is not intended for use in the operation of nuclear facilities, aircraft navigation or communications systems, or air traffic control machines, or for any other uses where the failure of the computer system could lead to death, personal injury or severe environmental damage.

## ENERGY STAR® Compliance

As an ENERGY STAR® partner, Apple has determined that standard configurations of this product meet the ENERGY STAR® guidelines for energy efficiency. The ENERGY STAR® program is a partnership with office product equipment manufacturers to promote energy-efficiency. Reducing energy consumption of office products saves money and reduces pollution by eliminating wasted energy.

## Battery Disposal Information

Dispose of batteries according to your local environmental laws and guidelines.

Nederlands: Gebruikte batterijen kunnen worden ingeleverd bij de chemokar of in een speciale batterijcontainer voor klein chemisch afval (kca) worden gedeponneerd.

## Telephone and Apple 56K Modem Information

### Notify Your Telephone Company

Some telephone companies require that you notify the local business office when you hook up a modem to their lines.

### Information You Need in the United States

The internal modem complies with Part 6B of the FCC rules. On the back of this equipment is a label that contains, among other information, the FCC registration number and ringer equivalence number (REN). If requested, provide this information to your telephone company.

- **Ringer equivalence number (REN):** 0.1B The REN is useful to determine the quantity of devices you may connect to your telephone lines and still have all those devices ring when your telephone number is called. In most, but not all areas, the sum of the RENs of all devices connected to one line should not exceed five (5.0). To be certain of the number of devices you may connect to your line, as determined by the REN, you should contact your local telephone company to determine the maximum REN for your calling area.
- **Telephone jack type:** USOC, RJ-11 An FCC-compliant telephone cord and modular plug are provided with this equipment. This equipment is designed to be connected to the telephone network or premises wiring using a compatible modular jack that complies with Part 68 rules. See the installation instructions for details.

### Telephone Line Problems

If your telephone doesn't work, there may be a problem with your telephone line. Disconnect the modem to see if the problem goes away. If it doesn't, report the problem either to your local telephone company or to your company's telecommunications people.

If disconnecting the modem eliminates the problem, the modem itself may need service. See the service and support information that came with your Apple product for instructions on how to contact Apple or an Apple-authorized service provider for assistance.

If you do not disconnect your modem when it is adversely affecting the telephone line, the telephone company has the right to disconnect your service temporarily until you correct the problem. The telephone company will notify you as soon as possible. Also, you will be informed of your right to file a complaint with the FCC.

The telephone company may make changes in its facilities, equipment, operations, or procedures that could affect the operation of your equipment. If this happens, the telephone company will provide advance notice in order for you to make the necessary modifications to maintain uninterrupted service.

The internal modem will not work with party lines, cannot be connected to a coin-operated telephone, and may not work with a private branch exchange (PBX).

### Telephone Consumer Protection Act

The Telephone Consumer Protection Act of 1991 makes it unlawful for any person to use a computer or other electronic device to send any message via a telephone fax machine unless such message clearly contains, in a margin at the top or bottom of each transmitted page or on the first page of the transmission, the date and time it was sent and an identification of the business or other entity, or individual sending the message and the telephone number of the sending machine of such business, entity, or individual.

### Information You Need in Canada

The Industry Canada (IC) label identifies certified equipment. This certification means that the equipment meets certain telecommunications network protective, operational, and safety requirements. The Department does not guarantee the equipment will operate to a user's satisfaction.

Before installing this equipment, make sure that you are permitted to connect to the facilities of the local telecommunications company. Be sure you use an acceptable method of connection to install the equipment. In some cases, you may extend the company's internal wiring for single-line individual service by means of a certified telephone extension cord. Be aware, however, that compliance with these conditions may not prevent degradation of service in some situations.

Repairs to certified equipment should be made by an authorized Canadian maintenance facility designated by the supplier. Any equipment malfunctions or repairs or alterations that you make to this equipment may cause the telecommunications company to request that you disconnect the equipment.

*In Canada, contact Apple at: 7495 Birchmount Road, Markham, Ontario, L3R 5G2, 800-263-3394*

Warning: Users should ensure for their own protection that the electrical ground connections of the power utility, telephone lines, and internal metallic water pipe system, if present, are connected together. This precaution may be particularly important in rural areas.

Users should not attempt to make such connections themselves, but should contact the appropriate electric inspection authority or electrician.

- *Load number:* 0.1 The load number (LN) assigned to each terminal device denotes the percentage of the total load to be connected to the telephone loop that is used by the device, to prevent overloading. The termination of a loop may consist of any combination of devices, subject only to the requirement that the sum of the load numbers of all devices does not exceed 100.
- *Telephone jack type:* CA-11

### Informations Destinées aux Utilisateurs Canadiens

L'étiquette d'Industrie Canada identifie un matériel homologué. Cette étiquette certifie que le matériel est conforme à certaines normes de protection, d'exploitation et de sécurité des réseaux de télécommunications. Le Ministère n'assure toutefois pas que le matériel fonctionnera à la satisfaction de l'utilisateur.

Avant d'installer ce matériel, l'utilisateur doit s'assurer qu'il est permis de le raccorder au réseau de l'entreprise locale de télécommunication. Le matériel doit également être installé en suivant une méthode acceptée de raccordement. Dans certains cas, le câblage appartenant à l'entreprise utilisé pour un service individuel à ligne unique peut être prolongé au moyen d'un dispositif homologué de raccordement (cordon prolongateur téléphonique).

L'abonné ne doit pas oublier qu'il est possible que la conformité aux conditions énoncées ci-dessus n'empêche pas la dégradation du service dans certaines situations. De fait, les entreprises de télécommunication ne permettent pas que l'on raccorde un matériel aux prises d'abonnés, sauf dans les cas précis prévus par les tarifs particuliers de ces entreprises.

Les réparations de matériel homologué doivent être effectuées par un centre d'entretien canadien autorisé désigné par la fournisseur. La compagnie de télécommunications peut demander à l'utilisateur de débrancher un appareil suite à des réparations ou à des modifications effectuées par l'utilisateur ou en raison d'un mauvais fonctionnement.

Veuillez contacter Apple pour des informations supplémentaires:

Apple Canada, Inc.  
7495 Birchmount Road  
Markham, Ontario  
Canada L3R 5G2

Service à la clientèle d'Apple Canada: 800-263-3394

Avertissement : Pour sa propre protection, l'utilisateur doit s'assurer que tout les fils de mise à la terre du secteur, des lignes téléphoniques et les canalisations d'eau métalliques, s'il y en a, soient raccordés ensemble. Cette précaution est particulièrement importante dans les régions rurales.

L'utilisateur ne doit pas tenter de faire ces raccordements lui-même; il doit avoir recours à un service d'inspection des installations électriques ou à un électricien, selon le cas.

- *Numéro de charge:* 0.1 L'indice de charge (IC) assigné à chaque dispositif terminal indique, pour éviter toute surcharge, le pourcentage de la charge totale qui sera raccordée à un circuit téléphonique bouclé utilisé par ce dispositif. La terminaison du circuit bouclé peut être constituée de n'importe quelle combinaison de dispositifs pourvu que la somme des indices de charge de l'ensemble des dispositifs ne dépasse pas 100.
- *Type de prise téléphonique:* CA-11

### Information You Need in the United Kingdom

This terminal equipment is intended for direct connection to the analogue Public Switched Telecommunications Network and is approved for use within the United Kingdom with the following features:

- Modem facility
- Autocalling facility
- Autoanswer facility
- DTMF signaling

Operation in the absence of proceed indication or upon detection of proceed indication

This product is in conformity with relevant regulatory standards following the provisions of European Council Directives 73/23/EEC (Low Voltage Directive) and 89/336/EEC amended by 92/31/EEC (EMC Directive).

### Informationen für Deutschland

Diese Modem-Karte ist als Endeinrichtung vorgesehen und muss an ein TAE mit F-Kodierung angeschlossen werden. Diese Endeinrichtung ist in Konformität gemäß Niederspannungsrichtlinie 73 / 23 / EWG sowie EMC-Richtlinien 89 / 336 / EWG und 92 / 31 / EWG.

### Informations pour la France

Ce matériel est conforme aux normes applicables de sécurité électrique d'après la directive 73 / 23 / CEE et aux normes applicables de compatibilité électromagnétique d'après la directive 89 / 336 / CEE, modifiée par la directive 92 / 31 / CEE.



### Information You Need in Australia

All telecommunications devices are required to be labelled as complying to the Australian telecommunications standards, ensuring the health and safety of the operator and the integrity of the Australian telecommunications network. To provide compliance with the Australian Communications Authority's technical standards, please ensure that the following AT commands are maintained:

- ATB0 (ITU/CCITT operation)
- AT&G0 (no guard tone)
- AT&P1 (33/66 pulse dial make/break ratio)
- ATS0 = 0 or ATS0 = 1 (no answer or answer greater than one ring)
- ATS6 = 95 (DTMF period between 70–255 ms)
- ATS11 = 95 (DTMF period between 70–255 ms)

For calls that are automatically generated, a total of three call attempts are allowed to a telephone number, with a minimum period between calls of 2 seconds. If the call does not connect after three attempts, 30 minutes must expire before automatic redialing may be initiated. Failure to set the modem (and any associated communications software) to the above settings may result in the modem being non-compliant with Australian telecommunications standards. Under these circumstances a user could be subject to significant penalties under the Telecommunications Act 1997.

This modem must be properly secured in order for you to use it. Telecommunications network voltages exist inside the computer and the telecommunications line connection must be removed before opening the computer.

### Information You Need in New Zealand

This modem is fully approved to operate on the New Zealand telecommunications network under Telepermit number PTC 211/04/002. All telecommunications devices are required to hold a Telepermit and be labelled accordingly with the approved Telepermit number to comply with the New Zealand telecommunications standards, ensuring the health and safety of the operator and the integrity of the New Zealand telecommunications network. To ensure compliance, all calls that are automatically generated should not make more than 10 call attempts to the same number within any 30 minute period with a minimum period between calls of 30 seconds. Failure to adhere to these standards may result in the modem being non-compliant with New Zealand Telecom standards. Under these circumstances a user could be subject to significant penalties.

**Important:** The grant of a Telepermit for any item of terminal equipment indicates that only Telecom has accepted that the item complies with minimum conditions for connection to its network. It indicates no endorsement of the product by Telecom, nor does it provide any sort of warranty. Above all, it provides no assurance that any item will work correctly in all respects with another item of Telepermitted equipment of a different make or model, nor does it imply that any product is compatible with all of Telecom's network services.



## A

- AC cord 21
- AC plug 10, 21
- adjusting your display 20
- AirPort Extreme
  - antenna window 7
  - base station 37
  - Card 37
  - connection 74
  - problems 60
  - setting up 83
  - setting up a connection 11, 73
- amber light 21
- analog phone line 13, 39
- Apple 56K internal modem 39
- application freeze 29
- audio line in port 9

## B

- base station 37
- battery 17, 46, 47
  - calibrating 17
  - charging 48
  - conservation 48
  - conserving power 90
  - disposal 47, 94
  - flashing lights 46
  - indicator lights 46
  - power 48
  - tips 48
- blinking question mark 14
- Bluetooth technology 36
- brightness controls 7
- built-in speakers 7, 39
- burning DVDs 45

## C

- cable modem 77
  - setting up 11, 73
- calibrating your battery 17
- carrying your PowerBook 65
- CDs 43

- changing
  - image size 20
  - password 59
  - System Preferences 24
  - the desktop 24
  - the resolution 20
  - the screen 20
- charging the battery 48
- checking memory 55
- cleaning
  - your display 65
  - your PowerBook 65
- closed display 42
- communicating via Bluetooth 36
- computer
  - freezes 58
  - inventory 5
  - won't turn on 59
- connecting
  - a cable modem 13
  - a DSL modem 13
  - a monitor or TV 90
  - an external monitor 40, 41
  - a printer 25
  - a TV 42
  - a video device 42
  - Bluetooth devices 36
  - external devices 32
  - FireWire devices 34
  - FireWire hard disk drives 34
  - headphones 26
  - mobile phone 36
  - modem 39
  - PDA via Bluetooth 36
  - projector 41
  - to an Ethernet network 13
  - two computers 34, 35
  - USB printers 32
  - VCR 42
  - videocameras 34
  - wirelessly 37
- conserving battery power 90

## controls

- brightness 7
- volume 7

## D

- default resolution 20
- DHCP 74
  - configuration 80
- dial-up
  - connection 75
  - modem 74
- dialup connection 71
- discs
  - compatible 90
- display
  - cleaning 65
  - default resolution 20
  - goes black 59
  - mirroring 40
  - release button 7
- disposing of batteries 47, 94
- downloading software 27
- DSL 74, 77
  - modem 11, 73
- dual-display mode 40
- DVD
  - burning 45
  - discs 44
- DVI adapter 40
- DVI connector 40
- Dynamic Host Configuration Protocol (DHCP) 77

## E

- ejecting a disc 44
- ergonomics 69
- Ethernet
  - cables 38
  - networking capability 38
  - port 9, 38
- external
  - microphones 39
  - monitor 40, 41
- external monitor port 9

## F

- fan noise 91
- finding your serial number 62
- FireWire
  - cable 34, 35
  - devices and battery power 35
  - port 9, 34
- FireWire Target Disk Mode 34, 35
- Force Quit 29
- frozen application 29
- function key 7

## G

- general safety 67
- green light 21

## H

- hand positions 69
- headphone
  - jack 39
  - port 9, 39

## I

- image size 20
- inserting a disc 43
- installation instructions 5
- installing
  - memory 52
- internal modem 39
- Internet
  - configuration 76
  - connection 61, 89
  - using Setup Assistant 83
- Internet service provider 72
- inventory of items 5
- ISP 72

## K

- keeping the display closed 42

## L

- LAN 77
  - connection 11, 73, 74
- locating your serial number 62

## M

- Mac OS 9 24
- Mac OS X 24
  - interface 90
- manual Internet configuration 79
- manually using DHCP router option 11, 73
- Media Eject key 7
- memory
  - checking 55
- microphone 7, 39
- mini-DVI port 9
- Mini-DVI to DVI Adapter 40
- Mini-DVI to VGA adapter 40
- Mini-DVI to Video Adapter 40
- modem 12, 39
  - cable 71
  - DSL 71
- monitoring a printer 25
- mouse 23
- multiple USB devices 33

## N

- Network Connections 87
- networking
  - two computers 34, 35
  - wireless 37
- Network Setup Assistant 71, 89
- numeric keypad 23
- Num Lock key 7

## O

- optical drive 43
  - compatible discs 90
  - disc sizes supported 43

## P

- password 90
  - resetting 90
- playing
  - a video 44
  - CDs 43
  - DVD-Video discs 44
- plug
  - AC 10
- Point-to-Point Protocol 74, 77, 81
- port
  - audio line in 9
  - Ethernet 9
  - external monitor 9
  - FireWire 9
  - headphone 9, 39
  - mini-DVI 9
  - power adapter 9
  - USB 9
- power adapter 21, 66
  - port 9
- Power button 7, 14
- PPPoE 74
  - configuration 81
  - connections 12, 74, 86
- presentation mode (see display mirroring) 40
- Print & Fax preferences 25
- printing 25
  - setup 25
- problems
  - computer freezes 58
  - computer won't respond 58
  - computer won't turn on 59
  - display goes black 59
  - Internet connection 61, 86
  - pointer won't move 58
  - PPPoE connections 86
  - restoring your software 61
  - trouble ejecting a disc 60
  - trouble using AirPort 60
  - turning the computer on 14

- with an application 59
- Putting your PowerBook to sleep 16

## R

- RAM
  - checking 55
  - installing 52
- recording
  - CD-R 45
  - CD-RW 45
  - DVD 45
  - music 45
- reinstalling software 61, 91
- removing the battery 47
- replacing the battery 47
- resetting your password 59
- restoring software 61
- RJ-11 cable 39

## S

- safety 67
    - power adapter 66
    - using your PowerBook 66
  - SDRAM specifications 51
  - security slot 9, 49
  - serial number 62
  - setting up 11, 73
    - my printer 89
    - to connect manually 74
  - setting up a printer 25
  - Setup Assistant 11
  - shutting down 17
  - sleep 16
    - indicator light 7
  - software installer 61
  - Software Update 27
  - speakers 7, 39
  - specifications
    - SDRAM 51
  - static IP address 79
  - stopping
    - an application 29
    - the computer 17
  - storing your PowerBook 65
  - SuperDrive 7, 43
  - System Preferences 24
- ## T
- telephone dial-up connection 11, 73
  - testing your Internet configuration 76
  - trackpad 7, 15, 22
    - tips 22
  - transferring
    - files or documents 28
    - information 34, 35

- trouble ejecting a disc 60
- troubleshooting
  - AirPort 60
  - an application 59
  - computer freezes 58
  - computer won't respond 58
  - computer won't turn on 59
  - display goes black 59
  - ejecting a disc 60
  - Internet connection 61
  - pointer won't move 58
  - turning the computer on 14
  - your connection 86
- typing position 69

## U

- Universal Serial Bus (USB) 32
- updating software 27
- USB
  - devices and battery power 32
  - hubs 33
  - multiple devices 33
  - ports 9, 32

- using
  - AirPort 37
  - Bluetooth devices 36
  - FireWire devices 34
  - multiple USB devices 33
  - your optical drive 43
  - using DHCP option 12, 73

## V

- VGA adapter 40
- VGA connection 41
- video
  - playing 44
- video-mirroring 40
- Video Mode Toggle key 7
- volume controls 7

## W

- waking your computer 16
- wireless connections 37
- working with a printer 25



