

GIGABYTE™

G492-PD0

ARM HPC Server - Ampere® Altra® ARM Server

User Manual

Rev. 1.0

Copyright

© 2022 GIGA-BYTE TECHNOLOGY CO., LTD. All rights reserved.

The trademarks mentioned in this manual are legally registered to their respective owners.

Disclaimer

Information in this manual is protected by copyright laws and is the property of GIGABYTE. Changes to the specifications and features in this manual may be made by GIGABYTE without prior notice. No part of this manual may be reproduced, copied, translated, transmitted, or published in any form or by any means without GIGABYTE's prior written permission.

Documentation Classifications

In order to assist in the use of this product, GIGABYTE provides the following types of documentation:

- User Manual: detailed information & steps about the installation, configuration and use of this product (e.g. motherboard, server barebones), covering hardware and BIOS.
- User Guide: detailed information about the installation & use of an add-on hardware or software component (e.g. BMC firmware, rail-kit) compatible with this product.
- Quick Installation Guide: a short guide with visual diagrams that you can reference easily for installation purposes of this product (e.g. motherboard, server barebones).

Please see the support section of the online product page to check the current availability of these documents.

For More Information

For related product specifications, the latest firmware and software, and other information please visit our website at <http://www.gigabyte.com>

For GIGABYTE distributors and resellers, additional sales & marketing materials are available from our reseller portal: <http://reseller.b2b.gigabyte.com>

For further technical assistance, please contact your GIGABYTE representative or visit <https://esupport.gigabyte.com/> to create a new support ticket

For any general sales or marketing enquiries, you may also message GIGABYTE server directly by email: server.grp@gigabyte.com

Conventions

The following conventions are used in this user's guide:

	NOTE! Gives bits and pieces of additional information related to the current topic.
	CAUTION! Gives precautionary measures to avoid possible hardware or software problems.
	WARNING! Alerts you to any damage that might result from doing or not doing specific actions.

Server Warnings and Cautions

Before installing a server, be sure that you understand the following warnings and cautions.



WARNING!

To reduce the risk of electric shock or damage to the equipment:

- Do not disable the power cord grounding plug. The grounding plug is an important safety feature.
- Plug the power cord into a grounded (earthed) electrical outlet that is easily accessible at all times.
- Unplug all the power cords from the power supplies to disconnect power to the equipment.



- Shock Hazard! Disconnect all power supply cords before servicing.
- Do not route the power cord where it can be walked on or pinched by items placed against it. Pay particular attention to the plug, electrical outlet, and the point where the cord extends from the server.



WARNING!

To reduce the risk of personal injury from hot surfaces, allow the drives and the internal system components to cool before touching them.



WARNING!

This server is equipped with high speed fans. Keep away from hazardous moving fan blades during servicing.



WARNING!

This equipment is intended to be used in Restrict Access Location. The access can only be gained by Skilled person.

Only authorized by well trained professional person can access the restrict access location.



CAUTION!

- Do not operate the server for long periods with the access panel open or removed. Operating the server in this manner results in improper airflow and improper cooling that can lead to thermal damage.
- Danger of explosion if battery is incorrectly replaced.
- Replace only with the same or equivalent type recommended by the manufacturer.
- Dispose of used batteries according to the manufacturer's instructions.

Electrostatic Discharge (ESD)



CAUTION!

ESD CAN DAMAGE DRIVES, BOARDS, AND OTHER PARTS. WE RECOMMEND THAT YOU PERFORM ALL PROCEDURES AT AN ESD WORKSTATION. IF ONE IS NOT AVAILABLE, PROVIDE SOME ESD PROTECTION BY WEARING AN ANTI-STATIC WRIST STRAP ATTACHED TO CHASSIS GROUND -- ANY UNPAINTED METAL SURFACE -- ON YOUR SERVER WHEN HANDLING PARTS.

Always handle boards carefully. They can be extremely sensitive to ESD. Hold boards only by their edges without any component and pin touching. After removing a board from its protective wrapper or from the system, place the board component side up on a grounded, static free surface. Use a conductive foam pad if available but not the board wrapper. Do not slide board over any surface.

System power on/off: To remove power from system, you must remove the system from rack. Make sure the system is removed from the rack before opening the chassis, adding, or removing any non hot-plug components.

Hazardous conditions, devices and cables: Hazardous electrical conditions may be present on power, telephone, and communication cables. Turn off the system and disconnect the cables attached to the system before servicing it. Otherwise, personal injury or equipment damage can result.

Electrostatic discharge (ESD) and ESD protection: ESD can damage drives, boards, and other parts. We recommend that you perform all procedures in this chapter only at an ESD workstation. If one is not available, provide some ESD protection by wearing an antistatic wrist strap attached to chassis ground (any unpainted metal surface on the server) when handling parts.

ESD and handling boards: Always handle boards carefully. They can be extremely sensitive to electrostatic discharge (ESD). Hold boards only by their edges. After removing a board from its protective wrapper or from the system, place the board component side up on a grounded, static free surface. Use a conductive foam pad if available but not the board wrapper. Do not slide board over any surface.

Installing or removing jumpers: A jumper is a small plastic encased conductor that slips over two jumper pins. Some jumpers have a small tab on top that can be gripped with fingertips or with a pair of fine needle nosed pliers. If the jumpers do not have such a tab, take care when using needle nosed pliers to remove or install a jumper; grip the narrow sides of the jumper with the pliers, never the wide sides. Gripping the wide sides can damage the contacts inside the jumper, causing intermittent problems with the function controlled by that jumper. Take care to grip with, but not squeeze, the pliers or other tool used to remove a jumper, or the pins on the board may bend or break.

**CAUTION!**

Risk of explosion if battery is replaced incorrectly or with an incorrect type. Replace the battery only with the same or equivalent type recommended by the manufacturer. Dispose of used batteries according to the manufacturer's instructions.

Table of Contents

Chapter 1	Hardware Installation	10
1-1	Installation Precautions	10
1-2	Product Specifications	11
1-3	System Block Diagram	14
Chapter 2	System Appearance	15
2-1	Front View	15
2-2	Rear View	16
2-3	Front Panel LED and Buttons	17
2-4	Front Panel System LAN LEDs	18
2-5	Power Supply Unit (PSU) LED	19
2-6	Hard Disk Drive LEDs	20
Chapter 3	System Hardware Installation	21
3-1	Removing and Installing the Chassis Top Cover	22
3-2	Removing and Installing the HGX Tray	23
3-3	Removing and installing the Heat Sink	24
3-4	Installing the CPU	25
3-5	Installing the Memory	26
3-5-1	Eight Channel Memory Configuration	26
3-5-2	Installing the Memory	27
3-5-3	DIMM Population Table	27
3-5-4	Altra Platform DDR4 Suggest Configuration Table	28
3-6	Installing the PCI Expansion Card	29
3-7	Installing the Hard Disk Drive	30
3-8	Installing the M.2 Device and Heat Sink	31
3-9	Replacing the System Fan Module	32
3-10	Removing and Installing the Power Supply	33
3-11	Cable Connection	34
3-11-1	Motherboard to PCIe Board and Front IO Board	34
3-11-2	Motherboard to PCIe Board and HDD Back Plane Board	36
Chapter 4	Motherboard Components	38
4-1	Motherboard Components	38
4-2	Jumper Setting	40
4-3	Backplane Board Storage Connector	41

4-3-1	CBPG060	41
Chapter 5	BIOS Setup	42
5-1	The Main Menu	44
5-2	Advanced Menu	47
5-2-1	Trusted Computing	48
5-2-2	ACPI Settings	49
5-2-3	General Watchdog Timer	50
5-2-4	APEI Configuration	51
5-2-5	X86 Emulation Configuration	52
5-2-6	PCI Subsystem Settings	53
5-2-7	Info Report Configuration	59
5-2-8	USB Configuration	60
5-2-9	Network Stack Configuration	61
5-2-10	IP Configuration	62
5-2-11	NVMe Configuration	63
5-2-12	Graphic Output Configuration	64
5-2-13	Power Restore Configuration	65
5-2-14	Tls Auth Configuration	66
5-2-15	Intel(R) I350 Gigabit Network Connection	67
5-2-16	Mellanox Network Adapter	69
5-2-17	MAC IPv6 Network Configuration	71
5-2-18	MAC IPv4 Network Configuration	72
5-3	Chipset Setup Menu	73
5-3-1	CPU Configuration	74
5-3-2	Memory Slot Information	75
5-3-3	RAS Configuration	77
5-3-4	Serialport console	78
5-3-5	PCIe Root Complex Configuration	79
5-4	Server Management Menu	80
5-4-1	System Event Log	81
5-4-2	Bmc self test log	82
5-4-3	View FRU Information	83
5-4-4	BMC Network Configuration	84
5-5	Security Menu	85
5-5-1	Secure Boot	86
5-6	Boot Menu	89
5-7	Save & Exit Menu	91
5-8	BIOS POST Beep code (AMI standard)	93
5-8-1	PEI Beep Codes	93

5-8-2 DXE Beep Codes93

Chapter 1 Hardware Installation

1-1 Installation Precautions

The motherboard/system contain numerous delicate electronic circuits and components which can become damaged as a result of electrostatic discharge (ESD). Prior to installation, carefully read the user manual and follow these procedures:

- Prior to installation, do not remove or break motherboard S/N (Serial Number) sticker or warranty sticker provided by your dealer. These stickers are required for warranty validation.
- Always remove the AC power by unplugging the power cord from the power outlet before installing or removing the motherboard or other hardware components.
- When connecting hardware components to the internal connectors on the motherboard, make sure they are connected tightly and securely.
- When handling the motherboard, avoid touching any metal leads or connectors.
- It is best to wear an electrostatic discharge (ESD) wrist strap when handling electronic components such as a motherboard, CPU or memory. If you do not have an ESD wrist strap, keep your hands dry and first touch a metal object to eliminate static electricity.
- Prior to installing the motherboard, please have it on top of an antistatic pad or within an electrostatic shielding container.
- Before unplugging the power supply cable from the motherboard, make sure the power supply has been turned off.
- Before turning on the power, make sure the power supply voltage has been set according to the local voltage standard.
- Before using the product, please verify that all cables and power connectors of your hardware components are connected.
- To prevent damage to the motherboard, do not allow screws to come in contact with the motherboard circuit or its components.
- Make sure there are no leftover screws or metal components placed on the motherboard or within the computer casing.
- Do not place the computer system on an uneven surface.
- Do not place the computer system in a high-temperature environment.
- Turning on the computer power during the installation process can lead to damage to system components as well as physical harm to the user.
- If you are uncertain about any installation steps or have a problem related to the use of the product, please consult a certified computer technician.







1-2 Product Specifications



NOTE:

We reserve the right to make any changes to the product specifications and product-related information without prior notice.

	System Dimension	<ul style="list-style-type: none"> ◆ 4U ◆ 448 x 175.2 x 900 (W x H x D, mm)
	CPU	<ul style="list-style-type: none"> ◆ Ampere® Altra® Processor ◆ Single processor, 7nm technology ◆ Up to 80-core per processor
	Chipset	<ul style="list-style-type: none"> ◆ System on Chip
	Memory	<ul style="list-style-type: none"> ◆ 16 x DIMM slots ◆ DDR4 memory supported only ◆ 8-channel memory architecture per processor ◆ RDIMM modules up to 256GB supported ◆ LRDIMM modules up to 256GB supported ◆ Up to 4TB of memory capacity supported per processor ◆ Memory speed: Up to 3200 MHz <p style="color: blue; margin-top: 5px;">Note: Only supports configurations with 1, 2, 4, 6, 8, 12, or 16 DIMMs</p>
	LAN	<ul style="list-style-type: none"> ◆ 2 x 1GbE LAN ports (1 x Intel® I350-AM2) ◆ 1 x 10/100/1000 management LAN
	Video	<ul style="list-style-type: none"> ◆ Integrated in Aspeed® AST2500 ◆ 2D Video Graphic Adapter with PCIe bus interface ◆ 1920x1200@60Hz 32bpp, DDR4 SDRAM
	Storage	<ul style="list-style-type: none"> ◆ 6 x 2.5" Gen4 U.2 NVMe hot-swappable HDD/SSD bays
	RAID	<ul style="list-style-type: none"> ◆ N/A
	Expansion Slot	<ul style="list-style-type: none"> ◆ 8 x SXM4 sockets for NVIDIA HGX™ A100 8-GPU 40GB/80GB module ◆ 10 x Low profile Gen4 x16 expansion slots <ul style="list-style-type: none"> - 8 x expansion slots in rear side, 2 x expansion slots in front side ◆ Onboard <ul style="list-style-type: none"> • 2 x M.2 slots: <ul style="list-style-type: none"> - M-key - PCIe Gen4 x4 - Supports 2242/2260/2280/22110 cards ◆ M.2 extension board: CMTPO63 <ul style="list-style-type: none"> • 2 x M.2 slots: <ul style="list-style-type: none"> - M-key - PCIe Gen4 x4 - Supports NGFF-2280/22110 cards

	Internal I/O	<ul style="list-style-type: none"> ◆ 1 x TPM header ◆ 1 x Front panel header
	Front I/O	<ul style="list-style-type: none"> ◆ 2 x USB 3.0 ◆ 1 x VGA ◆ 2 x RJ45 ◆ 1 x MLAN ◆ 1 x Power button with LED ◆ 1 x ID button with LED ◆ 1 x Reset button ◆ 1 x System status LED ◆ 1 x HDD access LED
	Rear I/O	<ul style="list-style-type: none"> ◆ N/A
	Backplane I/O	<ul style="list-style-type: none"> ◆ 6 x 2.5" NVMe ports ◆ Speed and bandwidth: PCIe Gen4 x4
	TPM	<ul style="list-style-type: none"> ◆ 1 x TPM header with SPI interface ◆ Optional TPM2.0 kit: CTM010
	Power Supply	<ul style="list-style-type: none"> ◆ 3+1 x 3000W redundant PSUs ◆ 80 PLUS Platinum ◆ AC Input: <ul style="list-style-type: none"> - 115-127V~/ 14.2A, 50-60Hz - 200-240V~/ 15.8A, 50-60Hz ◆ DC Input: <ul style="list-style-type: none"> 240Vdc/ 14A ◆ DC Output: <ul style="list-style-type: none"> - Max 1200W/ 100-127V~ +54V/ 95.6A +12Vsb/ 3.5A - Max 3000W/ 200-240V~ +54V/ 178.1A +12Vsb/ 3.5A
<p>NOTE: The system power supply requires C19 type power cord</p>		



System Management

Aspeed® AST2500 management controller
GIGABYTE Management Console (AMI MegaRAC SP-X) web interface

- ◆ Dashboard
- ◆ HTML5 KVM
- ◆ Sensor Monitor (Voltage, RPM, Temperature, CPU Status ...etc.)
- ◆ Sensor Reading History Data
- ◆ FRU Information
- ◆ SEL Log in Linear Storage / Circular Storage Policy
- ◆ Hardware Inventory
- ◆ Fan Profile
- ◆ System Firewall
- ◆ Power Consumption
- ◆ Power Control
- ◆ LDAP / AD / RADIUS Support
- ◆ Backup & Restore Configuration
- ◆ Remote BIOS/BMC/CPLD Update
- ◆ Event Log Filter
- ◆ User Management
- ◆ Media Redirection Settings
- ◆ PAM Order Settings
- ◆ SSL Settings
- ◆ SMTP Settings



Operating Properties

- ◆ Operating temperature: 10°C to 35°C
- ◆ Operating humidity: 8-80% (non-condensing)
- ◆ Non-operating temperature: -40°C to 60°C
- ◆ Non-operating humidity: 20%-95% (non-condensing)

1-3 System Block Diagram

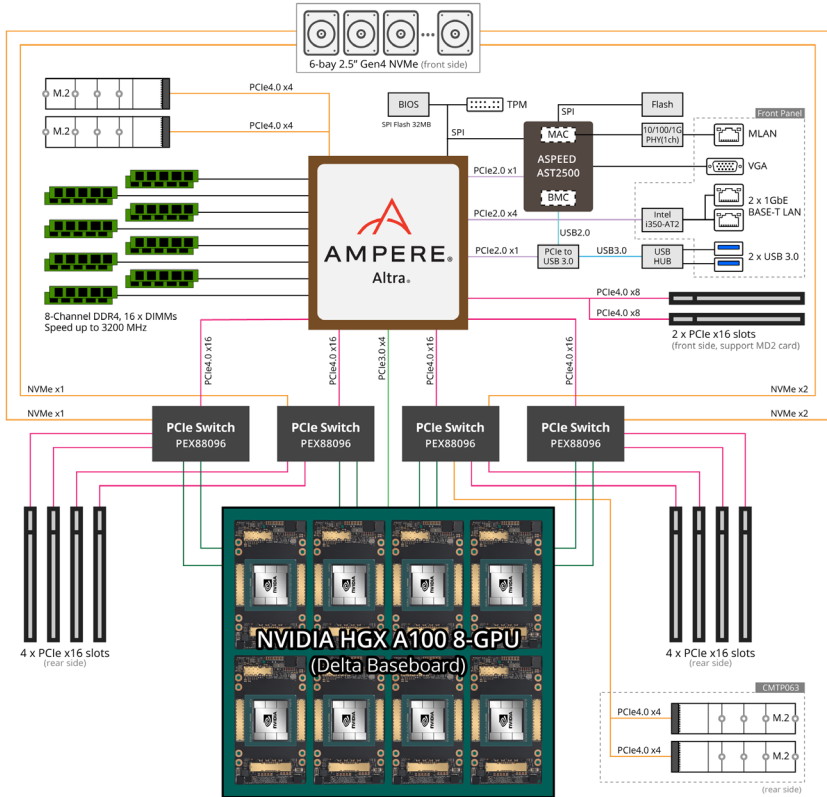

Chapter 2 System Appearance

2-1 Front View

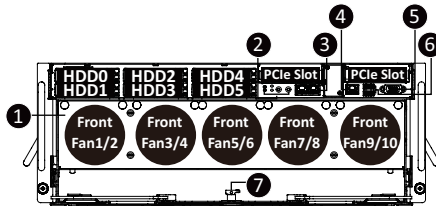

No.	Description	No.	Description
1.	HGX Tray	5.	VGA Port
2.	Front Panel LEDs and Buttons	6.	USB 3.0 Port x 2
3.	1 GbE LAN Port x 2	7.	HGX Tray Lock
4.	10/100/1000 Server Management LAN Port	--	--

NOTE! Green HDD Latch Supports NVMe



- Go to the section **2-3 Front Panel Buttons and LEDs** for detail description of function LEDs.

2-2 Rear View

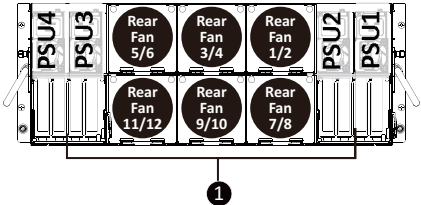

No.	Description
1.	PCIe Card Cage x 2

2-3 Front Panel LED and Buttons

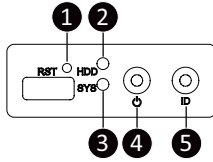

No.	Name	Color	Status	Description
1.	Reset Button			Press the button to reset the system.
2.	HDD Status LED	Green	On	HDD locate
			Blink	HDD access
		Amber	On	HDD fault
			Blink	HDD rebuilding
		N/A	Off	No HDD access or no HDD fault.
3.	System Status LED	Green	Solid On	System is operating normally.
			Solid On	Critical condition, may indicate: System fan failure System temperature
		Amber	Blink	Non-critical condition, may indicate: Redundant power module failure Temperature and voltage issue Chassis intrusion
			N/A	Off
4.	Power button with LED	Green	On	System is powered on
			Blink	System is in ACPI S1 state (sleep mode)
		N/A	Off	<ul style="list-style-type: none"> System is not powered on or in ACPI S5 state (power off) System is in ACPI S4 state (hibernate mode)
5.	ID Button			Press the button to activate system identification

2-4 Front Panel System LAN LEDs

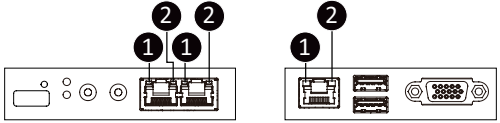

No.	Name	Color	Status	Description
1.	1GbE Speed LED	Yellow	On	1 Gbps data rate
		Green	On	100 Mbps data rate
		N/A	Off	10 Mbps data rate
2.	1GbE Link / Activity LED	Green	On	Link between system and network or no access
			Blink	Data transmission or reception is occurring.
		N/A	Off	No data transmission or reception is occurring.

2-5 Power Supply Unit (PSU) LED

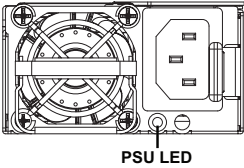

State	Description
OFF	No AC power to all power supplies
1Hz Green Blinking	AC present / only standby on / Cold redundant mode
2Hz Green Blinking	Power supply firmware updating mode
Amber	AC cord unplugged or AC power lost; with a second power supply in parallel still with AC input power
	Power supply critical event causing shut down: failure, OCP, OVP, fan failure and UVP
1Hz Amber Blinking	Power supply warning events where the power supply continues to operate: high temp, high power, high current and slow fan

2-6 Hard Disk Drive LEDs



RAID SKU		LED1	Locate	HDD Fault	Rebuilding	HDD Access	HDD Present (No Access)
No RAID configuration (via HBA)	Disk LED (LED on Back Panel)	Green	ON(*1)	OFF		BLINK (*2)	OFF
		Amber	OFF	OFF		OFF	OFF
	Removed HDD Slot (LED on Back Panel)	Green	ON(*1)	OFF		--	--
		Amber	OFF	OFF		--	--
RAID configuration (via HW RAID Card or SW RAID Card)	Disk LED	Green	ON	OFF		BLINK (*2)	OFF
		Amber	OFF	ON	(Low Speed: 2 Hz)	OFF	OFF
	Removed HDD Slot	Green	ON(*1)	OFF	(*3)	--	--
		Amber	OFF	ON	(*3)	--	--

LED 2	HDD Present	No HDD
Green	ON	OFF

NOTE:

*1: Depends on HBA/Utility Spec.

*2: Blink cycle depends on HDD's activity signal.

*3: If HDD is pulled out during rebuilding, the disk status of this HDD is regarded as faulty.

Chapter 3 System Hardware Installation



Pre-installation Instructions

Computer components and electronic circuit boards can be damaged by electrostatic discharge. Working on computers that are still connected to a power supply can be extremely dangerous. Follow the simple guidelines below to avoid damage to your computer or injury to yourself.

- Always disconnect the computer from the power outlet whenever you are working inside the computer case.
- If possible, wear a grounded wrist strap when you are working inside the computer case. Alternatively, discharge any static electricity by touching the bare metal system of the computer case, or the bare metal body of any other grounded appliance.
- Hold electronic circuit boards by the edges only. Do not touch the components on the board unless it is necessary to do so. Do not flex or stress the circuit board.
- Leave all components inside the static-proof packaging until you are ready to use the component for the installation.

3-1 Removing and Installing the Chassis Top Cover



Before you remove or install the chassis top cover

- Make sure the system is not turned on or connected to AC power.

Follow these instructions to remove/install the chassis top cover:

1. Push button to unlock the handle.
2. Pull the grip handle to open the panel cover.
3. Slide the cover towards the front of the system and then remove the cover in the direction indicated by the arrow.
4. Follow steps 1-3 in reverse order to re-install the top cover

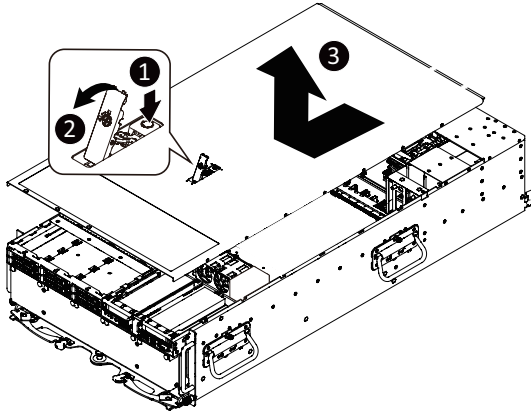

3-2 Removing and Installing the HGX Tray



Before you remove or install the HGX tray.

- Make sure the system is not turned on or connected to AC power.

Follow these instructions to remove/install the HGX tray:

1. Unlock the latch in the center of front system.
2. Pull the grip handles on the both sides of the system slide the tray to the front of the system at the same time to remove the tray.
3. Follow steps 1-2 in reverse order to re-install the HGX.

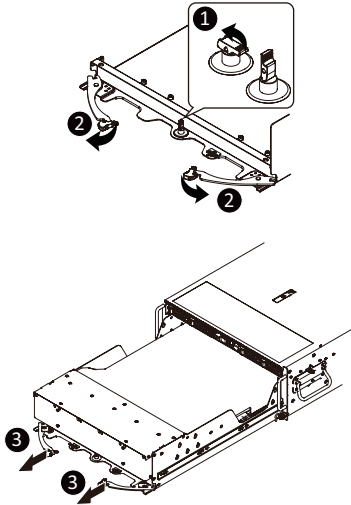

3-3 Removing and installing the Heat Sink



Read the following guidelines before you begin to remove/install the heat sink:

- Always turn off the computer and unplug the power cord from the power outlet before installing the heat sink to prevent hardware damage.
- Unplug all cables from the power outlets.
- Disconnect all telecommunication cables from their ports.
- Place the system unit on a flat and stable surface.
- Open the system according to the instructions.



WARNING!

Failure to turn off the server before you start installing components may cause serious damage. Do not attempt the procedures described in the following sections unless you are a qualified service technician.

Follow these instructions to remove/install the heat sink:

1. Loosen the captive screws securing the heat sink in place in reverse order (4→3→2→1).
2. Lift and remove the heat sink from the system.
3. To reinstall the heat sink reverse steps 1-2 while ensuring that you tighten the captive screws in sequential order (1→2→3→4) as seen in the image below.

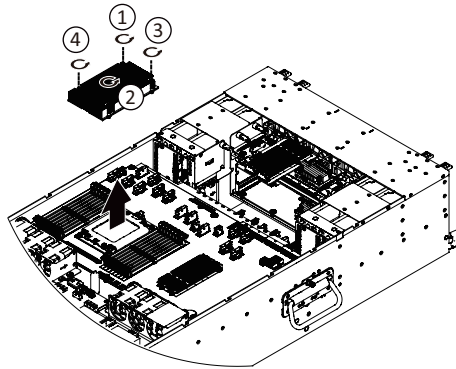

When installing the heat sink to CPU, use PHILLIPS #2-Lobe driver to tighten 4 captive nuts in sequence as 1-4. The screw tightening torque: 10 ± 0.5 kgf-cm.

3-4 Installing the CPU



Read the following guidelines before you begin to install the CPU:

- Make sure that the motherboard supports the CPU.
- Always turn off the computer and unplug the power cord from the power outlet before installing the CPU to prevent hardware damage.
- Unplug all cables from the power outlets.
- Disconnect all telecommunication cables from their ports.
- Place the system unit on a flat and stable surface.
- Open the system according to the instructions.



WARNING!

Failure to properly turn off the server before you start installing components may cause serious damage. Do not attempt the procedures described in the following sections unless you are a qualified service technician.

Follow these instructions to install the CPU:

1. Loosen the three captive screws securing the CPU cover in sequential order (1 → 2 → 3 → 4 → 5).
2. Flip open the CPU cover.
3. Install the CPU into place in the CPU socket.
4. Flip the CPU cover into place over the CPU socket.
5. Tighten the CPU cover screws in sequential order (1 → 2 → 3 → 4 → 5) to secure the CPU cover in place.
6. To remove the CPUs, follow steps 1-5 in reverse order.

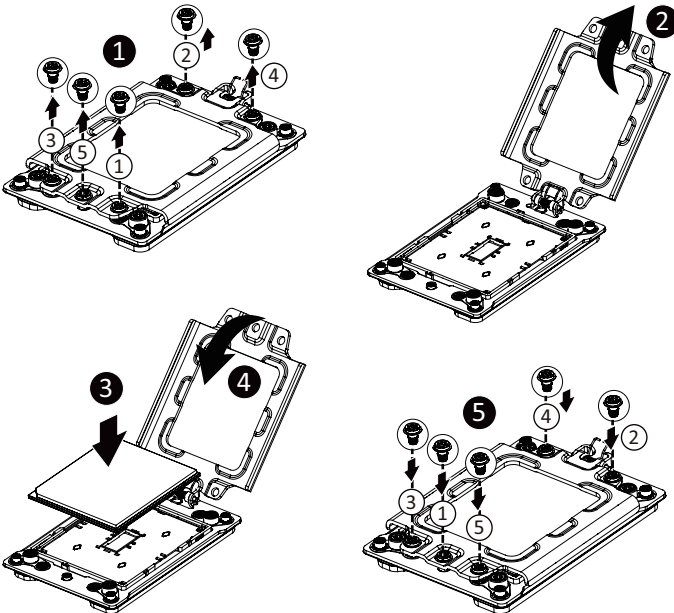

3-5 Installing the Memory



Read the following guidelines before you begin to install the memory:

- Make sure that the motherboard supports the memory. It is recommended that memory of the same capacity, brand, speed, and chips be used.
- Always turn off the computer and unplug the power cord from the power outlet before installing the memory to prevent hardware damage.
- Memory modules have a foolproof design. A memory module can be installed in only one direction. If you are unable to insert the memory, switch the direction.

3-5-1 Eight Channel Memory Configuration

This motherboard provides 16 DDR4 memory slots and supports Eight Channel Technology. After the memory is installed, the BIOS will automatically detect the specifications and capacity of the memory.

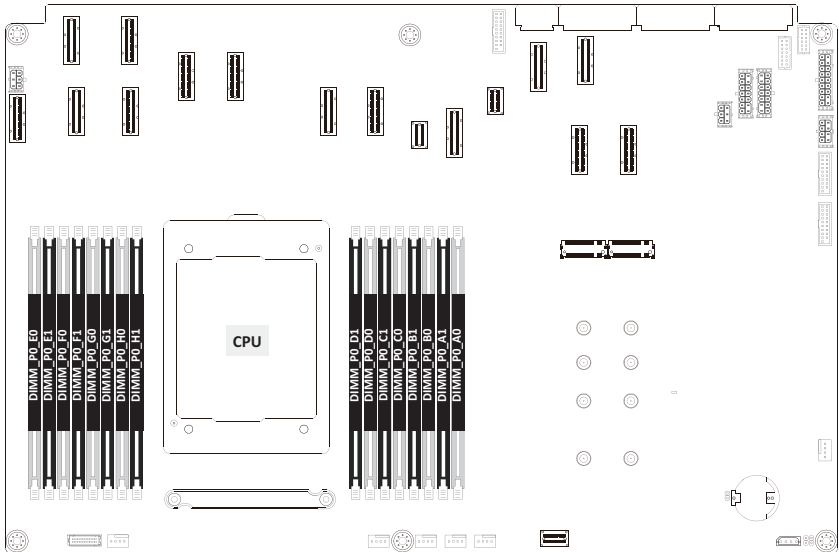

3-5-2 Installing the Memory



Before installing a memory module, make sure to turn off the computer and unplug the power cord from the power outlet to prevent damage to the memory module.

Be sure to install DDR4 DIMMs on this motherboard.

Follow these instructions to install the Memory:

1. Insert the DIMM memory module vertically into the DIMM slot, and push it down.
2. Close the plastic clip at both edges of the DIMM slots to lock the DIMM module.
3. Reverse the installation steps when you want to remove the DIMM module.

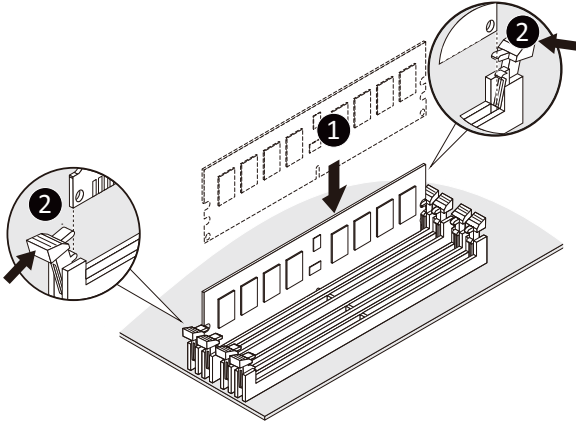

3-5-3 DIMM Population Table

Type	Ranks Per DIMM and Data Width	DIMM Capacity (GB)	Speed (MT/s); Voltage (V); Slots per Channel(SPC) and DIMM per Channel (DPC)		
			1 Slot per Channel	2 Slots per Channel	
		DIMM Density	1DPC	1DPC	2DPC
		8Gb	1.2V	1.2V	1.2V
RDIMM	SRx4	16GB	3200	3200	3200
RDIMM	DRx8	16GB			

3-5-4 Altra Platform DDR4 Suggest Configuration Table

Memory Q'ty for each CPU	CPU0															
	E0	E1	F0	F1	G0	G1	H0	H1	D1	D0	C1	C0	B1	B0	A1	A0
1 DIMM																v
2 DIMM	v															v
4 DIMM	v		v												v	v
6 DIMM	v		v		v							v		v		v
8 DIMM	v		v		v		v			v		v		v		v
12 DIMM	v	v	v	v	v	v					v	v	v	v	v	v
16 DIMM	v	v	v	v	v	v	v	v	v	v	v	v	v	v	v	v

3-6 Installing the PCI Expansion Card



- Voltages can be present within the server whenever an AC power source is connected. This voltage is present even when the main power switch is in the off position. Ensure that the system is powered-down and all power sources have been disconnected from the server prior to installing a PCIe card.

Failure to observe these warnings could result in personal injury or damage to equipment.

Follow these instructions to install the PCI Expansion card:

1. Press the release latch.
2. Simultaneously pulling up the tray handle for the PCIe card cage.
3. Pull the cage out of the system.
4. Align the PCIe card onto the slot and push in the direction of the arrow until the PCIe card sits in the PCIe card connector.
5. Secure the PCIe card with the screw.
6. To install the PCIe card cage, push the cage back into the system. Reverse the previous steps to remove the PCI expansion card.

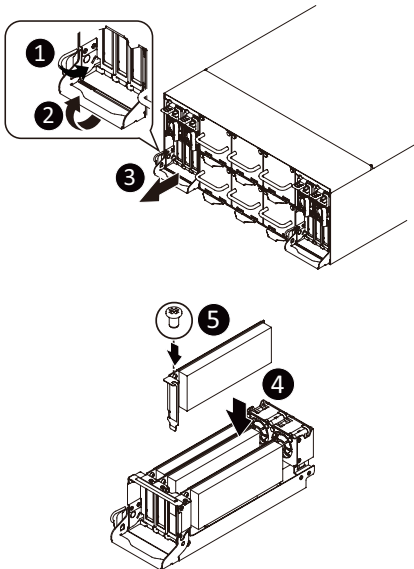

3-7 Installing the Hard Disk Drive



Read the following guidelines before you begin to install the hard disk drive:

- Take note of the drive tray orientation before sliding it out.
- The tray will not fit back into the bay if inserted incorrectly.
- Make sure that the hard disk drive is connected to the hard disk drive connector on the backplane.

Follow these instructions to install a 2.5" hard disk drive:

1. Press the release button.
2. Extend the locking lever.
3. Pull the locking lever in the direction indicated to remove the HDD tray.
4. Align the hard disk drive with the positioning stud on the HDD tray.
5. Slide the hard disk drive into the HDD tray.
6. Reinsert the HDD tray into the slot and close the locking lever.

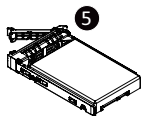
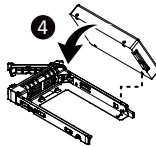
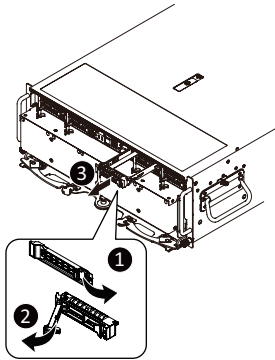

3-8 Installing the M.2 Device and Heat Sink



WARNING:

Installation of the thermal pad over the M.2 device is required when installing an M.2 device. Lack of the thermal pad may result in the system overheating and throttle the system performance.



CAUTION

The position of the stand-off screw will depend on the size of the M.2 device. The stand-off screw is pre-installed for 22110 cards as standard. Refer to the size of the M.2 device and change the position of the stand-off screw accordingly.

Follow these instructions to install the M.2 device and heat sink:

1. Insert the M.2 device into the M.2 connector.
2. Press down on the M.2 device.
3. Install the thermal pad of the M.2 device to the M.2 device.
4. Press down on the thermal pad.
5. Secure the M.2 device and its thermal pad to the motherboard with a single screw.
6. Reverse steps 1-4 to remove the M.2 device.

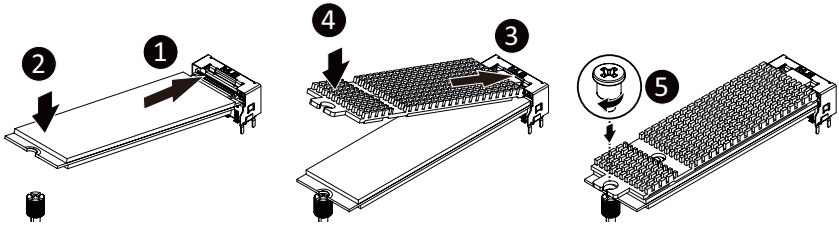

3-9 Replacing the System Fan Module



CAUTION!

Before you remove or install the system fans follow these steps:

- Make sure the system is not turned on or connected to AC power.
- Disconnect all necessary cable connections. Failure to observe these warnings could result in personal injury or damage to the equipment

Follow these instructions to replace the fan module:

1. Pull up to remove the fan module by using handle.
2. Reverse the previous steps to install the replacement fan module.

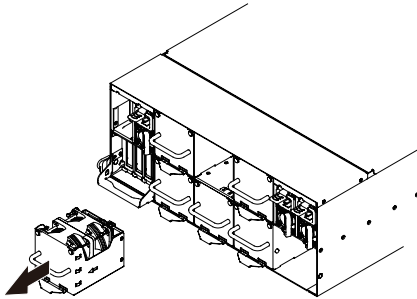

3-10 Removing and Installing the Power Supply



CAUTION!

- In order to reduce the risk of injury from electric shock, disconnect AC power from the power supply before removing the power supply from the system.
- Please see Section 2-2 "Rear View" for installation sequence.

Follow these instructions to replace the power supply:

1. Flip and then grasp the power supply handle.
2. Press the retaining clip on the top side of the power supply in the direction indicated.
3. Pull out the power supply using the handle.
4. Insert the replacement power supply firmly into the chassis. Connect the AC power cord to the replacement power supply.

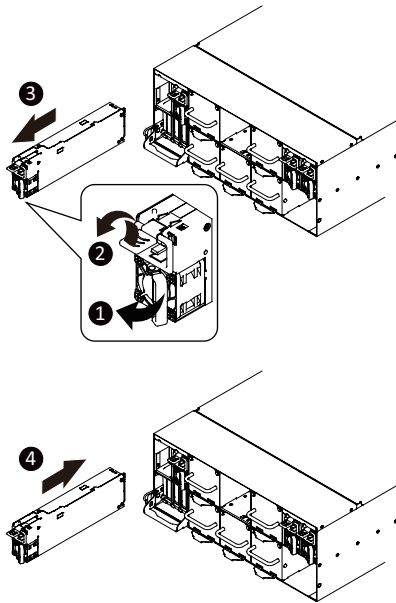

3-11 Cable Connection

3-11-1 Motherboard to PCIe Board and Front IO Board

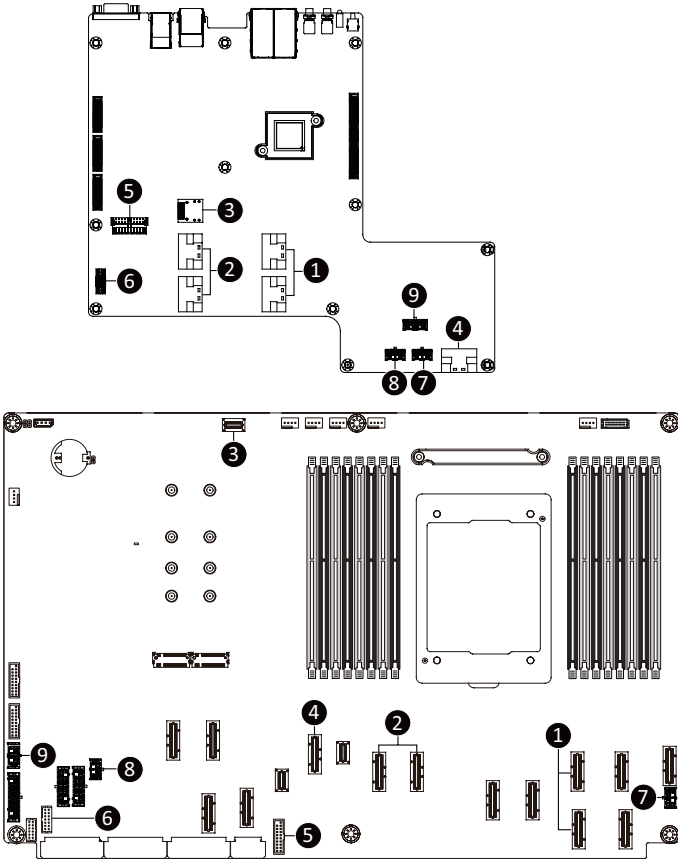

No.	Description
1.	PCIe Slot Signal Cable (for Front Side Slot#0)
2.	PCIe Slot Signal Cable (for Front Side Slot#1)
3.	MLAN/NCSI Cable
4.	Front Panel Signal Cable
5.	Front USB 3.0 Cable
6.	Front VGA Cable
7.	Front PCIe Power Cable
8.	Front PCIe Power Cable
9.	Front Panel Power Cable

3-11-2 Motherboard to PCIe Board and HDD Back Plane Board

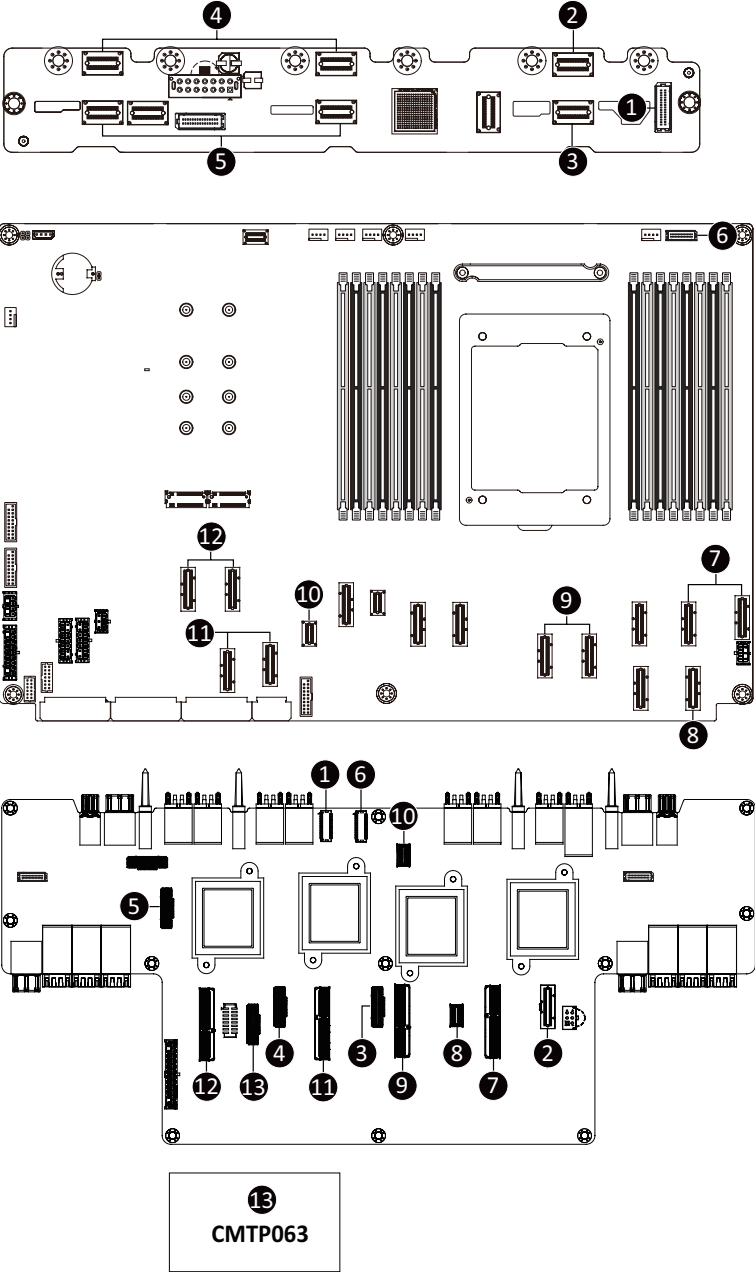

No.	Description
1.	Back Plane Board SATA Cable
2.	NVMe HDD #0
3.	NVMe HDD #1
4.	NVMe HDD #2/#4
5.	NVMe HDD #3/#5
6.	Back Plane Board Signal Cable
7.	PCIe Slot Signal Cable
8.	PCIe Slot Signal Cable
9.	PCIe Slot Signal Cable
10.	PCIe to PDB Signal Cable
11.	PCIe Slot Signal Cable
12.	PCIe Slot Signal Cable
13.	PCIe to Rear Side M.2 Bridge Board (CMTP063)

Chapter 4 Motherboard Components

4-1 Motherboard Components

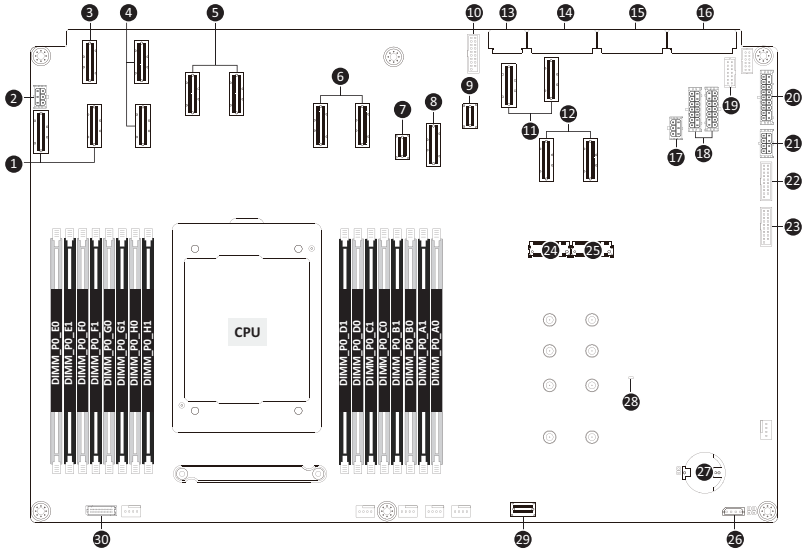

Item	Description
1	SlimLine Connectors (PCIe Gen4 Signal)
2	2 x 3 Pin PCIe Power Connector
3	SlimLine Connector (PCIe Gen4 Signal)
4	SlimLine Connectors (PCIe Gen4 Signal)
5	SlimLine Connectors (PCIe Gen4 Signal)
6	SlimLine Connectors (PCIe Gen4 Signal)
7	SlimLine Connector (PCIe Gen4 Signal)
8	SlimLine Connector (Front Panel Sideband Signal)
9	SlimLine Connector (Power On Signal)
10	USB 3.0 Connector
11	SlimLine Connectors (PCIe Gen4 Signal)
12	SlimLine Connectors (PCIe Gen4 Signal)
13	CPU Power Connector
14	System Power Connector
15	System Power Connector
16	System Power Connector
17	2 x 3 Pin PCIe Power Connector
18	2 x 7 Pin HDD Back Plane Board Power Connectors
19	Front Panel VGA Connector
20	2 x 9 Pin System FAN Power Connector
21	2 x 4 Pin Front Panel Power Connector
22	USB 3.0 Connector
23	USB 3.0 Connector

Item	Description
24	M.2 Connector (PCIe Gen 4 x4, NGFF-22110)
25	M.2 Connector (PCIe Gen 4 x4, NGFF-22110)
26	IPMB Connector
27	System Battery
28	BMC Firmware Readiness LED
29	SlimLine Connector (MLAN/NSCI Signal)
30	2 x 15 Pin HDD Back Plane Board Connector

4-2 Jumper Setting

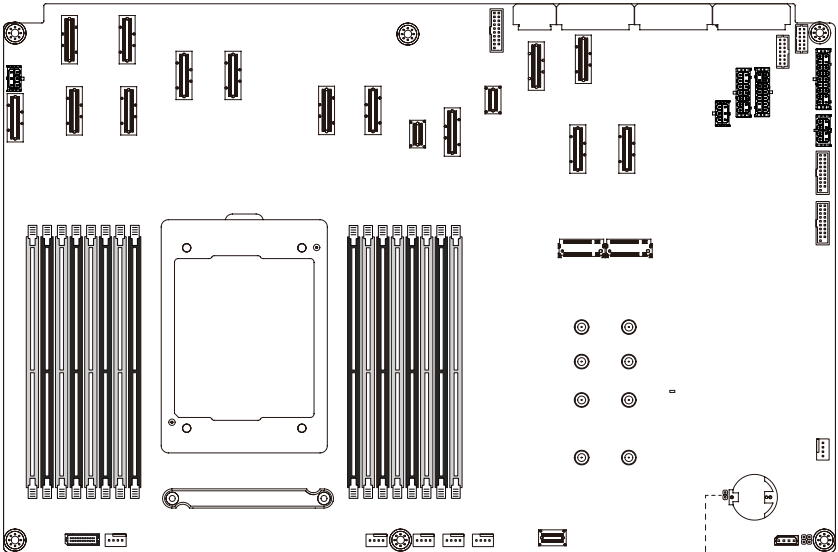

Clear CMOS CLR_CMOS	 Normal Operation (Default)
	 Clear CMOS data

4-3 Backplane Board Storage Connector

4-3-1 CBPG060

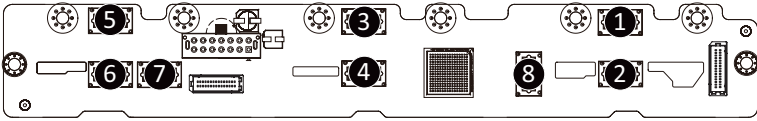

Item	Description
1	SlimLine Connector (U2_0)
2	SlimLine Connector (U2_1)
3	SlimLine Connector (U2_2)
4	SlimLine Connector (U2_3)
5	SlimLine Connector (U2_4)
6	SlimLine Connector (U2_5)
7	SlimLine Connector (SATA0)
8	SlimLine Connector (SATA1)

Chapter 5 BIOS Setup

BIOS (Basic Input and Output System) records hardware parameters of the system in the EFI on the motherboard. Its major functions include conducting the Power-On Self-Test (POST) during system startup, saving system parameters, loading the operating system etc. The BIOS includes a BIOS Setup program that allows the user to modify basic system configuration settings or to activate certain system features. When the power is turned off, the battery on the motherboard supplies the necessary power to the CMOS to keep the configuration values in the CMOS.

To access the BIOS Setup program, press the key during the POST when the power is turned on.



- BIOS flashing is potentially risky, if you do not encounter any problems when using the current BIOS version, it is recommended that you don't flash the BIOS. To flash the BIOS, do it with caution. Inadequate BIOS flashing may result in system malfunction.
- It is recommended that you not alter the default settings (unless you need to) to prevent system instability or other unexpected results. Inadequately altering the settings may result in system's failure to boot. If this occurs, try to clear the CMOS values and reset the board to default values. (Refer to the **Exit** section in this chapter or introductions of the battery/clearing CMOS jumper in Chapter 4 for how to clear the CMOS values.)

BIOS Setup Program Function Keys

<<-><->>	Move the selection bar to select the screen
<↑><↓>	Move the selection bar to select an item
<+>	Increase the numeric value or make changes
<->	Decrease the numeric value or make changes
<Enter>	Execute command or enter the submenu
<Esc>	Main Menu: Exit the BIOS Setup program Submenus: Exit current submenu
<F1>	Show descriptions of general help
<F3>	Restore the previous BIOS settings for the current submenus
<F9>	Load the Optimized BIOS default settings for the current submenus
<F10>	Save all the changes and exit the BIOS Setup program

■ **Main**

This setup page includes all the items of the standard compatible BIOS.

■ **Advanced**

This setup page includes all the items of AMI BIOS special enhanced features.

(ex: Auto detect fan and temperature status, automatically configure hard disk parameters.)

■ **Chipset**

This setup page includes all the submenu options for configuring the function of processor, network, North Bridge, South Bridge, and System event logs.

■ **Server Management**

Server additional features enabled/disabled setup menus.

■ **Security**

Change, set, or disable supervisor and user password. Configuration supervisor password allows you to restrict access to the system and BIOS Setup.

A supervisor password allows you to make changes in BIOS Setup.

A user password only allows you to view the BIOS settings but not to make changes.

■ **Boot**

This setup page provides items for configuration of the boot sequence.

■ **Save & Exit**

Save all the changes made in the BIOS Setup program to the CMOS and exit BIOS Setup. (Pressing <F10> can also carry out this task.)

Abandon all changes and the previous settings remain in effect. Pressing <Y> to the confirmation message will exit BIOS Setup. (Pressing <Esc> can also carry out this task.)

5-1 The Main Menu

Once you enter the BIOS Setup program, the Main Menu (as shown below) appears on the screen. Use arrow keys to move among the items and press <Enter> to accept or enter other sub-menu.

Main Menu Help

The on-screen description of a highlighted setup option is displayed on the bottom line of the Main Menu.

Submenu Help

While in a submenu, press <F1> to display a help screen (General Help) of function keys available for the menu. Press <Esc> to exit the help screen. Help for each item is in the Item Help block on the right side of the submenu.



- When the system is not stable as usual, select the **Restore Defaults** item to set your system to its defaults.
- The BIOS Setup menus described in this chapter are for reference only and may differ by BIOS version.

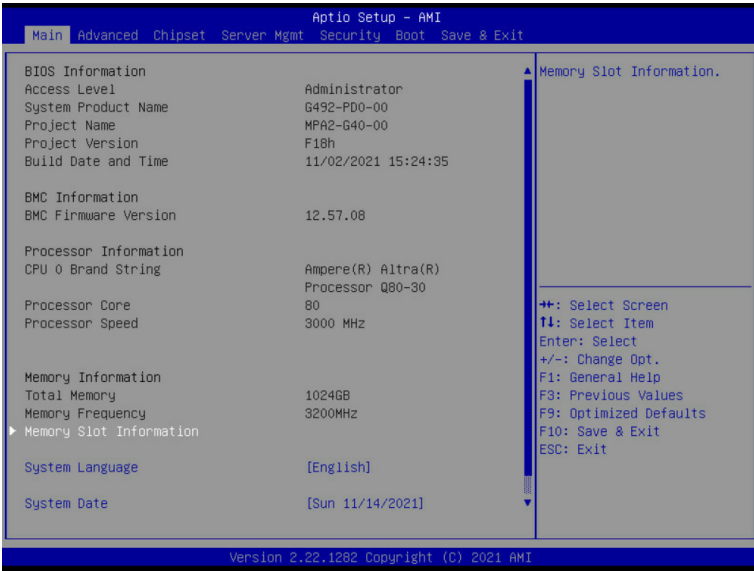

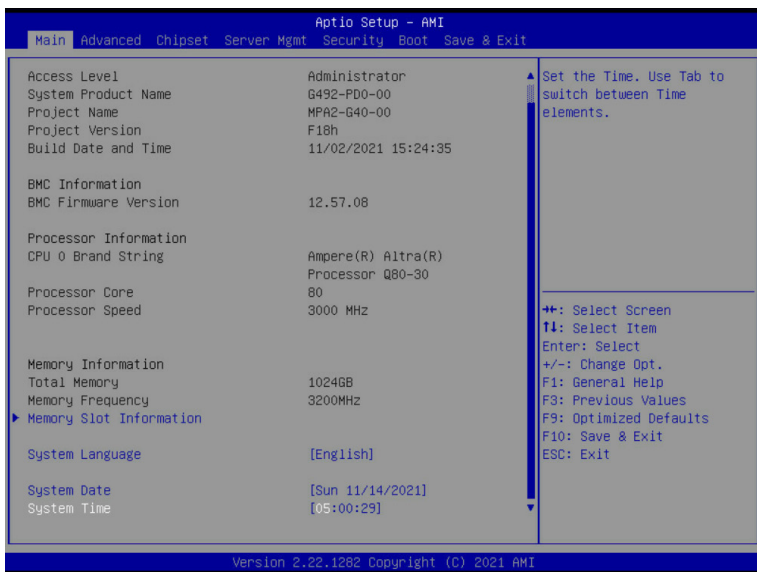

Parameter	Description
BIOS Information	
Access Level	Displays the privileges level information.
System Project Name	Displays the system project name information.
Project Name	Displays the motherboard project name information.
Project Version	Displays version number of the BIOS setup utility.
Build Date and Time	Displays the date and time when the BIOS setup utility was created.
BMC Information ^(Note1)	
BMC Firmware Version ^(Note1)	Displays BMC firmware version information.
Processor Information	
CPU Brand String / Processor Core/ Processor Speed	Displays the technical specifications for the installed processor.
Memory Information	
Total Memory ^(Note2)	Displays the total memory size of the installed memory.
Memory Frequency ^(Note2)	Displays the frequency information of the installed memory.
Memory Slot Information	Press [Enter] to view installed memory slot information.

(Note1) Functions available on selected models.

(Note2) This section will display capacity and frequency information of the memory that the customer has installed.

Parameter	Description
System Language	Option: English.
System Date	Sets the date following the weekday-month-day-year format.
System Time	Sets the system time following the hour-minute-second format.

5-2 Advanced Menu

The Advanced Menu displays submenu options for configuring the function of various hardware components. Select a submenu item, then press <Enter> to access the related submenu screen.

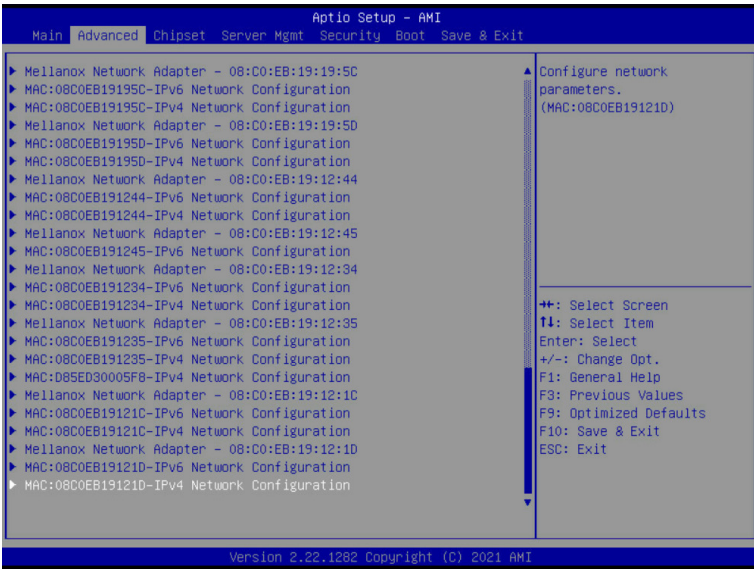
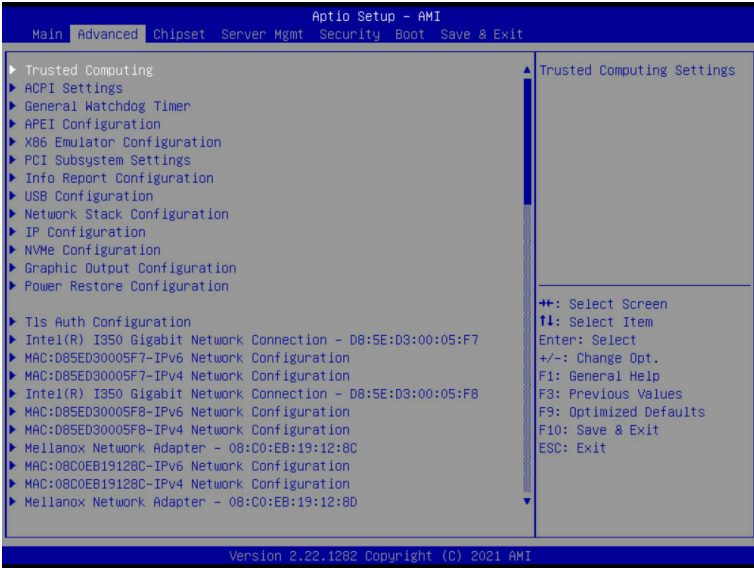

5-2-1 Trusted Computing

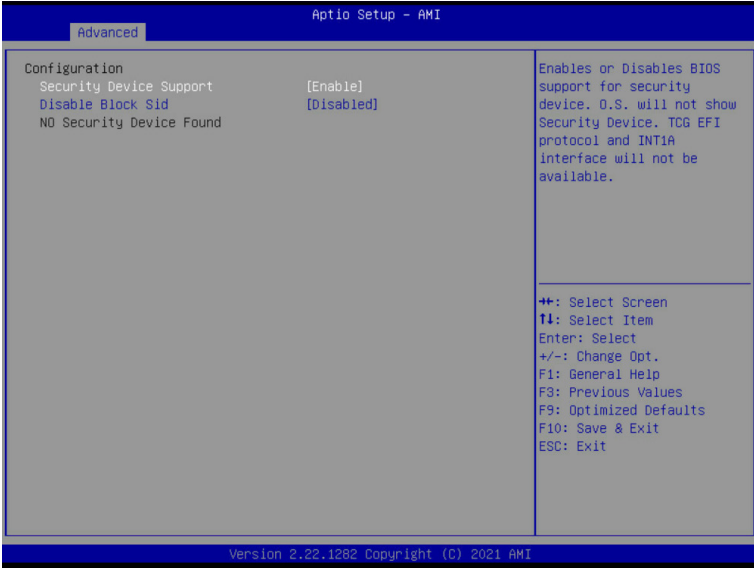

Parameter	Description
Configuration	
Security Device Support	<p>Enable/Disable BIOS support for security device. OS will not show security device. TCG EFI protocol and INT1A interface will not be available.</p> <p>Options available: Enable, Disable. Default setting is Enable.</p>
Disable Block Sid	<p>Override to allow SID authentication in TCG Storage device.</p> <p>Options available: Enabled, Disabled. Default setting is Disabled.</p>

5-2-2 ACPI Settings

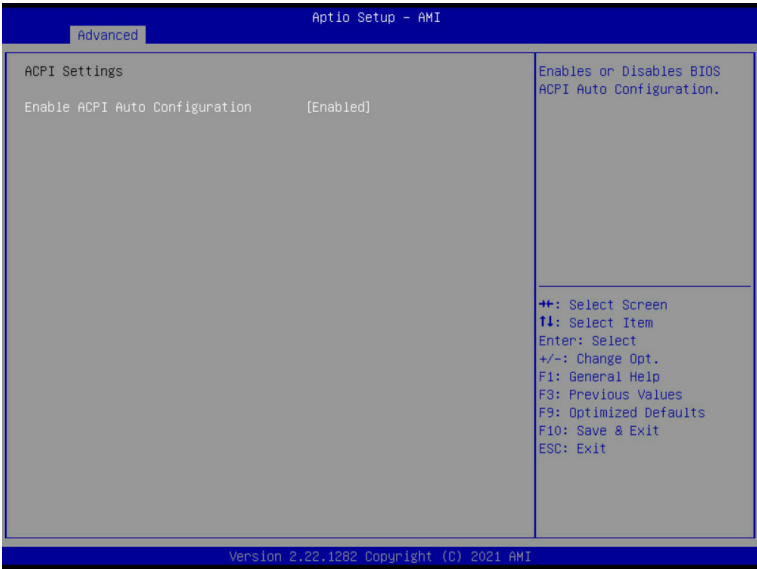

Parameter	Description
ACPI Settings	
Enable ACPI Auto Configuration	Enable/Disable BIOS ACPI auto configuration. Options available: Disabled, Enabled. Default setting is Enabled .

5-2-3 General Watchdog Timer

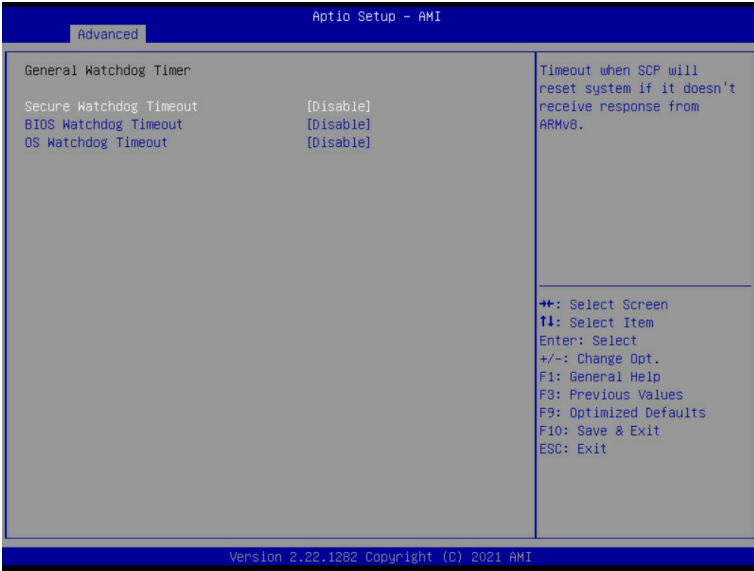

Parameter	Description
General Watchdog Timer	
Secure Watchdog Timeout	Timeout when SCP will reset system if it doesn't receive response from ARMv8. Options available: Disable, 5 minutes, 6 minutes, 10 minutes, 15 minutes, 20 minutes. Default setting is Disable .
BIOS Watchdog Timeout	Options available: Disable, 5 minutes, 6 minutes, 10 minutes, 15 minutes, 20 minutes. Default setting is Disable .
OS Watchdog Timeout	Options available: Disable, 3 minutes, 4 minutes, 5 minutes, 6 minutes, 10 minutes, 15 minutes, 20 minutes. Default setting is Disable .

5-2-4 APEI Configuration

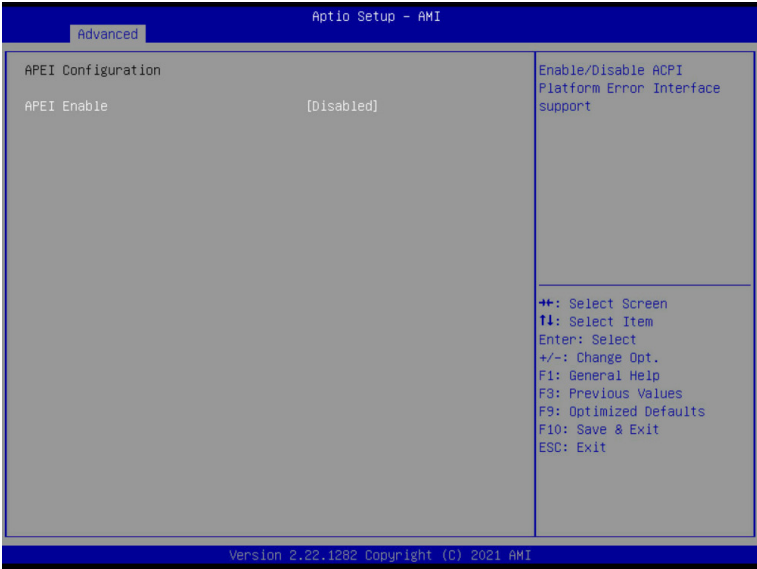

Parameter	Description
APEI Configuration	
APEI Enable	Enable/Disable ACPI platform Error Interface support. Options available: Disabled, Enabled. Default setting is Disabled .

5-2-5 X86 Emulation Configuration

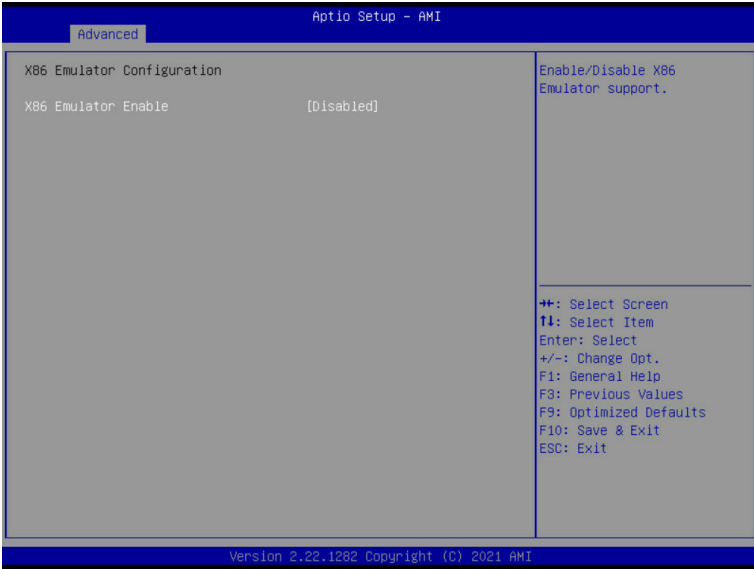

Parameter	Description
X86 Emulator Configuration	
X86 Emulator Enable	Enable/Disable X86 Emulator support. Options available: Enabled, Disabled. Default setting is Disabled .

5-2-6 PCI Subsystem Settings

Aptio Setup - AMI

Advanced

<p>AMI PCI Driver Version : A5.01.20</p> <p>PCI Settings Common for all Devices: SR-IOV Support [Enabled]</p> <p>Change Settings of the Following PCI Devices:</p> <ul style="list-style-type: none"> ▶ Slot # 0 Occupied [Bridge Device] ▶ Slot # 4 Occupied [Bridge Device] ▶ Slot # 8 Occupied [Mass Storage Controller] ▶ Slot #16 Occupied [Network Controller] ▶ Slot #26 Occupied [Network Controller] ▶ OnBoard Device [Network Controller] ▶ OnBoard Device [Network Controller] ▶ OnBoard Device [Display Controller] ▶ OnBoard Device [Bridge Device] ▶ OnBoard Device [Serial Bus Controller] <p>WARNING: Changing PCI Device(s) settings may have unwanted side effects! System may HANG! PROCEED WITH CAUTION.</p>	<p>If system has SR-IOV capable PCIe Devices, this option Enables or Disables Single Root IO Virtualization Support.</p> <hr/> <p> ++: Select Screen T1: Select Item Enter: Select +/-: Change Opt. F1: General Help F3: Previous Values F9: Optimized Defaults F10: Save & Exit ESC: Exit </p>
---	---

Version 2.22.1282 Copyright (C) 2021 AMI

Aptio Setup - AMI

Advanced

<p>Slot # 0 Occupied [Bridge Device] Location: S:00h B:01h D:00h F:00h; VID:1000 DID:C010 Supports: PCIe GEN1[X]; GEN2[X]; GEN3[X]; GEN4[X]; ARI[]; HP[]</p> <p> PCI Latency Timer [32 PCI Bus Clocks] PCI-X Latency Timer [64 PCI Bus Clocks] VGA Palette Snoop [Disabled] PERR# Generation [Disabled] SERR# Generation [Enabled] </p> <p> Disable PCIe Init [Disabled] Disable PCIe GEN 2 [Disabled] </p> <ul style="list-style-type: none"> ▶ PCI Express GEN 1 Settings ▶ PCI Express GEN 2 Settings 	<p>Value to be programmed into PCI Latency Timer Register.</p> <hr/> <p> ++: Select Screen T1: Select Item Enter: Select +/-: Change Opt. F1: General Help F3: Previous Values F9: Optimized Defaults F10: Save & Exit ESC: Exit </p>
---	---

Version 2.22.1282 Copyright (C) 2021 AMI

Parameter	Description
AMI PCI Driver Version	Displays the AMI PCI Bus Driver version information
PCI Settings Common for all Devices:	
SR-IOV Support	Enable/Disable Single Root IO virtualization support. Options available: Disabled, Enabled. Default setting is Enabled .
Change Settings of the following PCI Devices:	
Slot #0/4/8/16/26 Occupied OnBoard Device	<p>Press [Enter] to configure advanced items.</p> <ul style="list-style-type: none"> ◆ PCI Latency Timer <ul style="list-style-type: none"> – Value to be programmed into PCI latency timer register. – Options available: 32,64,96,128,160,192,224,248 PCI Bus Clocks. Default setting is 32 PCI Bus Clocks. ◆ PCI-X Latency Timer <ul style="list-style-type: none"> – Value to be programmed into PCI latency timer register. – Options available: 32,64,96,128,160,192,224,248 PCI Bus Clocks. Default setting is 32 PCI Bus Clocks. ◆ VGA Palette Snoop <ul style="list-style-type: none"> – Enable/Disable VGA Palette Registers Snooping. – Options available: Disabled, Enabled. Default setting is Disabled. ◆ PERR# Generation <ul style="list-style-type: none"> – Enable/Disable PCI Device to Generate PERR#. – Options available: Disabled, Enabled. Default setting is Disabled. ◆ SERR# Generation <ul style="list-style-type: none"> – Enable/Disable PCI Device to Generate SERR#. – Options available: Disabled, Enabled. Default setting is Disabled. ◆ Disable PCIe Init <ul style="list-style-type: none"> – Disable BIOS built-in PCI Express initialization for currently selected and down stream PCI device(s). – Options available: Disabled, Enabled. Default setting is Disabled. ◆ Disable PCIe GEN2 <ul style="list-style-type: none"> – Disable BIOS built-in PCI Express GEN2 initialization for currently selected and down stream PCI device(s). – Options available: Disabled, Enabled. Default setting is Disabled.
PCI Express GEN 1 Settings	Press [Enter] to configure advanced items.
PCI Express GEN 2 Settings	Press [Enter] to configure advanced items.

5-2-6-1 PCI Express GEN 1 Settings

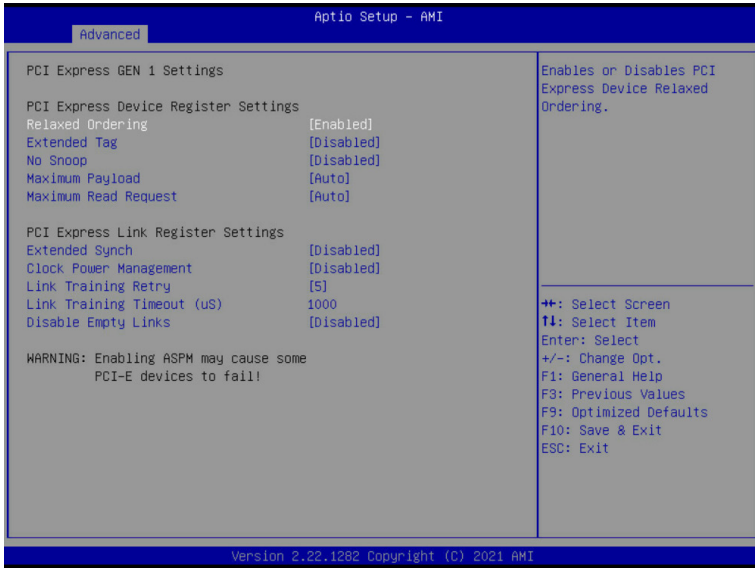

Parameter	Description
PCI Express Device Register Settings	
Relaxd Ordering	Enable/disable PCI Express Device Relaxed Ordering. Options available: Enabled, Disabled. Default setting is Enabled .
Extended Tag	If enabled, allows device to use 8-bit tag field as a requester. Options available: Enabled, Disabled. Default setting is Disabled .
No Snoop	Enable/disable PCI Express Device No Snoop option. Options available: Enabled, Disabled. Default setting is Disabled .
Maximum Payload	Set maximum payload of PCI express device or allow system BIOS to select the value. Options available: Auto, 128 Bytes, 256 Bytes, 512 Bytes. Default setting is Auto .
Maximum Read Request	Set maximum Read Request size of PCI express device or allow system BIOS to select the value. Options available: Auto, 128 Bytes, 256 Bytes, 512 Bytes, 1024 Bytes, 2048 Bytes, 4096 Bytes. Default setting is Auto .
PCI Express Link Register Settings	
Extended Synch	If enabled, allows generation of extended synchronization patterns. Options available: Enabled, Disabled. Default setting is Disabled .

Parameter	Description
Clock Power Management	<p>If supported by hardware and set to "Enabled", the device is permitted to use CLKREQ# signal for power management of Link clock in accordance to protocol defined in appropriate form factor specification.</p> <p>Options available: Enabled, Disabled. Default setting is Disabled.</p>
Link Training Retry	<p>Defines number of Retry attempts software will take to retrain the link if previous training attempt was unsuccessful.</p> <p>Options available: Disabled, 2, 3, 5. Default setting is 5.</p>
Link Training Timeout (uS)	<p>Defines number of microseconds software will wait before polling 'Link Training' bit in link status register. Value range from 10 to 10000 uS.</p>
Disable Empty Links	<p>In order to save power, software will disable unpopulated PCI express links, if this option set to "Disable Link.</p> <p>Options available: Enabled, Disabled. Default setting is Disabled.</p>

5-2-6-2 PCI Express GEN 2 Settings

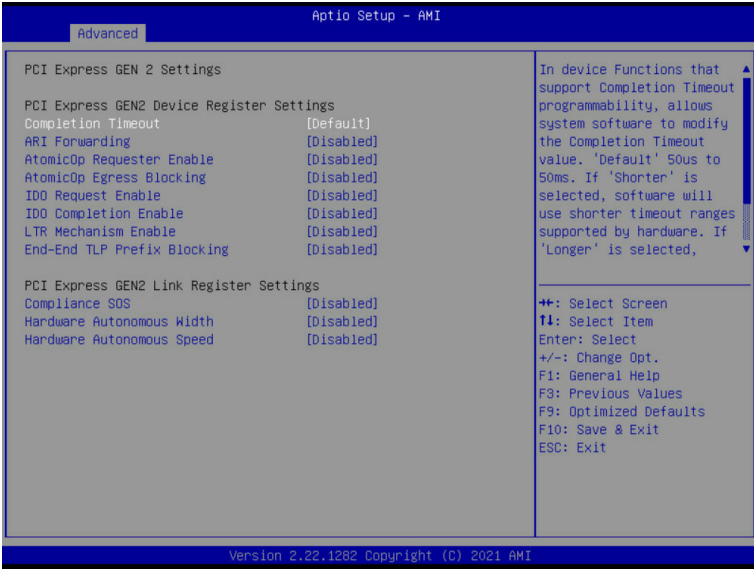

Parameter	Description
PCI Express GEN2 Device Register Settings	
Completion Timeout	In device functions that support completion timeout programmability, allows system software to modify the completion timeout value. 'Default' 50us to 50ms. If 'Shorter' is selected, software will use shorter timeout ranges supported by hardware. If 'Longer' is selected, software will use longer timeout ranges. Options available: Default, Shorter, Longer, Disabled. Default setting is Default .
ARI Forwarding	If supported by hardware and set to 'Enabled', the Downstream Port disables its traditional Device Number field being 0 enforcement when turning a Type1 Configuration Request into a Type0 Configuration Request, permitting access to Extended Functions in an ARI Device immediately below the Port. Options available: Enabled, Disabled. Default setting is Disabled .
AtomicOp Requester Enable	If supported by hardware and set to 'Enabled', this function initiates AtomicOp Requests only if Bus Master Enable bit is in the Command Register Set.. Options available: Enabled, Disabled. Default setting is Disabled .

Parameter	Description
AtomicOp Egress Blocking	If supported by hardware and set to 'Enabled', outbound AtomicOp Requests via Egress Ports will be blocked. Options available: Enabled, Disabled. Default setting is Disabled .
IDO Request Enable	If supported by hardware and set to 'Enabled', this permits setting the number of ID-Based Ordering (IDO) bit (Attribute[2]) requests to be initiated. Options available: Enabled, Disabled. Default setting is Disabled .
IDO Completion Enable	If supported by hardware and set to 'Enabled', this permits setting the number of ID-Based Ordering (IDO) bit (Attribute[2]) requests to be initiated. Options available: Enabled, Disabled. Default setting is Disabled .
LTR Mechanism Enable	If supported by hardware and set to 'Enabled', this enables the Latency Tolerance Reporting (LTR) Mechanism. Options available: Enabled, Disabled. Default setting is Disabled .
End-End TLP Prefix Blocking	If supported by hardware and set to 'Enabled', this function will block forwarding of TLPs containing End-End TLP Prefixes. Options available: Enabled, Disabled. Default setting is Disabled .
PCI Express GEN2 Link Register Settings	
Compliance SOS	If supported by hardware and set to 'Enabled', this will force LTSSM to send SKP Ordered Sets between sequences when sending Compliance Pattern or Modified Compliance Pattern. Options available: Enabled, Disabled. Default setting is Disabled .
Hardware Autonomous Width	If supported by hardware and set to 'Disabled', this will disable the hardware's ability to change link width except width size reduction for the purpose of correcting unstable link operation. Options available: Enabled, Disabled. Default setting is Disabled .
Hardware Autonomous Speed	If supported by hardware and set to 'Disabled', this will disable the hardware's ability to change link speed except speed rate reduction for the purpose of correcting unstable link operation. Options available: Enabled, Disabled. Default setting is Disabled .

5-2-7 Info Report Configuration

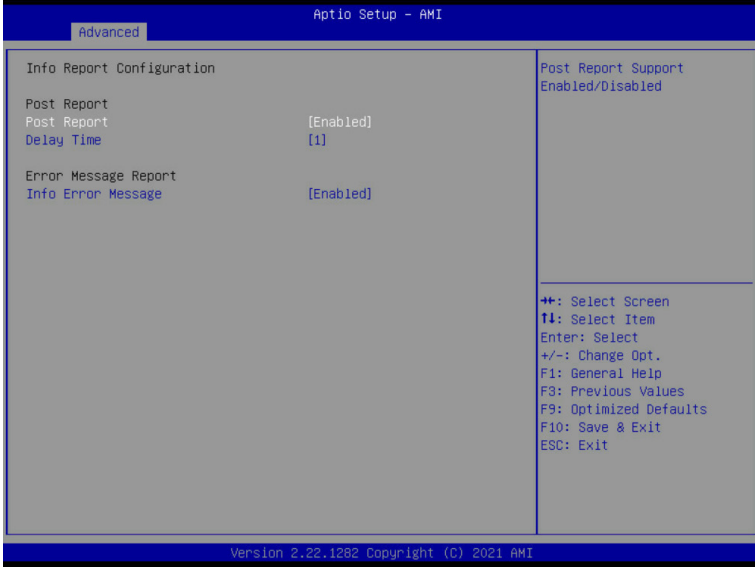

Parameter	Description
Post Report	
Post Report	Enable/disable post report support. Options available: Enabled, Disabled. Default setting is Enabled .
Delay Time	Options available: 0,1,2,3,4,5,6,7,8,9,10, Until Press ESC. Default setting is 1.
Error Message Report	
Info Error Message	Enable/disable Info error message support. Options available: Enabled, Disabled. Default setting is Enabled .

5-2-8 USB Configuration

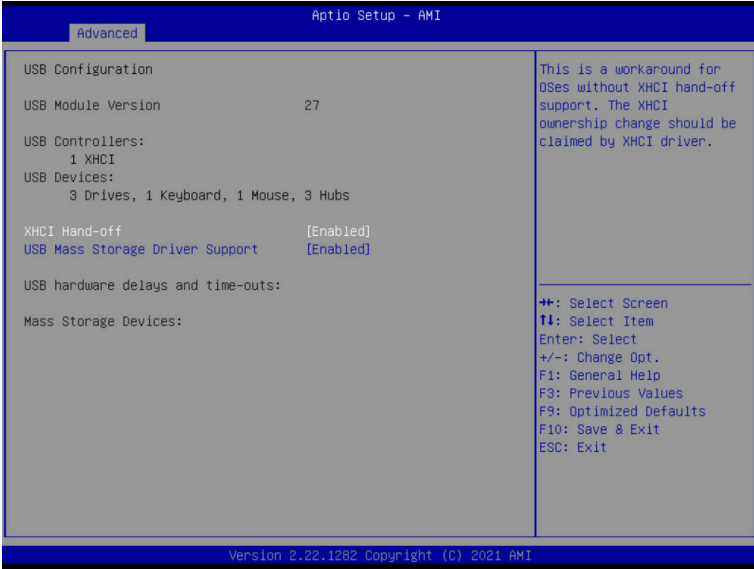

Parameter	Description
USB Configuration	
USB Module Version	Displays the USB module version information.
USB Controllers	Displays the supported USB controllers.
USB Devices:	Displays the USB devices connected to the system.
XHCI Hand-off	Enable/Disable the XHCI (USB 3.0) Hand-off support. Options available: Enabled, Disabled. Default setting is Enabled .
USB Mass Storage Driver Support ^(Note)	Enable/Disable the USB Mass Storage Driver Support. Options available: Enabled, Disabled. Default setting is Enabled .

(Note) This item is present only if you attach USB devices.

5-2-9 Network Stack Configuration

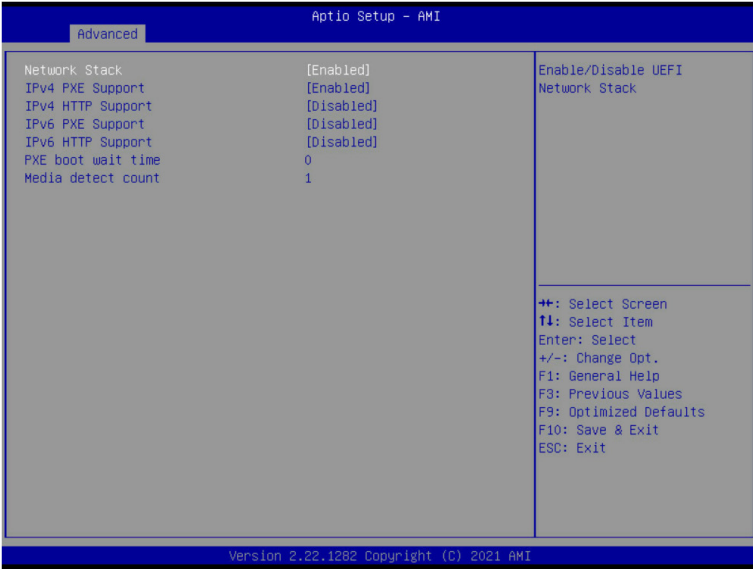

Parameter	Description
Network Stack	Enable/Disable the UEFI network stack. Options available: Enabled, Disabled. Default setting is Enabled .
Ipv4 PXE Support ^(Note)	Enable/Disable the Ipv4 PXE feature. Options available: Enabled, Disabled. Default setting is Enabled .
Ipv4 HTTP Support ^(Note)	Enable/Disable the Ipv4 HTTP feature. Options available: Enabled, Disabled. Default setting is Disabled .
Ipv6 PXE Support ^(Note)	Enable/Disable the Ipv6 PXE feature. Options available: Enabled, Disabled. Default setting is Enabled .
Ipv6 HTTP Support ^(Note)	Enable/Disable the Ipv6 HTTP feature. Options available: Enabled, Disabled. Default setting is Disabled .
PXE boot wait time ^(Note)	Wait time in seconds to press ESC key to abort the PXE boot. Press the <+> / <-> keys to increase or decrease the desired values.
Media detect count ^(Note)	Number of times the presence of media will be checked. Press the <+> / <-> keys to increase or decrease the desired values.

(Note) This item appears when **Network Stack** is set to **Enabled**.

5-2-10 IP Configuration



Parameter	Description
IP Configuration Settings	
Provides the Options to Configure the IP Address	
Auto Configuration	Options available: Disabled, Every Boot, On Demand. Default setting is Disabled .

5-2-11 NVMe Configuration

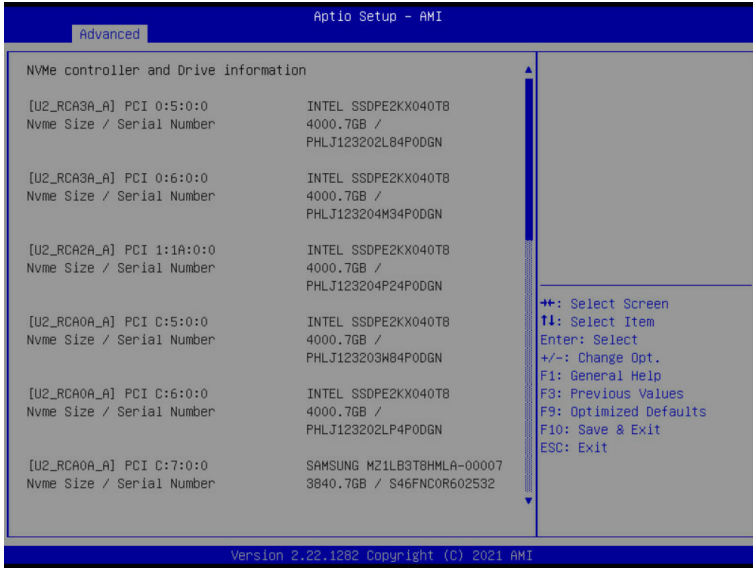

Parameter	Description
NVMe controller and Drive information	Displays the NVMe devices connected to the system

5-2-12 Graphic Output Configuration

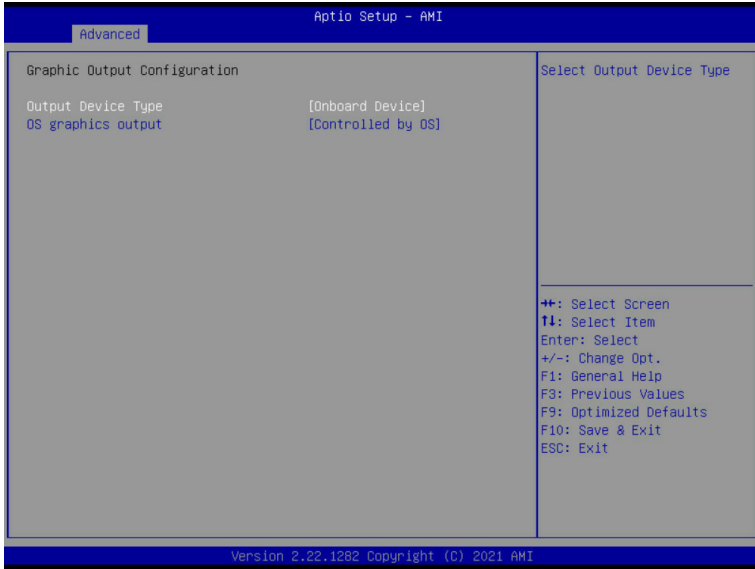

Parameter	Description
Graphic Output Configuration	
Output Device Type	Selects output device type. Options available: First loaded Device, Onboard Device, External Device, Specific Device. Default setting is Onboard Device .
OS graphics output	Use Onboard graphics output under OS (BMC KVM requires onboard graphics output). Options available: Controlled by OS, Onboard VGA. Default setting is Onboard Device .

5-2-13 Power Restore Configuration

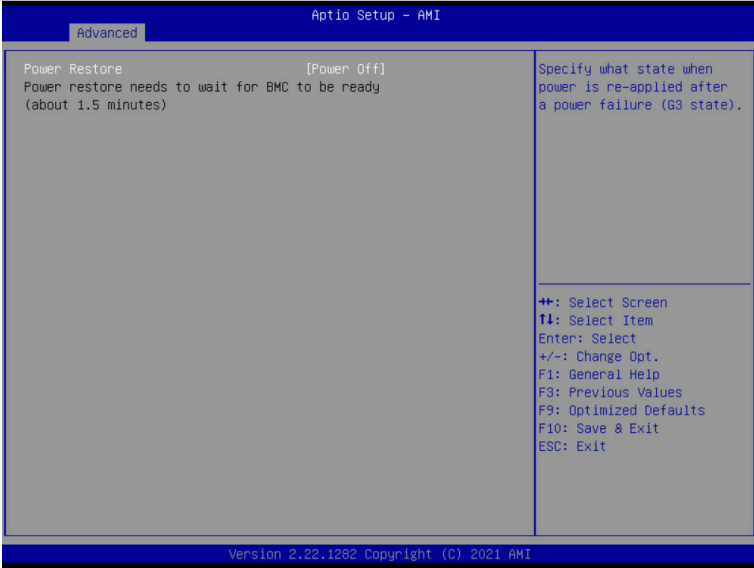

Parameter	Description
Power Restore	Specifies what state when power is re-applied after a power failure (G3 state). Options available: Power Off, Power On, Last State. Default setting is Power Off .

5-2-14 Tls Auth Configuration

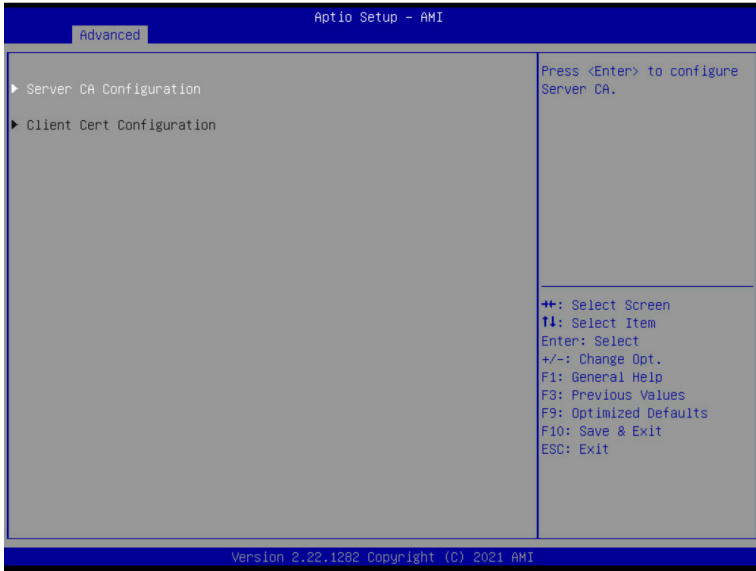

Parameter	Description
Server CA Configuration	<p>Press [Enter] for configuration of advanced items.</p> <ul style="list-style-type: none"> ◆ Enroll Cert <ul style="list-style-type: none"> – Press [Enter] to enroll a certificate <ul style="list-style-type: none"> • Enroll Cert Using File • Cert GUID <ul style="list-style-type: none"> Input digit character in 1111111-2222-3333-4444-1234567890ab format. – Commit Changes and Exit – Discard Changes and Exit ◆ Delete Cert
Client Cert Configuration	Press [Enter] for configuration of advanced items.

5-2-15 Intel(R) I350 Gigabit Network Connection

Advanced		Aptio Setup - AMI
<p>▶ NIC Configuration</p> <p>Blink LEDs 0</p> <p>UEFI Driver Intel(R) PRO/1000 Open Source 9.2.06 PCI-E</p> <p>Adapter PBA 140422-008</p> <p>Device Name Intel(R) I350 Gigabit Network Connection</p> <p>Chip Type Intel i350</p> <p>PCI Device ID 1521</p> <p>PCI Address 02:00:00</p> <p>Link Status [Connected]</p> <p>MAC Address D8:5E:D3:00:05:F7</p> <p>Virtual MAC Address 00:00:00:00:00:00</p>		<p>Click to configure the network device port.</p> <hr/> <p> ++: Select Screen ↑↓: Select Item Enter: Select +/-: Change Opt. F1: General Help F3: Previous Values F9: Optimized Defaults F10: Save & Exit ESC: Exit </p>
Version 2.22.1282 Copyright (C) 2021 AMI		

Advanced		Aptio Setup - AMI
<p>Link Speed [Auto Negotiated]</p> <p>Wake On LAN [Enabled]</p>		<p>Specifies the port speed used for the selected boot protocol.</p> <hr/> <p> ++: Select Screen ↑↓: Select Item Enter: Select +/-: Change Opt. F1: General Help F3: Previous Values F9: Optimized Defaults F10: Save & Exit ESC: Exit </p>
Version 2.22.1282 Copyright (C) 2021 AMI		

Parameter	Description
NIC Configuration	<p>Press [Enter] to configure advanced items.</p> <ul style="list-style-type: none"> ◆ Link Speed <ul style="list-style-type: none"> – Allows for automatic link speed adjustment. – Options available: Auto Negotiated, 10 Mbps Half, 10 Mbps Full, 100 Mbps Half, 100 Mbps Full. Default setting is Auto Negotiated. ◆ Wake On LAN <ul style="list-style-type: none"> – Enables power on of the system via LAN. Note that configuring Wake on LAN in the operating system does not change the value of this setting, but does override the behavior of Wake on LAN in OS controlled power states. – Options available: Enabled, Disabled. Default setting is Enabled.
Blink LEDs	<p>Identifies the physical network port by blinking the associated LED. Press the numeric keys to adjust desired values (up to 15 seconds).</p>
UEFI Driver	Displays the technical specifications for the Network Interface Controller.
Adapter PBA	Displays the technical specifications for the Network Interface Controller.
Device Name	Displays the technical specifications for the Network Interface Controller.
Chip Type	Displays the technical specifications for the Network Interface Controller.
PCI Device ID	Displays the technical specifications for the Network Interface Controller.
PCI Address	Displays the technical specifications for the Network Interface Controller.
Link Status	Displays the technical specifications for the Network Interface Controller.
MAC Address	Displays the technical specifications for the Network Interface Controller.
Virtual MAC Address	Displays the technical specifications for the Network Interface Controller.

5-2-16 Mellanox Network Adapter

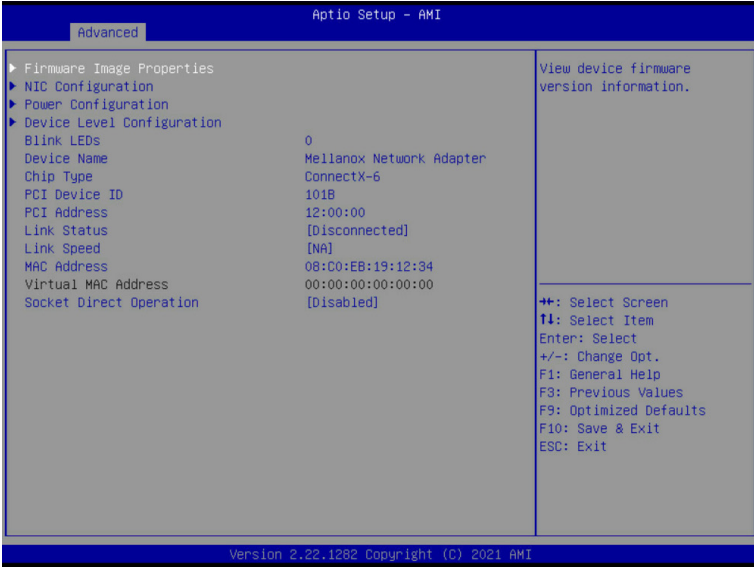

Parameter	Description
Firmware Image Properties	Press [Enter] to view the firmware version information of installed device.
NIC Configuration	Press [Enter] to configure advanced items. <ul style="list-style-type: none"> ◆ PKey <ul style="list-style-type: none"> – Pkey ID to be used by PXE boot. Enter a number in range 0-65535.
Power Configuration	Press [Enter] to configure advanced items. <ul style="list-style-type: none"> ◆ Advanced power settings <ul style="list-style-type: none"> – Options available: Disabled, Enabled. Default setting is Enabled. ◆ Slot power limiter <ul style="list-style-type: none"> – Options available: Disabled, Enabled. Default setting is Disabled.
Device Level Configuration	Press [Enter] to configure advanced items. <ul style="list-style-type: none"> ◆ Virtualization Mode <ul style="list-style-type: none"> – Options available: None, SR-IOV. Default setting is None. ◆ PCI Virtual Functions Advertised <ul style="list-style-type: none"> – This item is configurable when the virtualization mode is set to "SR-IOV". – Configure the number of virtual functions supported on this device.
Blink LEDs	Identifies the physical network port by blinking the associated LED. Press the numeric keys to adjust desired values (up to 15 seconds).
Device Name	Displays the technical specifications for the Network Adapter.

(Note) This section appears when the network adapter has been installed.

Chip Type	Displays the technical specifications for the Network Adapter.
PCI Device ID	Displays the technical specifications for the Network Adapter.
PCI Address	Displays the technical specifications for the Network Adapter.
Link Status	Displays the technical specifications for the Network Adapter.
Link Speed	Displays the technical specifications for the Network Adapter.
MAC Address	Displays the technical specifications for the Network Adapter.
Virtual MAC Address	Displays the technical specifications for the Network Adapter.
Socket Direct Operation	Default setting is Disabled .

5-2-17 MAC IPv6 Network Configuration

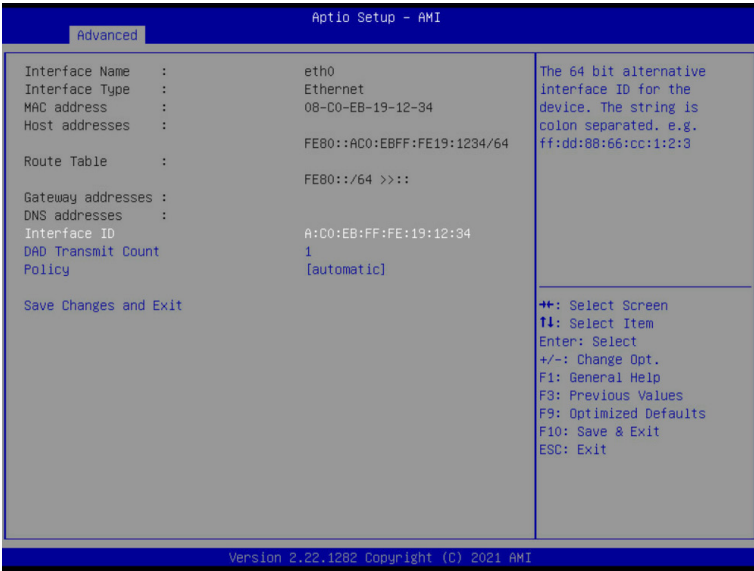

Parameter	Description
Enter Configuration Menu	<p>Press [Enter] to configure advanced items.</p> <ul style="list-style-type: none"> ◆ Displays the MAC Address information. ◆ Interface ID <ul style="list-style-type: none"> – The 64 bit alternative interface ID for the device. The string is colon separated. e.g. ff:dd:88:66:cc:1:2:3. ◆ DAD Transmit Count <ul style="list-style-type: none"> – The number of consecutive Neighbor solicitation messages sent while performing Duplicate Address Detection on a tentative address. A value of zero indicates that Duplicate Address Detection is not performed. ◆ Policy <ul style="list-style-type: none"> – Options available: automatic, manual. Default setting is automatic. ◆ Save Changes and Exit <ul style="list-style-type: none"> – Press [Enter] to save all configurations.

5-2-18 MAC IPv4 Network Configuration

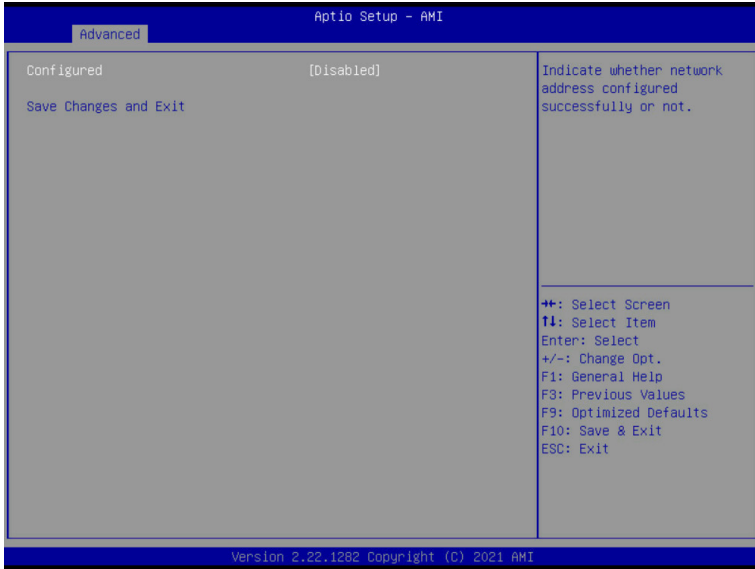

Parameter	Description
Configured	Indicates whether network address is configured successfully or not. Options available: Enabled, Disabled. Default setting is Disabled .
Enable DHCP ^(Note)	Options available: Enabled, Disabled. Default setting is Enabled .
Local IP Address ^(Note)	Press [Enter] to configure local IP address.
Local NetMask ^(Note)	Press [Enter] to configure local NetMask.
Local Gateway ^(Note)	Press [Enter] to configure local Gateway
Local DNS Servers ^(Note)	Press [Enter] to configure local DNS servers
Save Changes and Exit	Press [Enter] to save all configurations.

(Note) This item appears when **Configured** is set to **Enabled**.

5-3 Chipset Setup Menu

Chipset Setup menu displays submenu options for configuring the function of North Bridge. Select a submenu item, then press <Enter> to access the related submenu screen.

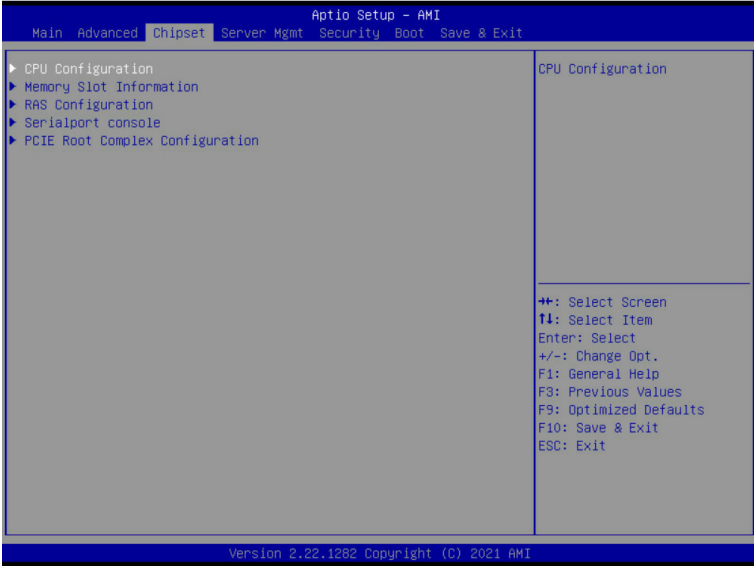

Parameter	Description
CPU Configuration	Press [Enter] for configuration of advanced items.
Memory Slot Information	Press [Enter] for configuration of advanced items.
RAS Configuration	Press [Enter] for configuration of advanced items.
Serialport console	Press [Enter] for configuration of advanced items.
PCIE Root Complex Configuration	Press [Enter] for configuration of advanced items.

5-3-1 CPU Configuration

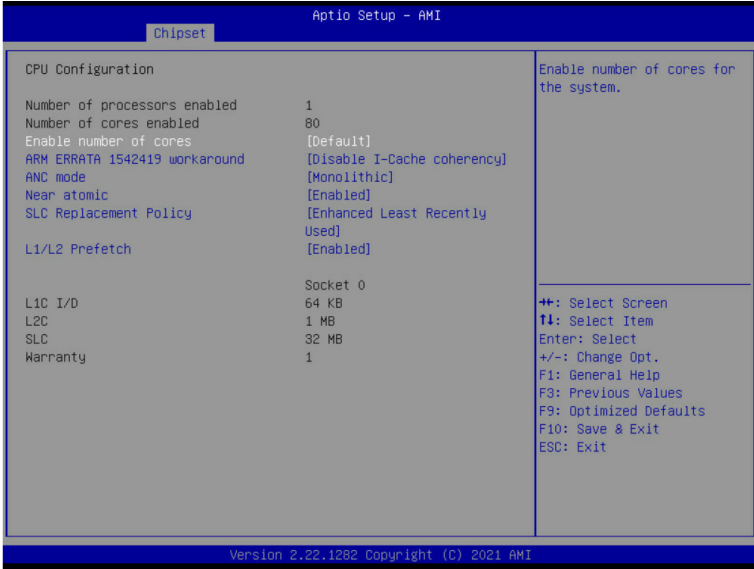

Parameter	Description
CPU Configuration	
Number of processors/cores enabled	Displays the number of installed processor information.
Enable number of cores	Enable number of cores for the system. Default setting is Default .
ARM ERRATA 1542419 workaround	Options available: Disable I-Cache coherency, Software solution, Disable. Default setting is Disable I-Cache coherency .
ANC mode	Options available: Monolithic, Hemisphere, Quadrant. Default setting is Monolithic .
Near atomic	Enable/Disable cacheable atomic instruction executed near in CPU. Options available: Enabled, Disabled. Default setting is Enabled .
SLC Replacement Policy	Options available: Enhanced Least Recently Used, Linear-Feedback Shift Register. Default setting is Enhanced Least Recently Used .
L1/L2 Prefetch	Enable/Disable L1/L2 Prefetch for each core. Options available: Enabled, Disabled. Default setting is Enabled .
L1C I/D	Displays the technical specifications for the installed processor
L2C	
SLC	
Warrenty	

5-3-2 Memory Slot Information

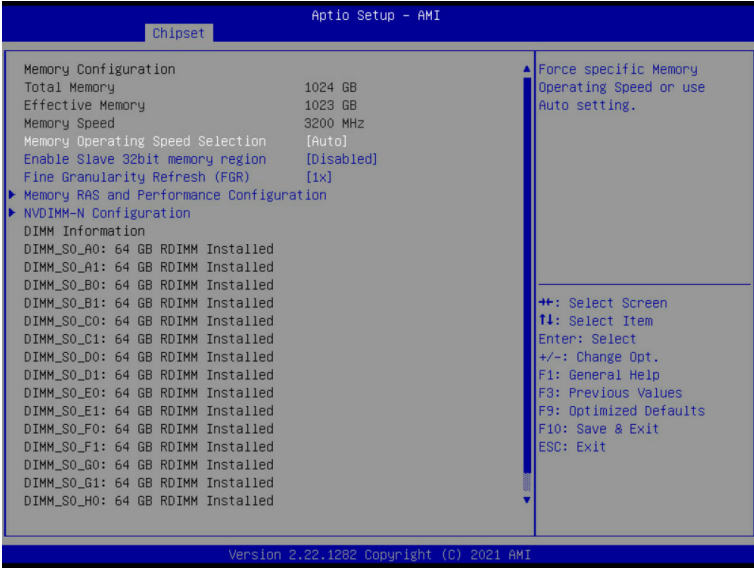

Parameter	Description
Memory Configuration	
Total Memory/ Effective Memory/ Memory Speed	Displays the technical specifications for the installed memory module.
Memory Operating Speed Selection	Options available: Auto, 2133, 2400, 2666, 2933, 3200. Default setting is Auto .
Enable Slave 32bit memory region	Options available: Disabled, Enabled. Default setting is Disabled .
Fine Granularity Refresh (FGR)	Options available: 1x, 2x, 4x. Default setting is 1x .
Memory RAS and Performance Configuration	<p>Press [Enter] to configure advanced items.</p> <ul style="list-style-type: none"> ◆ ECC mode <ul style="list-style-type: none"> – Options available: Auto, Disabled, SECCDED, Symbol. Default setting is Auto. ◆ Defer uncorrectable read errors <ul style="list-style-type: none"> – Options available: Disabled, Enabled. Default setting is Enabled. ◆ Fault handling interrupt <ul style="list-style-type: none"> – Options available: Disabled, Enabled. Default setting is Enabled. ◆ Scrub Patrol duration (hour) <ul style="list-style-type: none"> – Options available: Disabled, 1,..., 24. Default setting is 24.

Parameter	Description
Memory RAS and Performance Configuration (continued)	<ul style="list-style-type: none"> ◆ Demand scrub <ul style="list-style-type: none"> – Options available: Disabled, Enabled. Default setting is Enabled. ◆ Write CRC <ul style="list-style-type: none"> – Options available: Disabled, Enabled. Default setting is Disabled. ◆ CVE-2020-10255 mitigation <ul style="list-style-type: none"> – Options available: Disabled, Enabled. Default setting is Disabled.
NVDIMM-N Configuration	<p>Press [Enter] to configure advanced items.</p> <ul style="list-style-type: none"> ◆ Socket0 Configured Mode ◆ Mode Selection <ul style="list-style-type: none"> – Options available: Non-NVDIMM, Non-Hashed, Hashed, Auto. Default setting is Auto.
DIMM Information	Displays installed DIMM information.

5-3-3 RAS Configuration

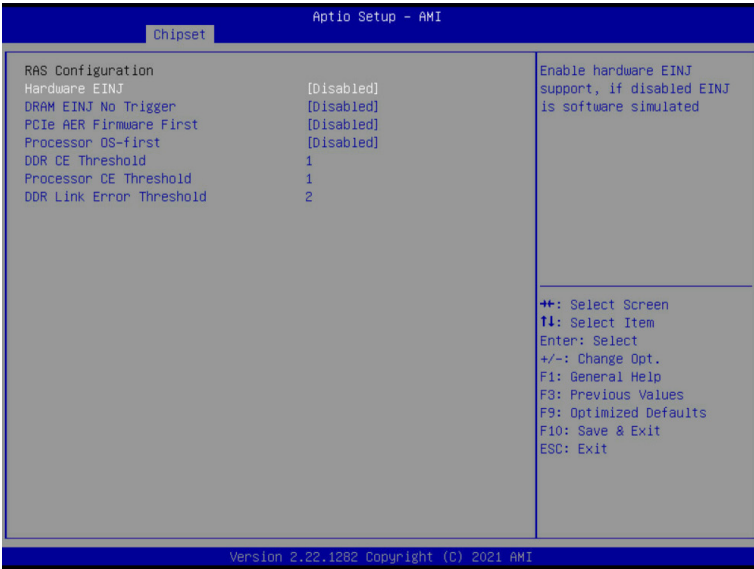

Parameter	Description
RAS Configuration	
Hardware EINJ	Options available: Disabled, Enabled. Default setting is Disabled .
DRAM EINJ No Trigger	Options available: Disabled, Enabled. Default setting is Disabled .
PCIe AER Firmware First	Options available: Disabled, Enabled. Default setting is Disabled .
Processor OS-first	Options available: Disabled, Enabled. Default setting is Disabled .
DDR CE Threshold	Press "+" or "-" to configure the threshold.
Processor CE Threshold	Press "+" or "-" to configure the threshold.
DDR Link Error Threshold	Press "+" or "-" to configure the threshold.

5-3-4 Serialport console

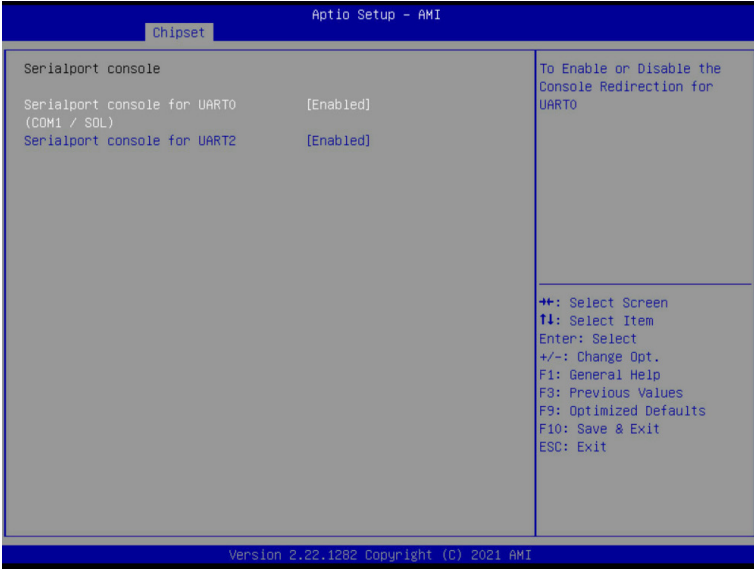

Parameter	Description
Serialport console	
Serialport console for UART0 (COM1/SOL)	Options available: Disabled, Enabled. Default setting is Enabled .
Serialport console for UART2	Options available: Disabled, Enabled. Default setting is Enabled .

5-3-5 PCIe Root Complex Configuration

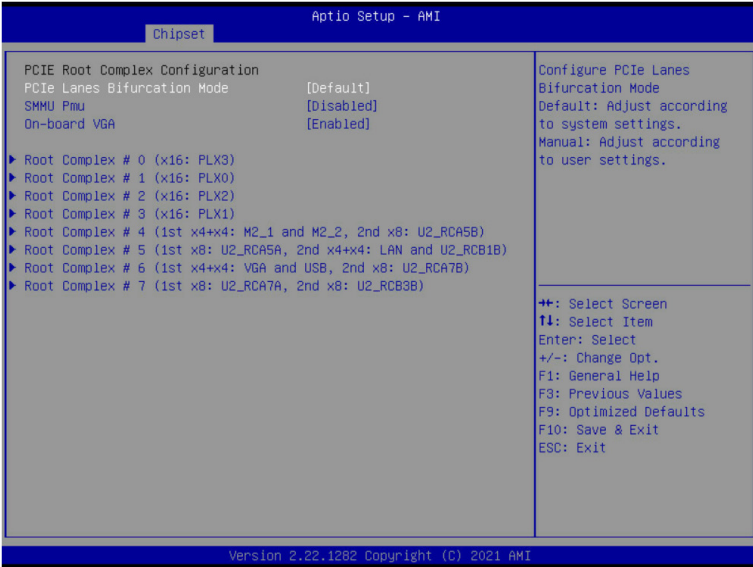

Parameter	Description
PCIe Root Complex Configuration	
PCIe Lanes Bifurcation Mode	Options available: Manual, Default. Default setting is Default .
SMMU Pmu	Options available: Disabled, Enabled. Default setting is Disabled .
On-board VGA	Options available: Disabled, Enabled. Default setting is Enabled .
Root Complex # ^(Note)	Press [Enter] to view advanced items.

(Note) This item is configurable when **PCIe Lanes Bifurcation Mode** is set to **Manual**.

5-4 Server Management Menu

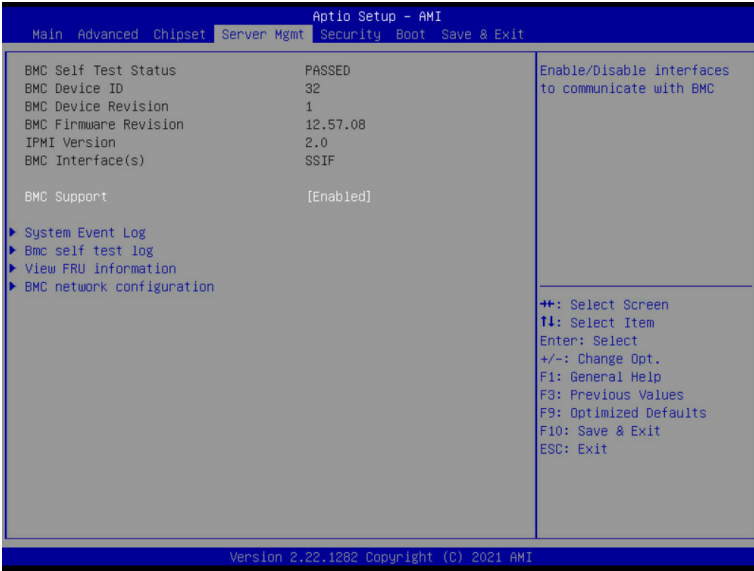

Parameter	Description
BMC Self Test Status/ BMC Device ID/ BMC Device Revision/ BMC Firmware Revision/ IPMI Version/ BMC Interface(s)	Displays the technical specification of the BMC controller.
BMC Support	Options available: Enabled, Disabled. Default setting is Enabled .
System Event Log	Press [Enter] to configure advanced items.
Bmc self test log	Press [Enter] to configure advanced items.
View FRU Information	Press [Enter] to view the FRU information.
BMC network configuration	Press [Enter] to configure advanced items.

5-4-1 System Event Log

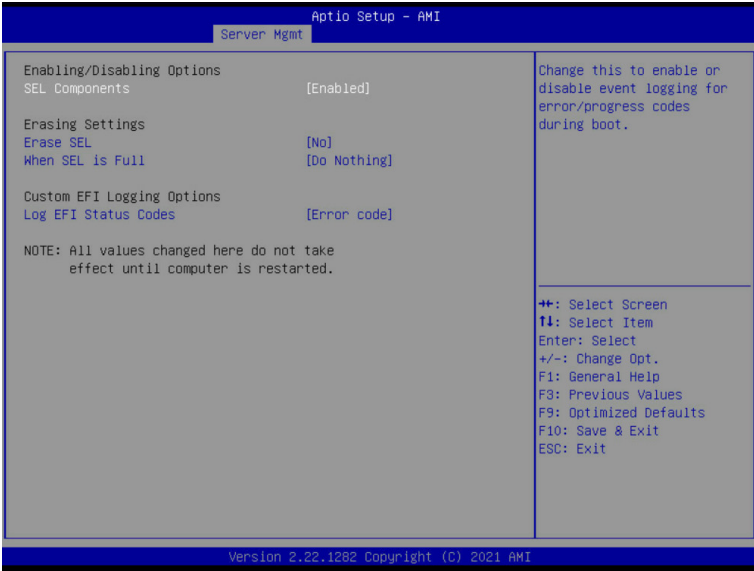

Parameter	Description
Enabling / Disabling Options	
SEL Components	Change this item to enable or disable all features of System Event Logging during boot. Options available: Enabled, Disabled. Default setting is Enabled .
Erasing Settings	
Erase SEL	Choose options for erasing SEL. Options available: No/Yes, On next reset/Yes, On every reset. Default setting is No .
When SEL is Full	Choose options for reactions to a full SEL. Options available: Do Nothing, Erase Immediately, Delete Oldest Record. Default setting is Do Nothing .
Custom EFI Logging Options	
Log EFI Status Codes	Enable/Disable the logging of EFI Status Codes (if not already converted to legacy). Options available: Disabled, Both, Error code, Progress code. Default setting is Error code .

5-4-2 Bmc self test log

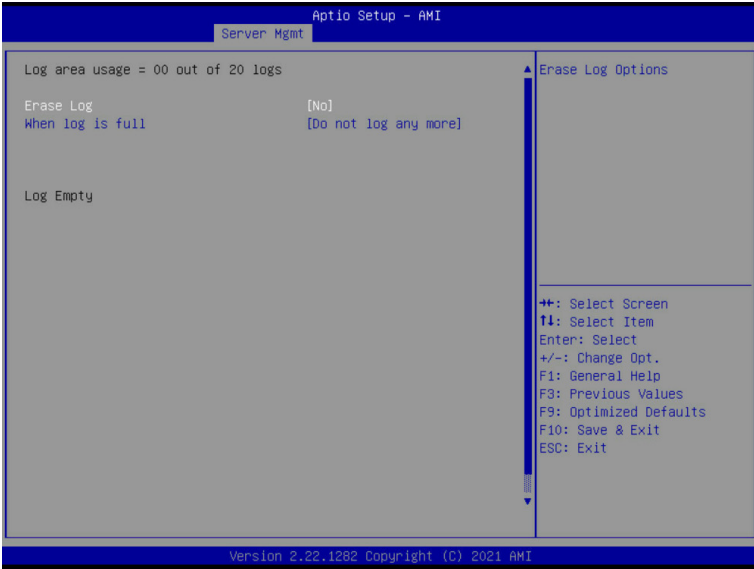

Parameter	Description
Log area usage = 00 out of 20 logs	
Erase Log	Options available: Yes, On every reset/ No. Default setting is No .
When log is full	Options available: Clear Log, Do not log any more. Default setting is Do not log any more .

5-4-3 View FRU Information

The FRU page is a simple display page for basic system ID information, as well as System product information. Items on this window are non-configurable.

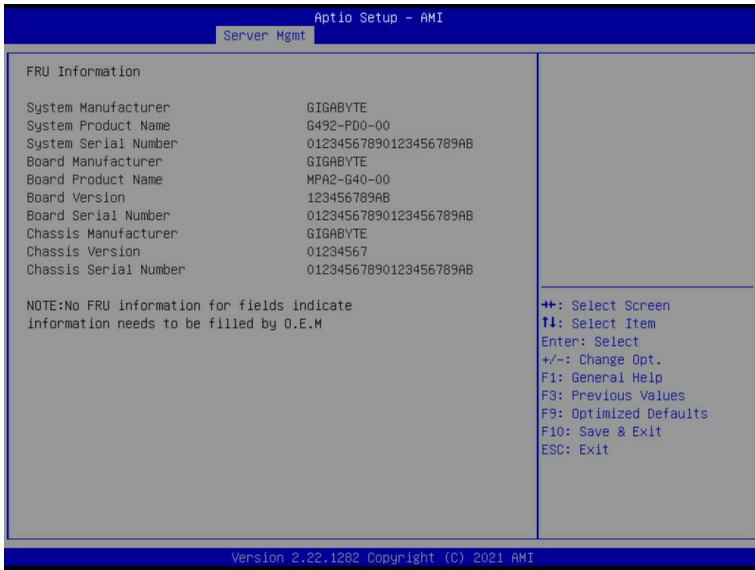

(Note) The model name will vary depends on the product you purchased

5-4-4 BMC Network Configuration

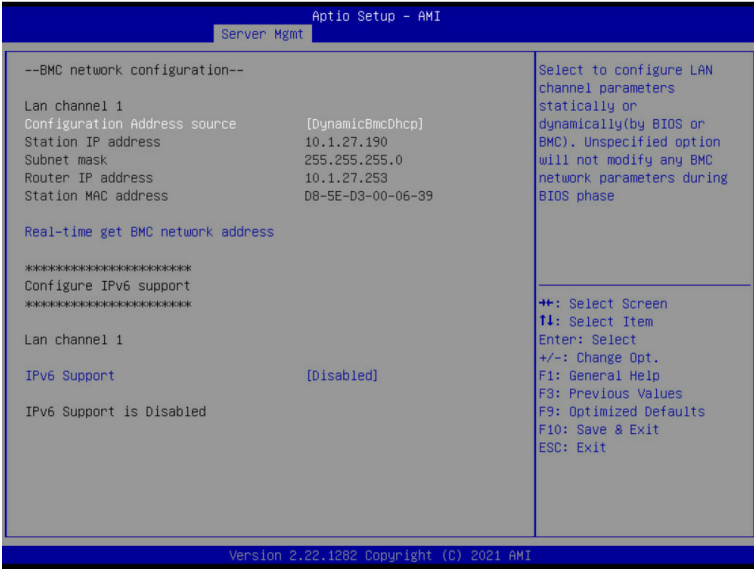

Parameter	Description
BMC network configuration	
Lan Channel 1	
Configuration Address source	Selects to configure LAN channel parameters statically or dynamically (DHCP). Do nothing option will not modify any BMC network parameters during BIOS phase. Options available: Unspecified, Static, DynamicBmcDhcp. Default setting is DynamicBmcDhcp .
Station IP address	Displays IP Address information.
Subnet mask	Displays Subnet Mask information. Please note that the IP address must be in three digitals, for example, 192.168.000.001.
Router IP address	Displays the Router IP Address information.
Station MAC address	Displays the MAC Address information.
Real-time synchronize BMC network parameter values	Press [Enter] will set Address source(Static/DHCP) to BMC and then get Station IP address, Subnet mask and Router IP address from BMC.
IPv6 Support	Options available: Enabled, Disabled. Default setting is Disabled .

5-5 Security Menu

The Security menu allows you to safeguard and protect the system from unauthorized use by setting up access passwords.

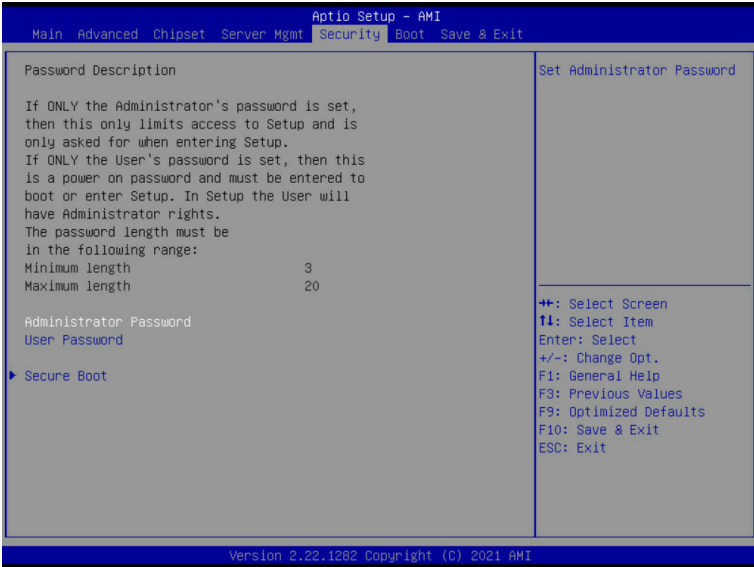

There are two types of passwords that you can set:

- Administrator Password
Entering this password will allow the user to access and change all settings in the Setup Utility.
- User Password
Entering this password will restrict a user's access to the Setup menus. To enable or disable this field, a Administrator Password must first be set. A user can only access and modify the System Time, System Date, and Set User Password fields.

Parameter	Description
Administrator Password	Press [Enter] to configure the administrator password.
User Password	Press [Enter] to configure the user password.
Secure Boot	Press [Enter] to configure advanced items.

5-5-1 Secure Boot

The Secure Boot submenu is applicable when your device is installed the Windows® 8 (or above) operating system.



Parameter	Description
System Mode	Displays if the system is in User mode or Setup mode.
Secure Boot	Enable/ Disable the Secure Boot function. Options available: Enabled, Disabled. Default setting is Disabled .
Secure Boot Mode ^(Note)	Secure Boot requires all the applications that are running during the booting process to be pre-signed with valid digital certificates. This way, the system knows all files being loaded before Windows loads to the login screen have not been tampered with. When set to Standard, it will automatically load the Secure Boot keys from the BIOS databases. When set to Custom, you can customize the Secure Boot settings and manually load its keys from the BIOS database. Options available: Standard, Custom. Default setting is Standard .
Restore Factory Keys	Forces the system to user mode and installs factory default Secure Boot key database.
Reset To Setup Mode	Press [Enter] to reset the system mode to Setup mode.

(Note) Advanced items prompt when this item is set to **Custom**.

Parameter	Description
Key Management	<p data-bbox="335 156 665 180">Press [Enter] to configure advanced items.</p> <p data-bbox="335 185 941 235">Please note that this item is configurable when Secure Boot Mode is set to Custom.</p> <ul style="list-style-type: none"> <li data-bbox="335 243 946 352">◆ Factory Key Provision <ul style="list-style-type: none"> <li data-bbox="367 266 946 321">– Allows to provision factory default Secure Boot keys when system is in Setup Mode. <li data-bbox="367 326 899 352">– Options available: Enabled, Disabled. Default setting is Disabled. <li data-bbox="335 357 931 431">◆ Restore Factory Keys <ul style="list-style-type: none"> <li data-bbox="367 381 931 404">– Installs all factory default keys. It will force the system in User Mode. <li data-bbox="367 409 606 431">– Options available: Yes, No. <li data-bbox="335 435 707 486">◆ Reset to Setup Mode <ul style="list-style-type: none"> <li data-bbox="367 459 707 486">– Reset the system mode to Setup mode. <li data-bbox="335 490 760 540">◆ Export Secure Boot variables <ul style="list-style-type: none"> <li data-bbox="367 514 760 540">– Export all Secure Boot Keys and key variables. <li data-bbox="335 545 904 627">◆ Enroll Efi Image <ul style="list-style-type: none"> <li data-bbox="367 569 904 627">– Press [Enter] to enroll SHA256 hash of the binary into Authorized Signature Database (db). <li data-bbox="335 631 702 682">◆ Restore DB defaults <ul style="list-style-type: none"> <li data-bbox="367 655 702 682">– Restore DB variable to factory defaults. <li data-bbox="335 686 899 736">◆ Secure Boot variable <ul style="list-style-type: none"> <li data-bbox="367 710 899 736">– Displays the current status of the variables used for secure boot. <li data-bbox="335 741 803 846">◆ Platform Key (PK) <ul style="list-style-type: none"> <li data-bbox="367 765 803 791">– Displays the current status of the Platform Key (PK). <li data-bbox="367 796 680 823">– Press [Enter] to configure a new PK. <li data-bbox="367 827 601 846">– Options available: Update. <li data-bbox="335 851 946 987">◆ Key Exchange Keys (KEK) <ul style="list-style-type: none"> <li data-bbox="367 874 946 901">– Displays the current status of the Key Exchange Key Database (KEK). <li data-bbox="367 906 909 956">– Press [Enter] to configure a new KEK or load additional KEK from storage devices. <li data-bbox="367 961 670 987">– Options available: Update, Append. <li data-bbox="335 992 946 1128">◆ Authorized Signatures (DB) <ul style="list-style-type: none"> <li data-bbox="367 1016 909 1042">– Displays the current status of the Authorized Signature Database. <li data-bbox="367 1047 946 1097">– Press [Enter] to configure a new DB or load additional DB from storage devices. <li data-bbox="367 1102 670 1128">– Options available: Update, Append. <li data-bbox="335 1133 904 1270">◆ Forbidden Signatures (DBX) <ul style="list-style-type: none"> <li data-bbox="367 1157 904 1183">– Displays the current status of the Forbidden Signature Database. <li data-bbox="367 1188 893 1238">– Press [Enter] to configure a new dbx or load additional dbx from storage devices. <li data-bbox="367 1243 670 1270">– Options available: Update, Append. <li data-bbox="335 1274 931 1411">◆ Authorized TimeStamps (DBT) <ul style="list-style-type: none"> <li data-bbox="367 1298 931 1324">– Displays the current status of the Authorized TimeStamps Database. <li data-bbox="367 1329 909 1379">– Press [Enter] to configure a new DBT or load additional DBT from storage devices. <li data-bbox="367 1384 670 1411">– Options available: Update, Append.

Parameter	Description
Key Management (continued)	<ul style="list-style-type: none">◆ OsRecovery Signatures<ul style="list-style-type: none">– Displays the current status of the OsRecovery Signature Database.– Press [Enter] to configure a new OsRecovery Signature or load additional OsRecovery Signature from storage devices.– Options available: Update, Append.

5-6 Boot Menu

The Boot menu allows you to set the drive priority during system boot-up. BIOS setup will display an error message if the legacy drive(s) specified is not bootable.

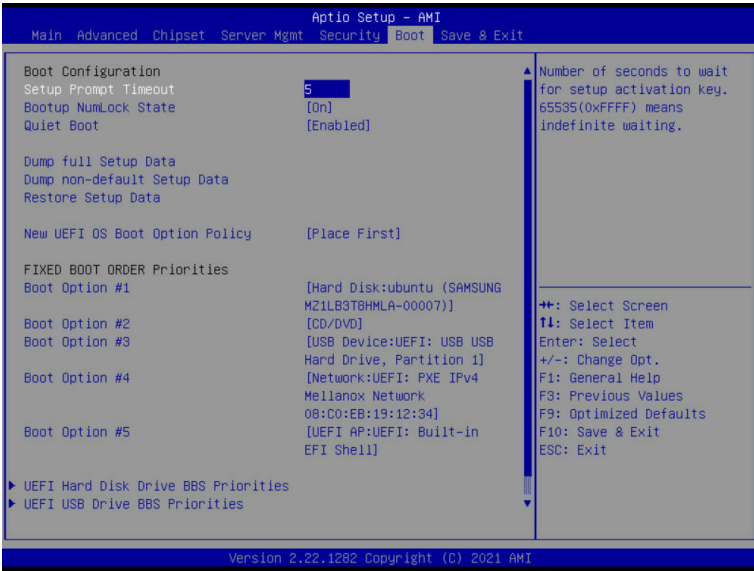

Parameter	Description
Boot Configuration	
Setup Prompt Timeout	Number of seconds to wait for setup activation key. 65535 (0xFFFF) means indefinite waiting. Press the numeric keys to input the desired values.
Bootup NumLock State	Enable/Disable the Bootup NumLock function. Options available: On, Off. Default setting is On .
Quiet Boot	Enable/Disable showing the logo during POST. Options available: Enabled, Disabled. Default setting is Enabled .
Dump full Setup Data	Press [Enter] to dump full setup data to file.
Dump non-default Setup Data	Press [Enter] to dump non-default setup data to file.
Restore Setup Data	Press [Enter] to restore setup data from file (cJson format).
New UEFI OS Boot Option Policy	Controls the placement of newly detected UEFI boot options. Options available: Default, Place First, Place Last. Default setting is Place First .

Parameter	Description
FIXED BOOT ORDER Priorities	
Boot Option #1 / #2 / #3 / #4 / #5	<p>Press [Enter] to configure the boot priority. By default, the server searches for boot devices in the following sequence:</p> <ol style="list-style-type: none"> 1. Hard drive. 2. CD-COM/DVD drive. 3. USB device. 4. Network. 5. UEFI.
UEFI Network Drive BBS Priorities	Press [Enter] to configure the boot priority.
UEFI Application Boot Priorities	Press [Enter] to configure the boot priority.

5-7 Save & Exit Menu

The Save & Exit menu displays the various options to quit from the BIOS setup. Highlight any of the exit options then press <Enter>.

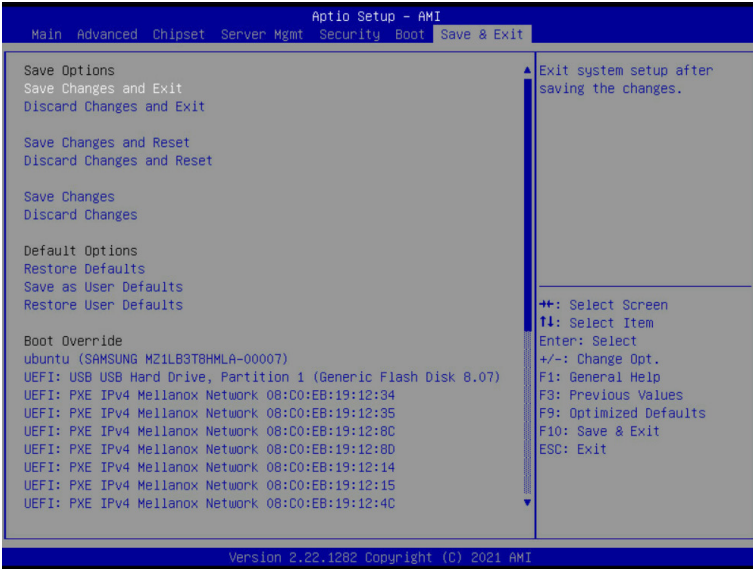

Parameter	Description
Save Options	
Save Changes and Exit	Saves changes made and closes the BIOS setup. Options available: Yes, No.
Discard Changes and Exit	Discards changes made and exits the BIOS setup. Options available: Yes, No.
Save Changes and Reset	Restarts the system after saving the changes made. Options available: Yes, No.
Discard Changes and Reset	Restarts the system without saving the changes made. Options available: Yes, No.
Save Changes	Saves changes done so far to any of the setup options. Options available: Yes, No.
Default Options	
Restore Defaults	Loads the default settings for all BIOS setup parameters. Setup Defaults are quite demanding in terms of resources consumption. If you are using low-speed memory chips or other kinds of low-performance components and you choose to load these settings, the system might not function properly. Options available: Yes, No.

Parameter	Description
Save as User Defaults	Press [Enter] to save changes as the user defaults without exit BIOS setup.
Restore User Defaults	Press [Enter] to restore the user defaults .
Boot Override	Press [Enter] to configure the device as the boot-up drive.
Launch EFI Shell from filesystem device	Attempts to Launch EFI Shell application (Shell.efi) from one of the available file system devices.

5-8 BIOS POST Beep code (AMI standard)

5-8-1 PEI Beep Codes

# of Beeps	Description
1	Memory not Installed.
1	Memory was installed twice (InstallPeiMemory routine in PEI Core called twice)
2	Recovery started
3	DXE IPL was not found
3	DXE Core Firmware Volume was not found
4	Recovery failed
4	S3 Resume failed
7	Reset PPI is not available

5-8-2 DXE Beep Codes

# of Beeps	Description
1	Invalid password
4	Some of the Architectural Protocols are not available
5	No Console Output Devices are found
5	No Console Input Devices are found
6	Flash update is failed
7	Reset protocol is not available
8	Platform PCI resource requirements cannot be met