



Quick Installation Guide

For Network Attached Storage

Table of Contents

Notices	3
Safety Precautions	4
1. Package Contents	5
2. Optional Accessories	6
3. Hardware Installation Guide.....	7
3.1. Hard Disk Installation.....	7
3.2. Connecting and Powering on the NAS.....	9
3.3. Upgrading System Memory	9
3.3.1 Notes and Precautions.....	9
3.3.2 Parts and Tools Needed	10
3.3.3 Removing the Cover	11
3.3.4 Installing Memory.....	12
3.3.5 Replacing the Cover.....	13
4. Software Installation Guide.....	14
4.1. CD Installation	14
4.1.1. Windows Users	14
4.1.2. Mac Users	14
4.2. Web Installation	16
4.3. Installation Using the LCD Display.....	16
4.4. Installation Using a Direct Connection	16
5. Appendix	17
5.1. LED Indicators	17
5.2. Rear Panel.....	18
5.3. Rating Label	18
5.4. Troubleshooting	18

Notices

Federal Communications Commission Statement



This device complies with FCC Rules Part 15. Operation is subject to the following two conditions:

- This device may not cause harmful interference.
- This device must accept any interference received, including interference that may cause undesired operation.

This equipment has been tested and found to comply with the limits for a class B digital device, pursuant to Part 15 of the Federal Communications Commission (FCC) rules. These limits are designed to provide reasonable protection against harmful interference in a residential installation. This equipment generates, uses, and can radiate radio frequency energy and, if not installed and used in accordance with the instructions, may cause harmful interference to radio communications. However, there is no guarantee that interference will not occur in a particular installation. If this equipment does cause harmful interference to radio or television reception, which can be determined by turning the equipment off and on, the user is encouraged to try to correct the interference by one or more of the following measures:

- Reorient or relocate the receiving antenna.
- Increase the separation between the equipment and receiver.
- Connect the equipment into an outlet on a circuit different from that to which the receiver is connected.
- Consult the dealer or an experienced radio/TV technician for help.

Changes or modifications not expressly approved by the party responsible for compliance could void the user's authority to operate the equipment.

CE Mark Warning



CE marking for devices without wireless LAN/Bluetooth

The shipped version of this device complies with the requirements of the EEC directives 2004/108/EC "Electromagnetic compatibility" and IEC60950-1:2005 (2nd Edition)+A1:2009 "Information technology equipment-Safety".



The Adopted Trademarks HDMI, HDMI High-Definition Multimedia Interface, HDMI trade dress and the HDMI Logos are trademarks or registered trademarks of HDMI Licensing Administrator, Inc. in the United States and other countries.

Safety Precautions

The following safety precautions will increase the life of the NAS. Follow all precautions and instructions.

Electrical safety

- Unplug this product from the power source before cleaning.
- Use only the bundled power adapter. Using other power adapters may damage your device.
- Ensure that you plug the power adapter to the correct power input rating. Check the label on the power adapter for the power rating.

Operation safety

- DO NOT place this product in a location where it may get wet.
- Place this product on a flat and stable surface.
- Use this product in environments with an ambient temperature between 5°C and 35°C.
- DO NOT block the air vents on the case of this product. Always provide proper ventilation for this product.
- DO NOT insert any object or spill liquid into the air vents. If you encounter technical problems with this product, contact a qualified service technician or your retailer. DO NOT attempt to repair this product yourself.













DO NOT throw this product in municipal waste. This product has been designed to enable proper reuse of parts and recycling. This symbol of the crossed out wheeled bin indicates that the product (electrical and electronic equipment) should not be placed in municipal waste. Check local regulations for disposal of electronic products.



1. Package Contents

Applicable Models: AS-602T, AS-604T, AS-606T and AS-608T

Contents	AS-602T	AS-604T	AS-606T	AS-608T
NAS device				
Power cord	1	1	1	1
				
Adapter	1	N/A	N/A	N/A
				
RJ45 network cable	2	2	2	2
				
Screws for use with 3.5" HDD	8	16	24	32
				
Screws for use with 2.5" HDD	8	16	24	32
				
Installation CD	1	1	1	1
				
Quick Start Guide	1	1	1	1
				

2. Optional Accessories

The items below may be purchased from the ASUSTOR Accessories Store (<http://shop.asustor.com>). Other items such as HDMI cables (2M recommended), wireless RF keyboards, mice and remote controls along with Bluetooth keyboards and mice are purchased separately.

AS-RC10	AS-RAM1G	AS-RAM2G
 <p>10 Key IR Remote Control</p>	 <p>1GB DDR3-1333 204Pin SO-DIMM RAM Module</p>	 <p>2GB DDR3-1333 204Pin SO-DIMM RAM Module</p>
AS-250W	AS-150W	AS-60W
 <p>250W Flex Power Supply</p>	 <p>150W Flex Power Supply</p>	 <p>60W Power Adaptor</p>
AS-Tray	AS-Rail	AS-IR
 <p>Black HDD tray for 2.5 & 3.5-inch HDD</p>	 <p>Rail kit for 1U/2U Rack-Mounted System</p>	 <p>USB IR Receiver for AS-6</p>
AS-RCU		
 <p>IR Remote Control with USB IR Receiver for AS-6</p>		

3. Hardware Installation Guide

All data stored on the hard disk(s) will be erased and CANNOT be recovered. Please back up all important data before initializing the system.

3.1. Hard Disk Installation

- Press the button on the lower portion of the hard disk tray to release the latch.

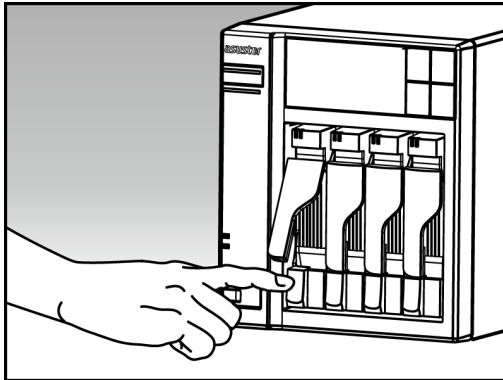

- Using the latch, gently pull the disk tray out of the disk bay.

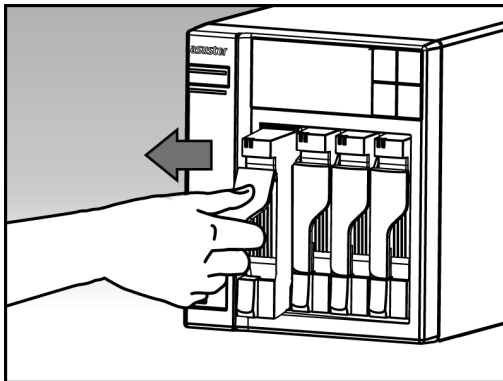

- Mount the hard disk to the disk tray
 - **3.5-inch hard disks:** Place the hard disk into the disk tray, making sure that the mounting holes on the sides of the hard disk and disk tray are lined up. Secure the drive with four screws.

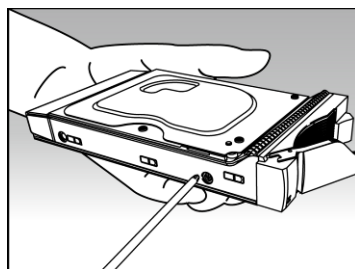

- **2.5-inch hard disks and SSD hard disks:** Place the hard disk into the area of the disk tray outlined in red (see picture below). Make sure that the mounting holes on the bottom of the hard disk and disk tray are lined up. Secure the drive with four screws.

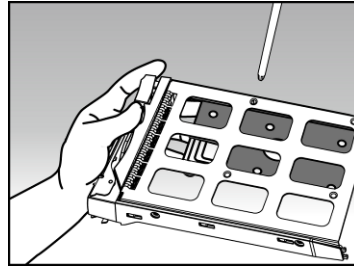
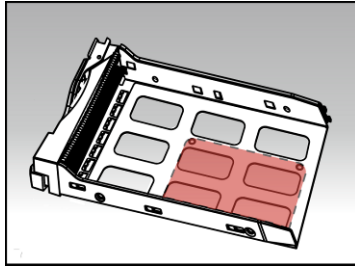

- Slide the disk tray onto the rails of the disk bay. Using the latch, gently push the disk tray all the way into the disk bay. Secure the disk tray in place by pushing down on the latch. The latch should close easily and snap in with an audible 'click'. Please make sure that the disk tray is pushed all the way into the disk bay before attempting to secure the latch.

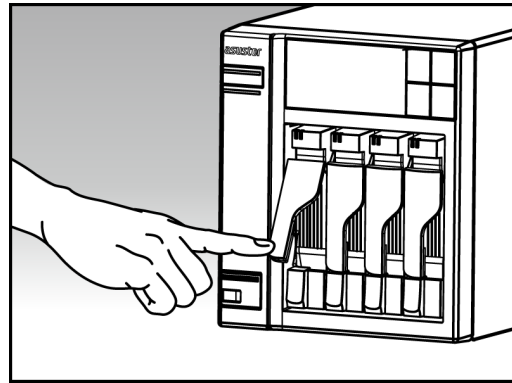
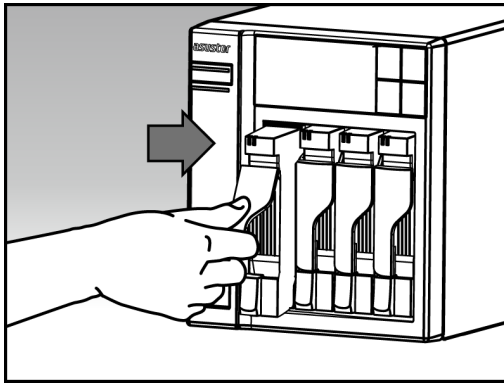

3.2. Connecting and Powering on the NAS

- Connect the NAS to its power supply.
- Connect the NAS to your router, switch or hub using an Ethernet cable.

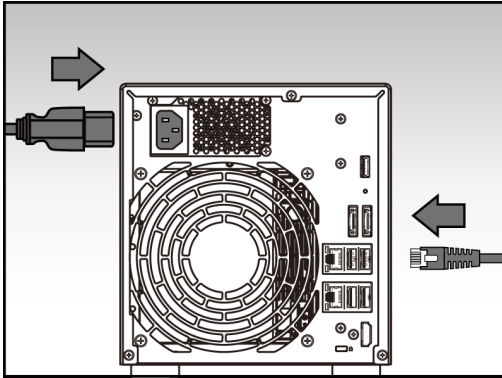

- Press and hold down the power button for 1 – 2 seconds until the blue power LED indicator is lit. This indicates that the NAS is now powered on. While the NAS is being powered on, the green system status LED indicator will flash and the blue network LED indicator will be lit as well.

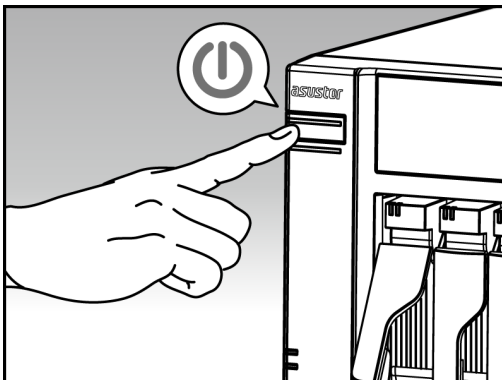

- The NAS is ready for operation once the green system status LED indicator has stopped flashing and remains steadily lit. At this time, you should also hear a 'beep' from the system buzzer. Hardware installation is now complete. Please move on to the software installation guide to configure your system settings.

3.3 Upgrading System Memory

3.2.1. Notes and Precautions

All AS 6 Series NAS devices support up to 3GB of memory. Before adding or removing memory modules, please read the following precautions thoroughly.

- Your NAS and memory modules use high precision components and electronic connector technology. To avoid invalidation of the warranty during your product warranty period, we recommend that:
 - ✓ You should contact your dealer to install a new memory module.
 - ✓ You should not install a memory module by yourself, if you are not familiar with upgrading memory on a computer.

- ✓ You should not touch the connectors or open the memory module compartment cover.
- Addition or removal of memory modules by yourself may result in an accident or malfunction of your NAS caused by breakage of the slot and module or a connection mistake. In this case, a repair fee will be charged.
- Be careful not to injure your hands or fingers with sharp edges of the memory module, inner components, or circuit boards of your NAS.
- ASUSTOR does not guarantee that third party memory modules will work in your NAS.
- Be sure to turn off your NAS and peripherals and disconnect all attachments and connection cables before adding or removing memory modules.
- To prevent damage from electrostatic discharge to memory modules, follow the instructions below:
 - ✓ Do not work at a location that produces static electricity easily, such as on a carpet.
 - ✓ Before adding or removing memory modules, touch an external metal object other than your NAS to ground yourself and eliminate static electricity. Do not touch any metal parts inside the NAS.
- Do not insert a memory module into the slot facing in the wrong direction. It may cause damage to the module or slot, or cause the circuit board to catch fire.
- Use a screwdriver that matches the size of the screws.
- Do not remove or loosen screws that are not specified to be removed.

3.2.2. Parts and Tools Needed

- Phillips head screwdriver
- Compatible Memory (DDR3 1333MHz SO-DIMM)

Brand	Type	Model	Size
ADATA	SDRAM	EL73I1A08	1 GB
ADATA	SDRAM	EL73I1B0873ZV	2 GB
Unigen	SDRAM	UG12U7400M8SU-ACO	1 GB
Unigen	SDRAM	UG25U6400N8SU-ACO	2 GB
Kingston	SDRAM	KVR1333D3S8S9/2G	2 GB

[More Memory Compatibility List](#)

3.2.3. Removing the Cover

- Shutdown the NAS by selecting **[Shut down]** from the ADM User Menu.



- Disconnect all cables and devices connected to the NAS including the power cord.

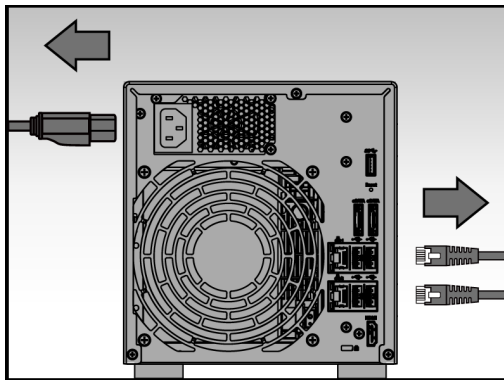

- Use a screwdriver to loosen the three screws found on the rear of the NAS as shown in the illustration.

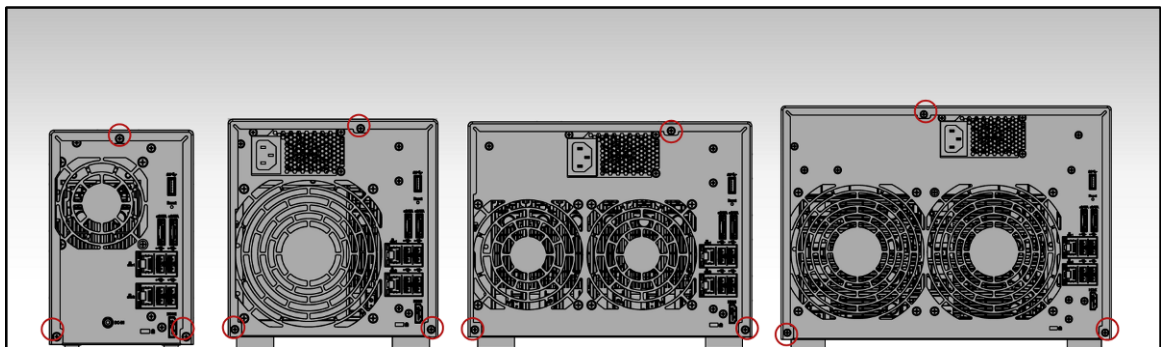

- Grip the cover from both sides with two hands and then gently push it back to remove it from the chassis.

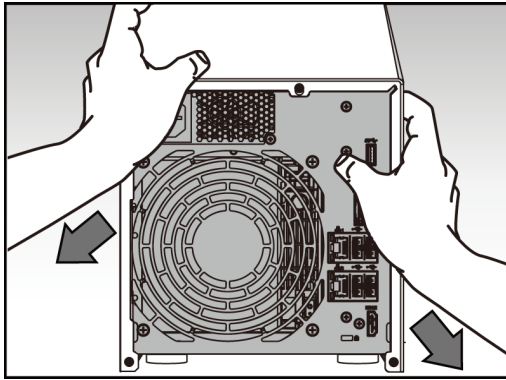

3.2.4. Installing Memory

- When inserting the memory module into the empty slot, please make sure to align the notches on the module with the notches in the slot.

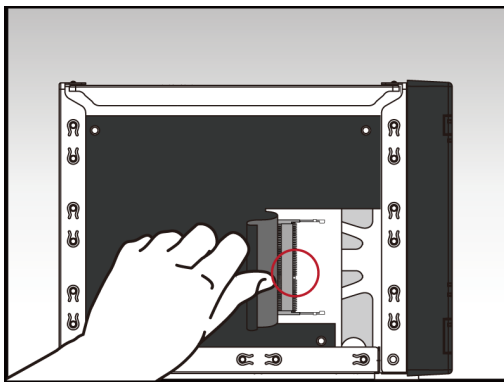

- Diagonally slide in the memory module (as shown in the illustration) making sure that the memory module's connectors are fully inserted into the slot.

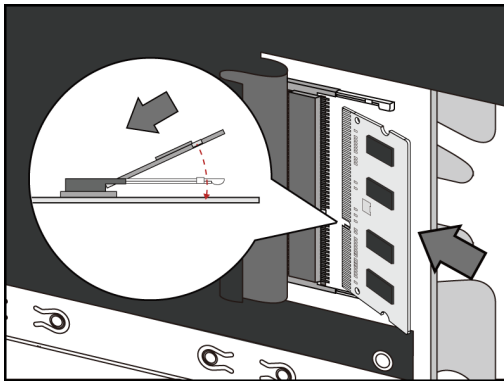

- Using two fingers, carefully push down and then back on the memory module until it clicks into place. You should be able to hear an audible "click".

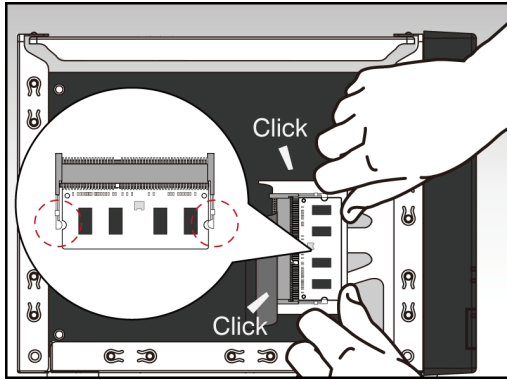

3.2.5. Replacing the Cover

- Replace the cover and tighten the three screws that were removed previously.

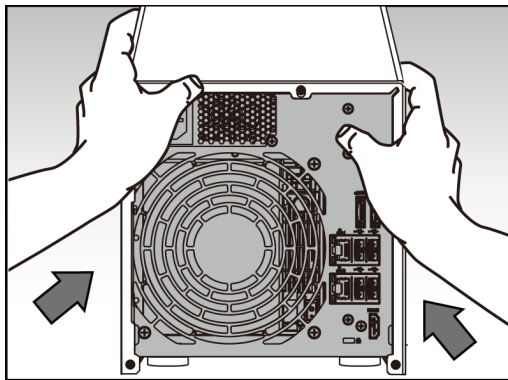

- Reconnect all cables including the power cord and then start up the NAS.

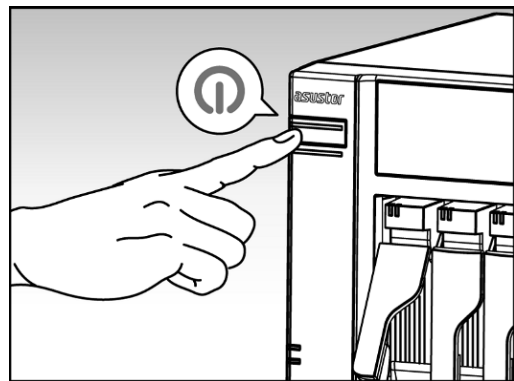
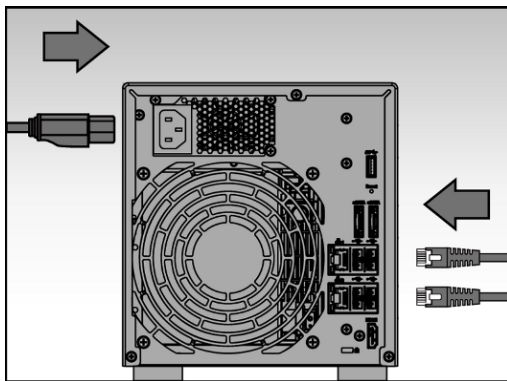

4. Software Installation Guide

There are 3 different installation methods that you can choose from. Please select the method most suitable for you. If you do not have a CD drive, you can go to the download section of the ASUSTOR website (<http://www.asustor.com/service/downloads>) to download the latest software.

4.1. CD Installation

4.1.1. Windows Users

- Insert the installation CD into your computer’s CD drive and then select “Start” from the autorun CD-menu.



- The installation wizard will install ASUSTOR Control Center onto your computer. After ASUSTOR Control Center has been installed, it will automatically begin to scan your network for ASUSTOR NAS devices.
- Select your NAS from the list and follow the installation wizard’s instructions to complete the configuration process.

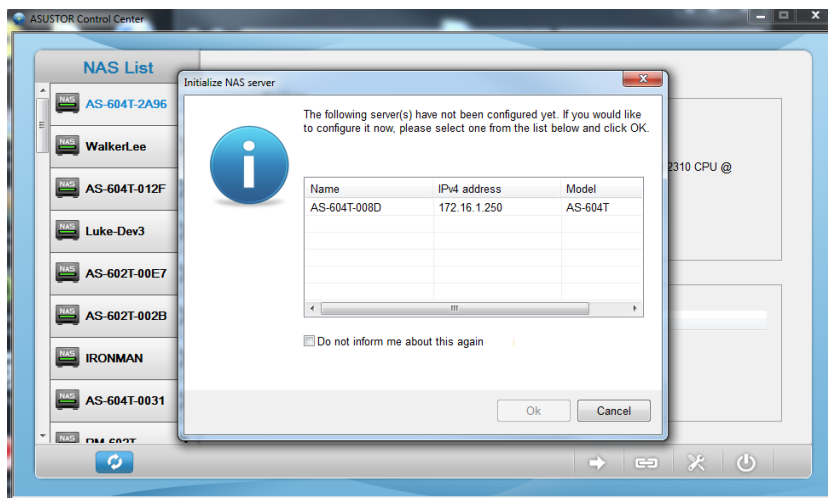

4.1.2. Mac Users

- Insert the installation CD into your computer's CD drive and then select "Quick Install" from the autorun CD-menu.

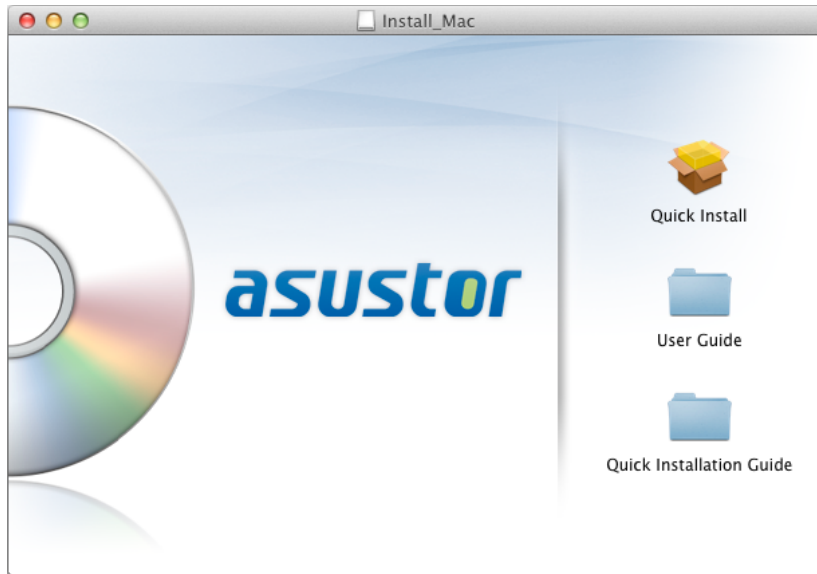

- The installation wizard will install ASUSTOR Control Center onto your computer. At this time you can also choose whether or not you want to install Download Assistant. After ASUSTOR Control Center has been installed, it will automatically begin to scan your network for ASUSTOR NAS devices.
- Select your NAS from the list and follow the installation wizard's instructions to complete the configuration process.

4.2. Web Installation

- If you already know your NAS's current IP address, you can open up a web browser and enter in your NAS's IP address (for example: http://192.168.1.168:8000) to begin initialization.
- Please follow the instructions from the installation wizard to complete the configuration process.



4.3. Installation Using the LCD Display

* Suitable for use with the AS-604T/606T/608T models

- The LCD display will ask you whether or not you want initialize the NAS once it has detected that the NAS has not yet started to initialize.
- Please use the "↵" button found on the right side of the LCD display to confirm that you want to initialize the NAS. The system will now start the initialization process.

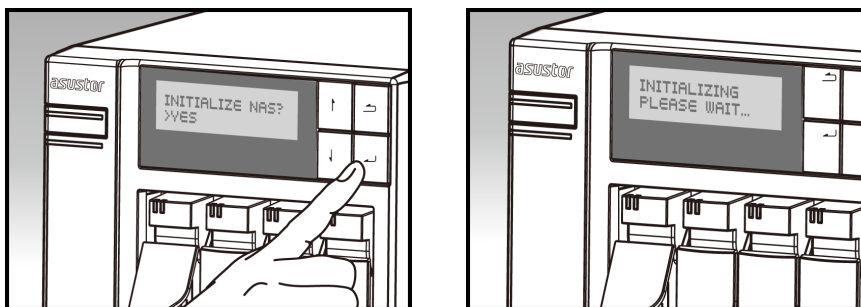

- Initialization is complete when the NAS's IP address is shown on the LCD display. NOTE: The password for the "admin" account will be set to "admin".

4.4. Installation Using a Direct Connection



Please see section [5.4 Troubleshooting](#) for installation instructions.

5. Appendix

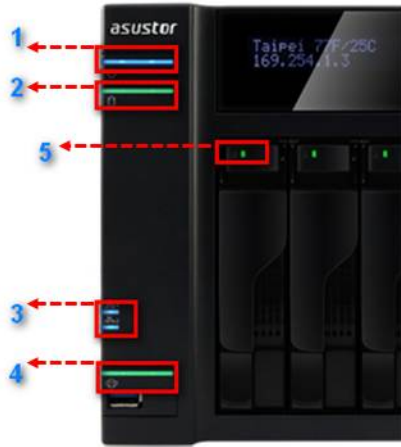
5.1. LED Indicators



1. Power LED Indicator
2. System Status LED Indicator
3. Network LED Indicator
4. USB LED Indicator
5. Hard Disk LED Indicator

LED Indicator	Color	Description	State
Power	Blue	Steadily lit	Power on
		Flashing	Waking from sleep mode (S3)
	Orange	Steadily lit	Sleep mode (S3)
		Flashes every 10 seconds	LED night mode
System Status 	Green	Flashing	Powering on
		Steadily lit	System ready
Network 	Blue	Steadily lit	Network port connected
USB 	Green	Steadily lit	The USB device connected to the front of the NAS is ready for use
		Flashing	Data access in progress
Hard Disk	Green	Steadily lit	Hard disk ready
		Flashing	Data access in progress
		Flashes every 10 seconds	Hibernation mode
	Red	Steadily lit	Hard disk abnormality

5.2. Rear Panel

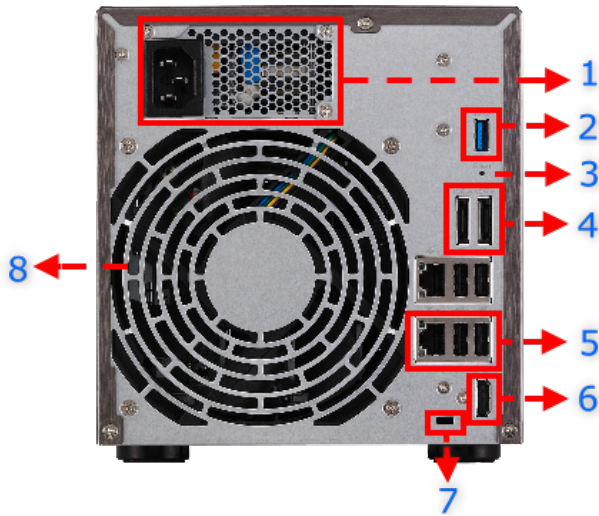

1. Power Supply
2. USB 3.0 Port
3. Reset Button
4. eSATA Port
5. RJ45 & USB 2.0 Port
6. HDMI Port
7. K-lock
8. System Fan

5.3. Rating Label



1. Model Name
2. Power Supply
3. Certification

5.4. Troubleshooting

Q: Why can't I detect my ASUSTOR NAS using ASUSTOR Control Center?

A: If you are having trouble detecting your NAS using ASUSTOR Control Center, please do the following:

1. Please check your network connection:
 - a. Make sure that your computer and your NAS are part of the same local area network.
 - b. Check to see if the network LED indicator is lit. If you find that it is not lit, try connecting your Ethernet cable to the other network port or try using a different Ethernet cable.
2. Please first disable any firewalls that may be running on your computer. Then try scanning for your NAS again using ASUSTOR Control Center.
3. If you still cannot detect your NAS, please connect your NAS to your computer using the provided RJ-45 network cable and change your computer's IP settings.
 - a. Select **[Start]->[Control Panel]->[Network and Sharing Center]**

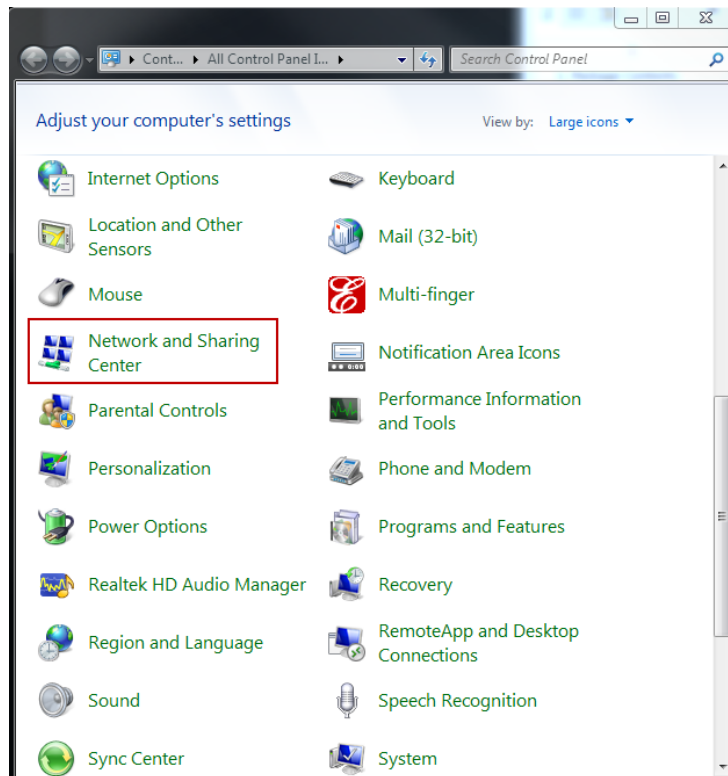

b. Click on **[Change adapter settings]** in the left hand panel.

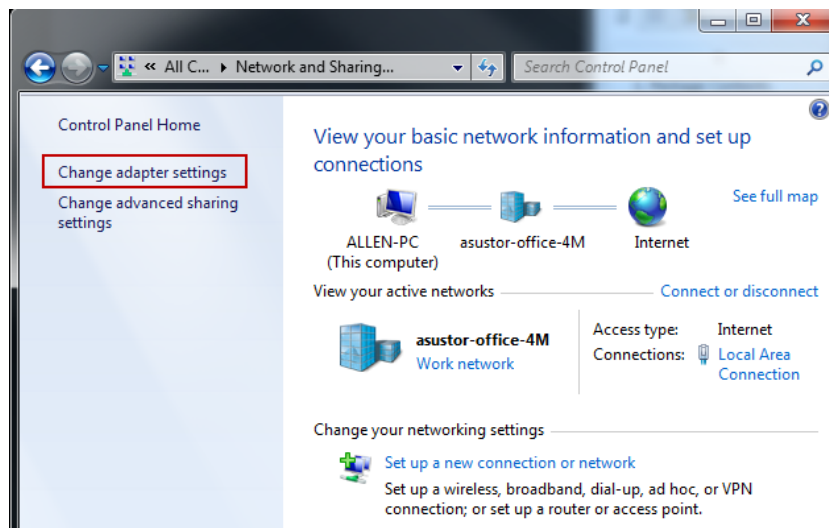

c. Right-click on **[Local Area Connection]** and select **[Properties]**.

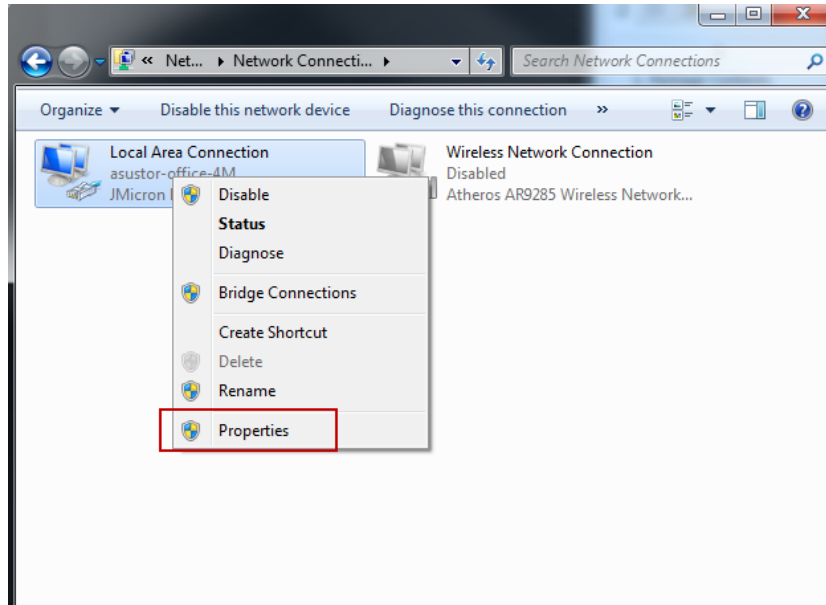

- d. Under the **[Networking]** tab select **[Internet Protocol Version 4 (TCP/IPv4)]** and click on **[Properties]**.

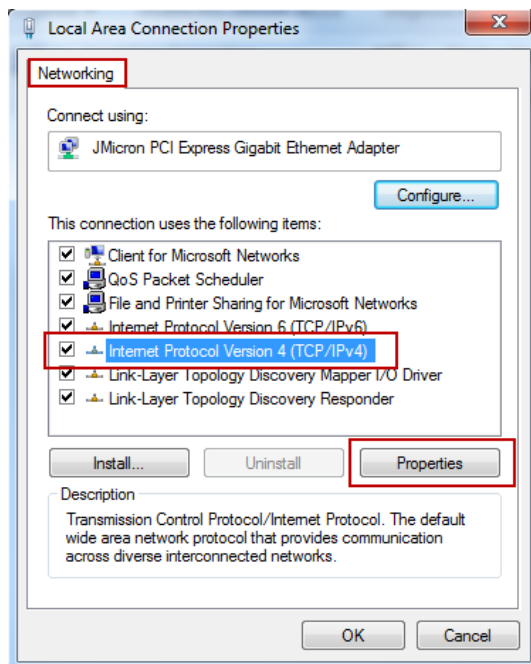

- e. Under the **[General]** tab select the **[Use the following IP address]** radio button. Set the **[IP address]** to **169.254.1.1** and the **[Subnet mask]** to **255.255.0.0** and then click on **[OK]**.

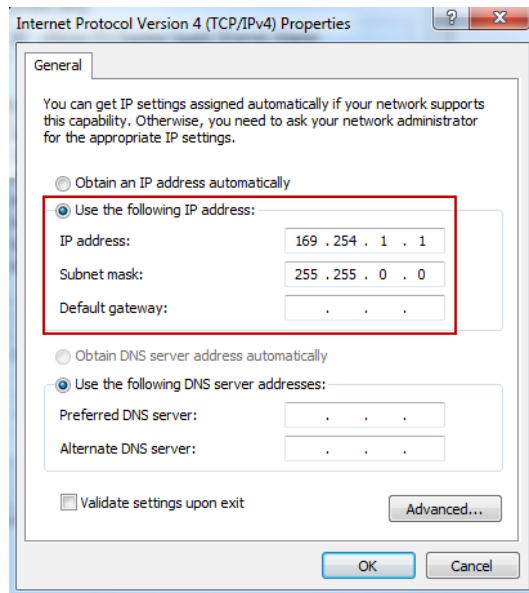

- f. Open up ASUSTOR Control Center to scan for your NAS.
4. If the above mentioned procedures have not managed to solve your problem, please contact your local ASUSTOR dealer or ASUSTOR Customer Service (<http://support.asustor.com>). You are also encouraged to browse through the [ASUSTOR Knowledgebase](#).