

5G VISION

Samsung Electronics Co., Ltd.

Date : August 2015

In the near future, users of mobile device will enjoy life-like multimedia contents everywhere and billions of connected devices will autonomously interconnect with one another so that new fancy services can be delivered to people. Not only will this add value to users' experience as customers, but also would present industries with a huge amount of new business opportunities from the demands for these new services. Samsung envisions the fifth Generation (5G) mobile communication to herald an era of truly immersive services. From this white paper, you can get hints of the future services, key requirements, and enabling technologies that will realize 5G.



**SAMSUNG
ELECTRONICS**



Dawn of the 5G Era

The symbiotic relationship between the two most transformative technologies, wireless communications and the Internet, has fuelled a phenomenal growth in the demand for mobile data. Unprecedented number of devices now connect, autonomously or user-driven, to the Internet using wireless technologies. 4G technologies and network architecture, which were primarily conceived in the pre-smartphone age, are simply overwhelmed and are unable to scale and keep up with this growth.

As shown in Figure 1, the number of connected Internet of Things (IoT) is estimated to reach 50 Billion by 2020 [1], while the mobile data traffic is expected to grow to 24.3 Exabytes per month by 2019 [2].

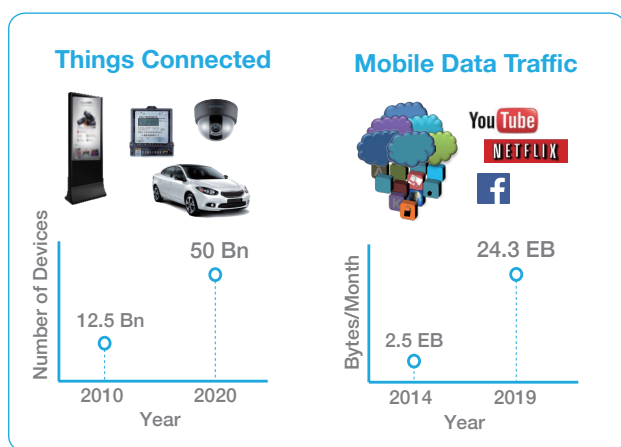

Figure 1 Growth in Mobile Traffic and Connected Devices

In addition, the end-user data rate requirements due to emerging new services such as Ultra-High-Definition (UHD) multimedia streaming and extremely low latency requirements for cloud computing and storage/retrieval stretch the 4G systems severely and render them too thin to deliver the quality of experience (QoE) necessary to support these services adequately.

The 5G Era has dawned. Industry efforts and investments to define, develop and deliver the systems and specifications for the fifth Generation (5G) mobile system and services are now well under way. 5G technologies promise to deliver the exceptionally high speed connectivity necessary to support immersive applications, a fully-realized IoT services framework, and lower latency with both spectrum and energy efficiency. To realize these benefits, 5G systems will differ fundamentally from their predecessors fuelling a series of ground-breaking innovations. Let's look at the services and the requirements that 5G is expected to address.

5G Service Vision

5G services have the potential to revolutionize the mobile experience. Here's how:

Immersive Multimedia Experience

In a 5G environment, users will be able to experience life-like multimedia streams anytime and anywhere. Users will feel as if they are part of the scene when they watch videos on their smart devices. An upcoming service that is expected to provide life-like experience in 5G system is UHD video streaming with its greatly enhanced resolution and clarity. UHD services over terrestrial broadcast are already being standardized in some countries. In addition, smartphones with cameras that can record video with 4K UHD quality are already available in the market. UHD services are expected to go mainstream by 2020, requiring enhanced performance in cellular systems to support such services.

Other examples of "immersive" services that would fundamentally revolutionize entertainment, health, education, and other industry sectors are Virtual Reality (VR) and Augmented Reality (AR).

VR will provide a world where physical presence is simulated by computer graphics, and the user can actively interact with the simulated elements, as in immersive sports broadcasting for instance (See Figure 2). Other interesting VR service scenarios are interactive 360° movies, online games, remote education, and virtual orchestra. Samsung's recently launched VR headset (called Gear VR), VR video service platform (called Milk VR) and 'Project Beyond,' (a 360° 3D camera with 17 Full HD (FHD) camera modules, optimal for generating contents for Milk VR) point to the humble beginnings of a truly immersive experience that is to come in the 5G Era.

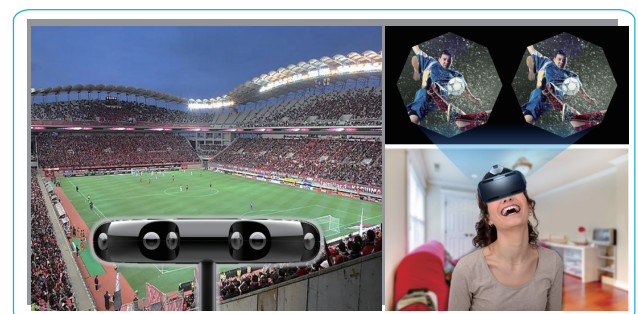

Figure 2 Watching Sport Events with VR

In an AR service scenario, computer-aided realtime information based on user context is graphically augmented to the display, delivering added value for the user. For example, in future, AR services can be used to aid customers in shops by informing them the price, popularity, and details of a given product - so that there would be no need for service desk attendants to memorize details of the products. Figure 3 illustrates another service scenario - AR navigation on windshield, where navigation information and other helpful notifications (refuel re-

minder and nearby shop location) are displayed on the windshield of a car, so that the user can focus on driving while getting subtle context-aware notifications about potential services at the same time.

Samsung is actively involved in the development of 5G technologies to support these immersive VR and AR services, which will entertain users and provide a truly life-like experience on the move.



Figure 3 Driving a Car with AR Navigation

Internet of Things

Devices in future would be able to maintain network connectivity regardless of time and location, and be capable of communicating with other devices without human intervention.

The basic fabric of the 5G system design is the support for up to million simultaneous connections per square kilometer, enabling variety of machine-to-machine services including wireless metering, mobile payments and telemedicine. Intelligent devices will communicate with each other autonomously in

the background and share information with each other. This ubiquitous connectivity - which is a basic tenet of the 5G services - will truly enable IoT services which in turn is expected to profoundly change human lives by connecting everything virtually.

– Smart Office

In smart office environments, office appliances will be connected with one another and share information. Nearby computers and input/output devices would be able to recognize a user and adapt the settings autonomously based on the user's preferences stored in the IoT cloud. Users will be able to print out documents by simply walking in the vicinity of a printer. Almost all the office appliances will connect wirelessly, while exchanging massive amounts of data through wireless medium without noticeable delay. Alerts on upcoming meeting, instantaneous availability of materials and documents relevant to upcoming meeting, automatic update of documents and tasks that are being modified, will be some of the many features of convenience of a smart office.

– Smart Store

In large shopping malls, shopper's vicinity to products will be continuously tracked, usually by a server somewhere in the cloud. When a user steps into a shop, a smart device can alarm the information of new products that may match user's taste, judged from the purchase history. Then, when the user approaches the product, customized alerts for dis-

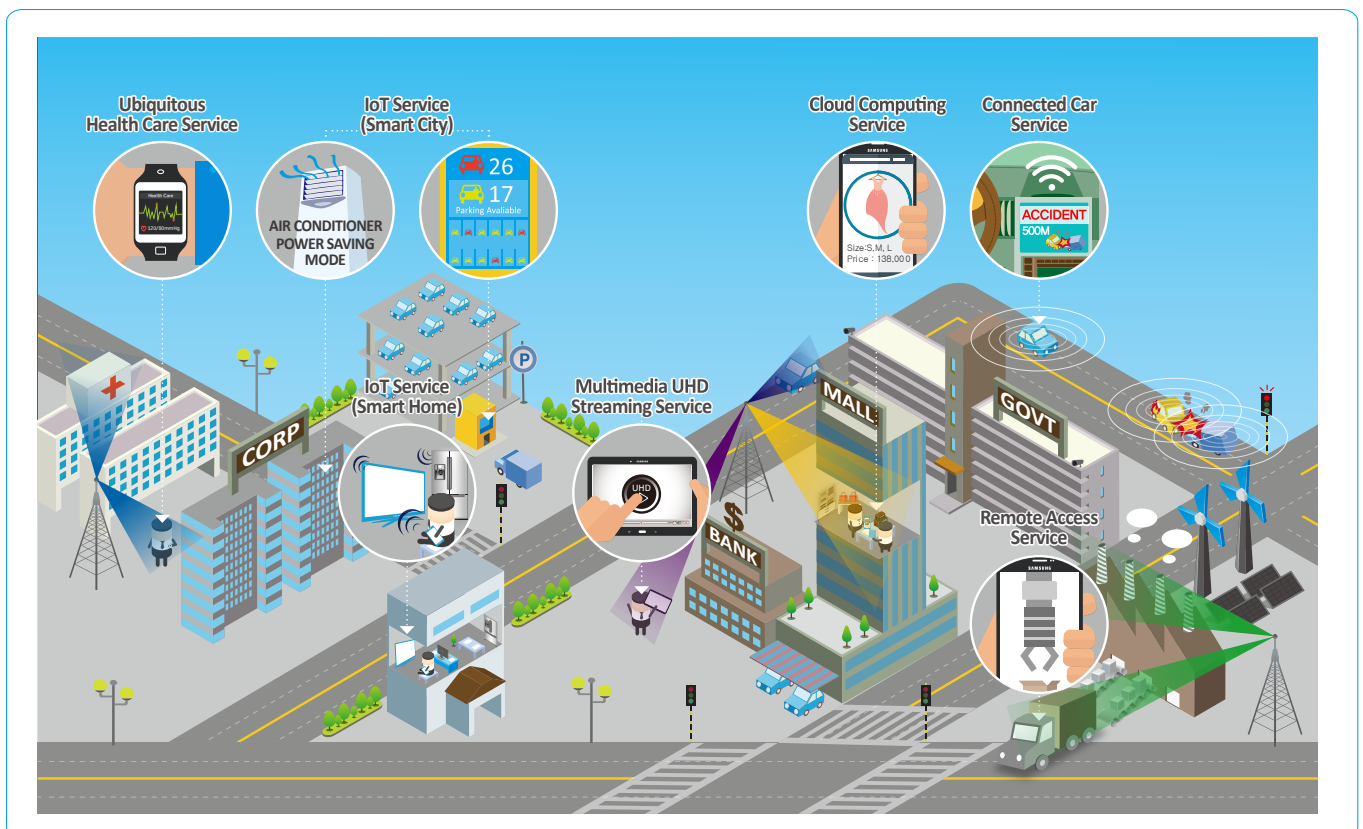

Figure 4 Major Service Scenarios with 5G

counted products, or price comparison information can be sent to the device. Such a system can be tailored to deliver a highly customized experience, thereby greatly enhancing users' shopping experience. To support such a scenario, massive connectivity and low latency technologies are necessary.

– **Smart Home**

In a smart home, dishwashers will fix themselves using information shared by peers of the same model. A smart refrigerator, recommending a recipe based on the ingredients that are in user's refrigerator, is yet another possible scenario. In addition, health-care devices connected at home would be able to send vital signs such as brainwave, blood pressure and heartbeat to an expert system in the hospital in real-time to prevent medical emergencies before they occur.

Intuitive Remote Access

Users will be able to control remote machines and appliances as if they are right in front of them, even from thousands of miles away. Thanks to the reliable connections and near-zero latency of 5G, users will be able to control heavy industrial machines, or access hazardous sites remotely.

For safer driving, sensor and camera data in a vehicle as well as supplementary information from the neighboring vehicles will be collected using mobile networks so that a potential emergency situation can be reliably informed to a driver in real-time and timely procedures can be taken to avoid an accident. This operation can eventually be applied to self-driving cars [3].

5G Requirements

In order to realize such a demanding and unprecedented 5G service vision, Samsung played a leading role in the ITU to define IMT-2020 capabilities consisting of 8 Key Performance Indicators (KPIs)

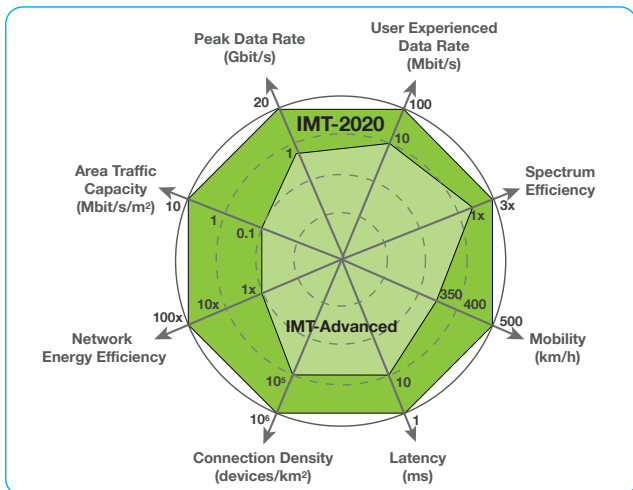

Figure 5 5G Key Performance Indicators

as shown in Figure 5. These KPIs are derived from the three main 5G use cases: Enhanced Mobile Broadband (EMBB), Ultra-Reliable and Low Latency Communications (URLLC), and Massive Machine Type Communications (Massive MTC).

According to these industry-agreed requirements, 5G systems will be required to deliver 20 times higher peak data rate and 10 times higher user experienced data rate compared to its predecessors. In particular, 5G systems are expected to support 100 Mbps data services regardless of a user's location and much higher data rate (e.g. 1 Gbps) for low-mobility users in hotspot areas. This aspect is illustrated in Figure 6 and Figure 7. To provide this uniform QoE, 5G network deployments are expected to be much denser compared to 4G networks, so cost-effective 5G deployment is a very important requisite.

To fundamentally support the cloud storage/computing infrastructure of the future, 5G networks will deliver an end-to-end latency of less than 5 milliseconds and over-the-air latency of less than one millisecond (see Figure 8) - which is one-tenth compared to 4G network latency.

With a spectral efficiency requirement 3 times higher than the 1-3 bps/Hz on 4G networks, 5G is also expected to guarantee an efficient use of the spectrum by using Multiple-Input and Multiple-output (MIMO), advanced coding and modulation schemes and new waveform design (more on this in the enabling technology section).

To address the widening revenue gap that the operators and service providers are experiencing, 5G systems are targeted to be 100 times more efficient

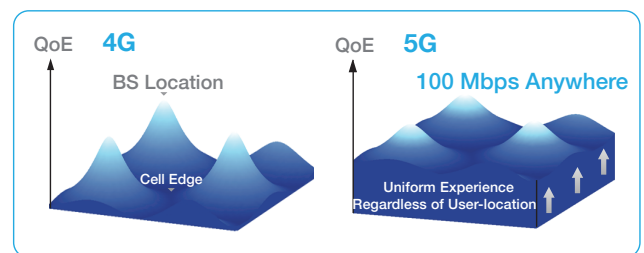

Figure 6 Edgeless RAN - 100 Mbps Anywhere

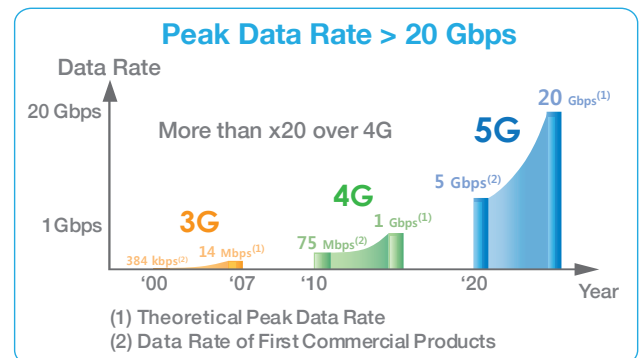

Figure 7 Data Rate Comparison of 5G with 3G and 4G

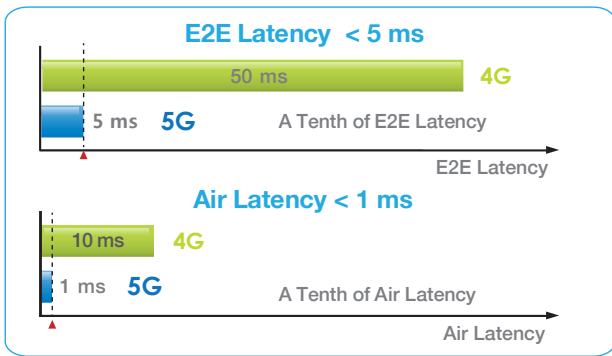

Figure 8 Ultra Low Latency of 5G

than the 4G systems by delivering 100 times more traffic using the same energy over the network. This in consequence necessitates low-cost network equipment, lower deployment costs, and enhanced power saving functionality on the network and user equipment sides.

5G technologies will be required to cope efficiently with all degrees of mobility by providing “mobility on demand” based on each device’s and service’s needs. 5G systems are also expected to enable high mobility up to 500 km/h with acceptable QoS. This is envisioned in particular for high speed trains.

In the vision for IoT services, the number of simultaneous connections in the 5G system is expected to be about 10^6 per square kilometer, which is ten times higher than that of the legacy system.

Further to the above key performance indicators, we describe more specific examples of requirements for 5G services as follows:

For instance, as well as the requirements on low latency, packet error rate (probability that data is successfully delivered in a pre-defined time) can be used as a requirement to ensure service reliability.

In the case of cellular IoT, which is mentioned here as a part of a broader IoT technology, the main requirements consist of power/cost efficiency, larger indoor coverage, and reduced complexity.

5G Key Enabling Technologies

Ground-breaking innovations in 5G technologies will allow future networks to achieve unprecedented speed, near-wireline latency, ubiquitous connectivity with uniform QoE, and the ability to support simultaneous connection of massive amounts of devices, all working in unison to provide the user with immersive experiences, even while the user is on the move.

Future 5G systems will encompass a wide range of fundamentally new designs that would boost wireless capacity, including utilization of new frequency bands, advanced spectrum efficiency enhancement methods in the legacy band, and seamless integration of licensed and unlicensed bands.

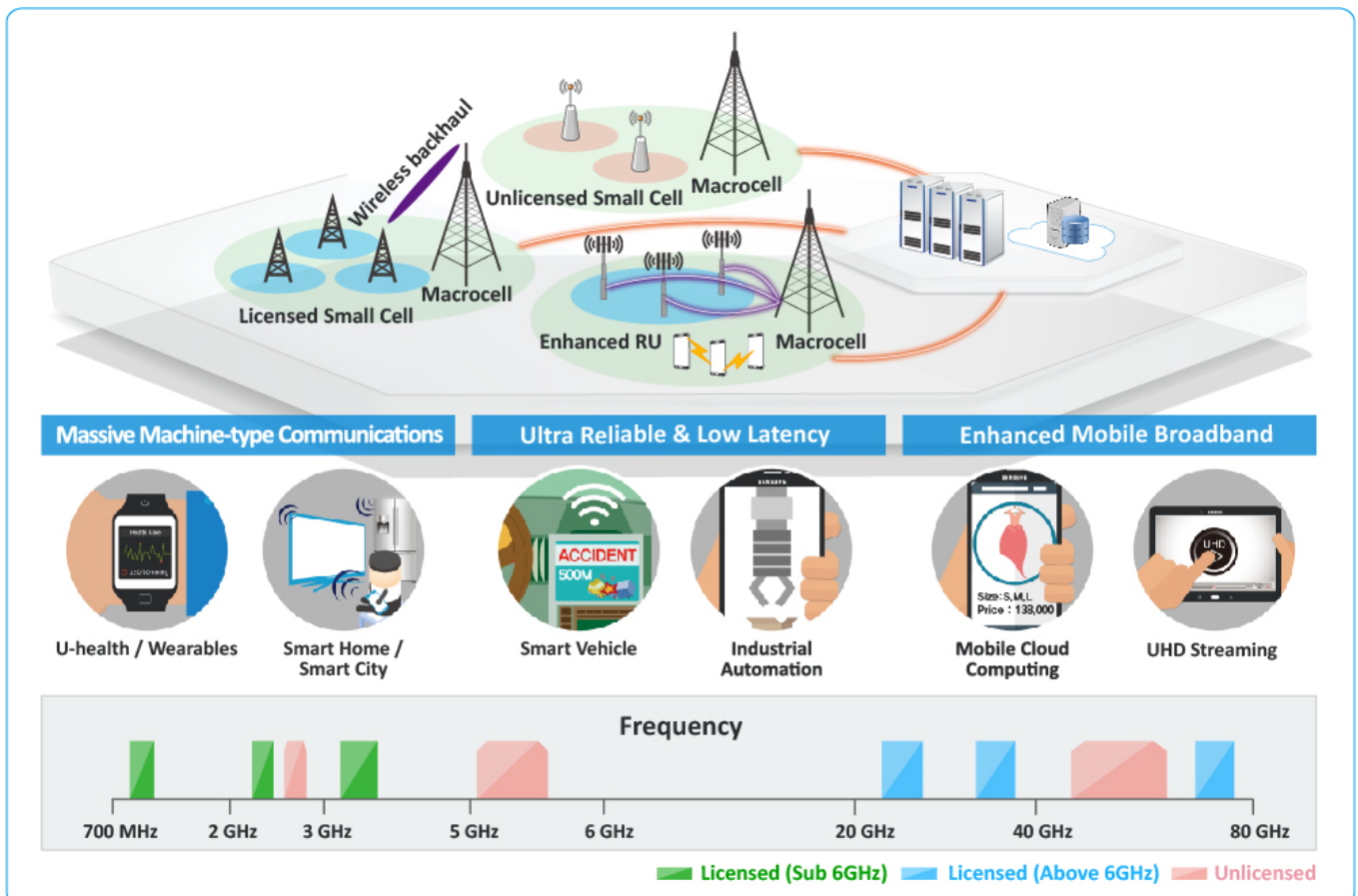
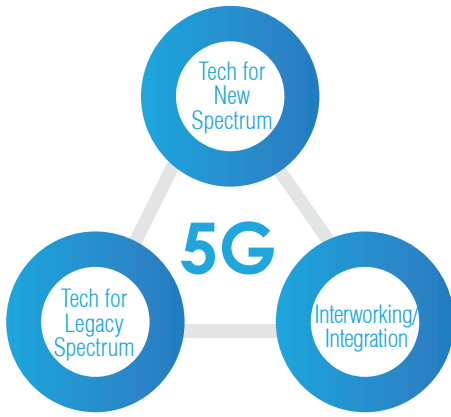
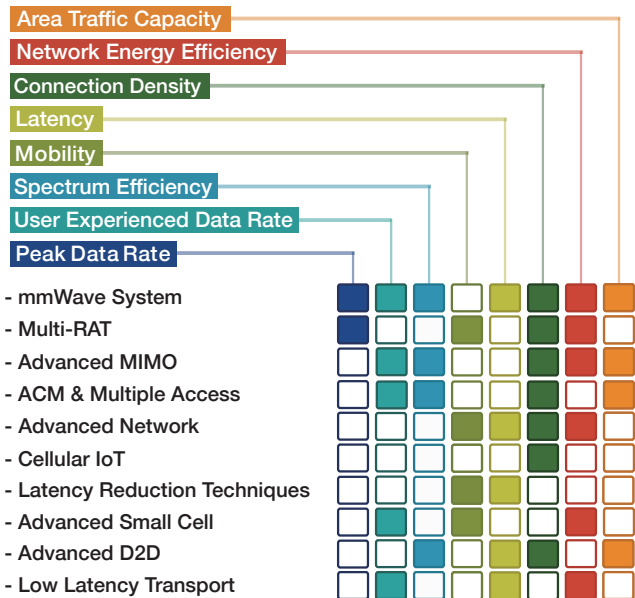

Figure 9 5G Deployment Scenarios



We further illustrate how these new designs can be integrated to support future 5G deployment scenarios, as shown in Figure 9. In this scenario, the Base Stations (BSs) in licensed band (sub 6 GHz) form the primary macro-cell “coverage” layer, while the BSs in the higher or unlicensed frequency band form the secondary small-cell “capacity” layer. In addition,



another type of dual/multiple connectivity would be a cell that is comprised of multiple cooperating radio units. We expect this network architecture to be very suitable in supporting the three key services for 5G: massive MTC, URLL, and EMBB.

Each service has unique requirement and needs careful considerations in both system and component technology design. For example, MTC service requires the massive number of devices to be connected and each device generate rather small size packets. Meanwhile, URLL focuses on fast and reliable data transmission while EMBB needs fat “pipes” for broadband data transmission.

Figure 10 shows an overview of the 5G key enabling technologies. Significant capacity improvement of the 5G network is achieved with the introduction of new technologies such as mmWave systems, high-density small cells, advanced MIMO and new multiple access schemes like Filter-Bank Multi-Carrier (FBMC). Adaptive Coding and Modulation methods such as Frequency and Quadrature Amplitude Modulation (FQAM) can significantly improve the cell edge performance. Together with higher density deployments with multi-BS cooperation, it can help deliver the 5G promise of “Gbps anywhere” and uniform QoE. Multi-Radio Access Technology (Multi-RAT) can integrate licensed and unlicensed bands to increase the available system bandwidth.

On the network side, novel topologies that support edge-based storage and computing will lead to significant reduction in the network latency. Advanced Device-to-Device (D2D) technology can also reduce the communication latency and support larger number of simultaneous connections in a network.

These 5G key enabling technologies are described in more detail in the following sections.

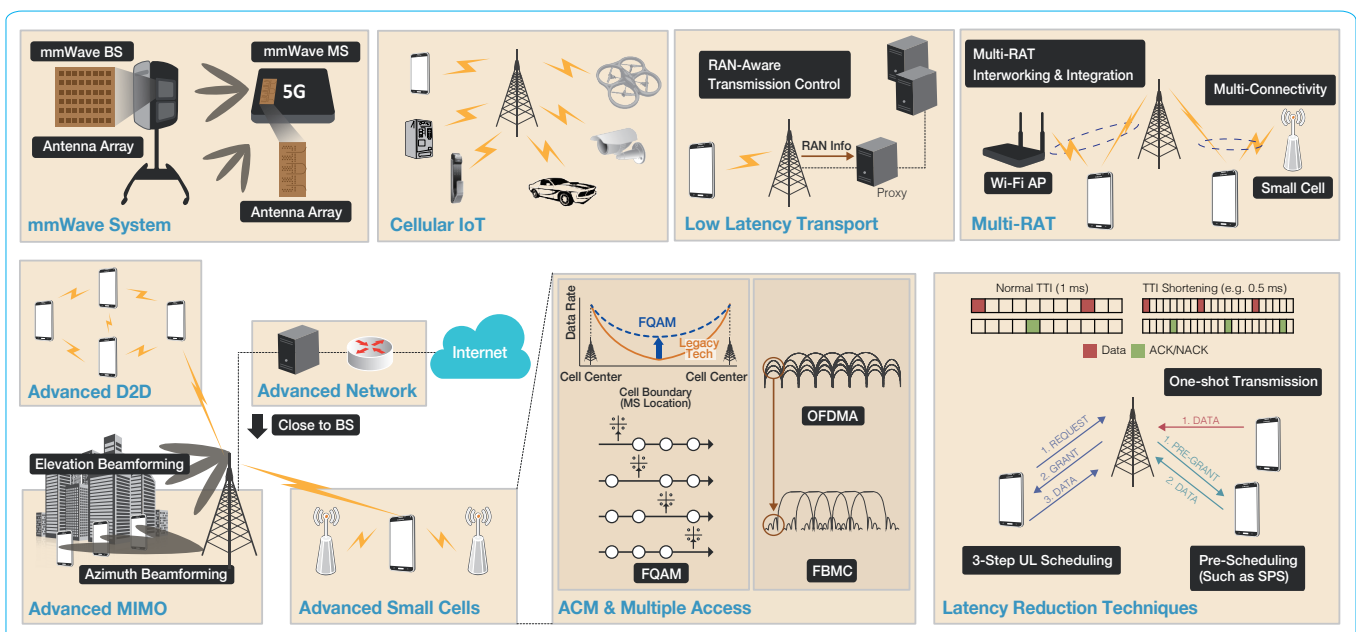

Figure 10 Overview of 5G Key Enabling Technologies

mmWave System

The mmWave band from 20~50 GHz alone includes 10 times more available bandwidth than the entire 4G cellular band, as illustrated in Figure 11. Therefore, the mmWave band can support higher data rates required in future mobile broadband access networks.

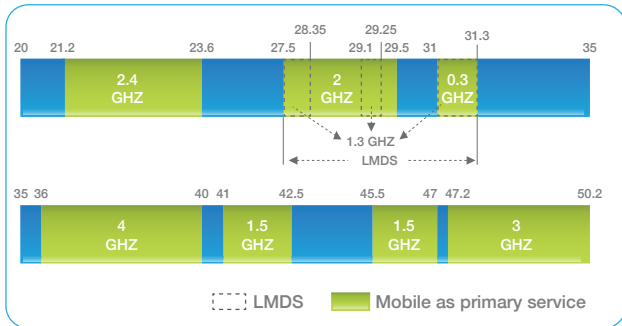

Figure 11 Potential Bands in 20-50 GHz (US)

The small wavelength in mmWave frequency allows design and deployment of massive antenna arrays with large beamforming gains necessary to combat the large propagation loss in the mmWave band.

We have developed such a mmWave beamforming prototype at the DMC R&D Center, Samsung Electronics, Korea, in order to demonstrate the feasibility of using mmWave bands for cellular services. We showed that our mmWave system can deliver a record-breaking 7.5 Gbps data rate to a static Mobile Station (MS) and still be able to achieve 1.2 Gbps data rate for a fast moving MS. Meanwhile, our system meets two key requirements of cellular services: sufficiently large geographical coverage and support for mobility in NLoS environments.

With extensive experiments in Daejeon, Korea [4] [5], we observed that reliable communication links are formed for NLoS sites that are more than 200 meters away from the BS. Moreover, we proposed ray-tracing based mmWave propagation and 3D-channel model for urban scenario in [6] and [7], respectively. To make outdoor communications a reality in the mmWave frequency, we had to over-

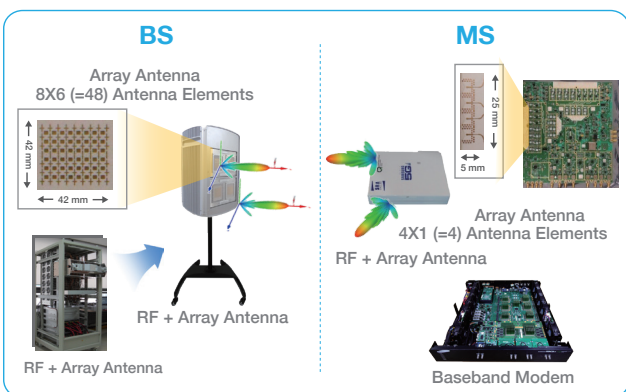

Figure 12 Adaptive Pencil Beamforming (Example)

come the higher pathloss and resulting fragile link in these mmWave band [8][9]. The adaptive directional beams with large antenna array gain are key in combating the large propagation loss in the mmWave band [10][11][12][13], as illustrated in Figure 12.

- mmWave MU-MIMO Test

In Figure 13, we illustrate the field test setup for the Multi-User MIMO (MU-MIMO) mmWave beamforming system. Two BSs are placed next to each other in an open space square, and each BS is pointing toward an MS.

Each BS transmits two streams of data simultaneously to the associated MS. In the test, each BS-MS pair achieves a data rate of 3.77 Gbps with 64-QAM and 3/4 code rate. The Block Error Rate (BLER) is about 0.017%, and a sum throughput of the 7.5 Gbps is achieved in the test.

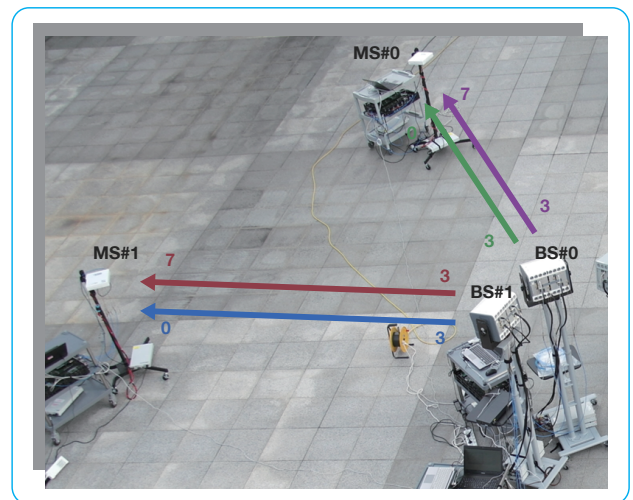

Figure 13 Stationary Cell Throughput Test using Two BSs-MS pairs

- mmWave Mobility Test

For a fast moving station, the adaptive beamforming performance is tested in a motorsports park, Everland Speedway, in Yong-In, Korea, as shown in Figure 14. A BS (bottom-left corner of the picture) contains two antenna arrays; each generated 8 beams in azimuth plane. The MS unit is mounted on the top of the vehicle. The MS has two antenna arrays and each array generated 8 beams and provided half of the 180° coverage. Figure 14 shows the movement of the vehicle during a 30-second interval where it moved from the 130 m point to the 800 m point. The received data is logged every 100 ms at the MS modem. Based on the feedback information from the MS, the BS updates the transmission beam and the Modulation and Coding Scheme (MCS) every 10 ms. The testbed achieved the throughput of over 1.2 Gbps with 16-QAM and 3/4 code rate during the test.

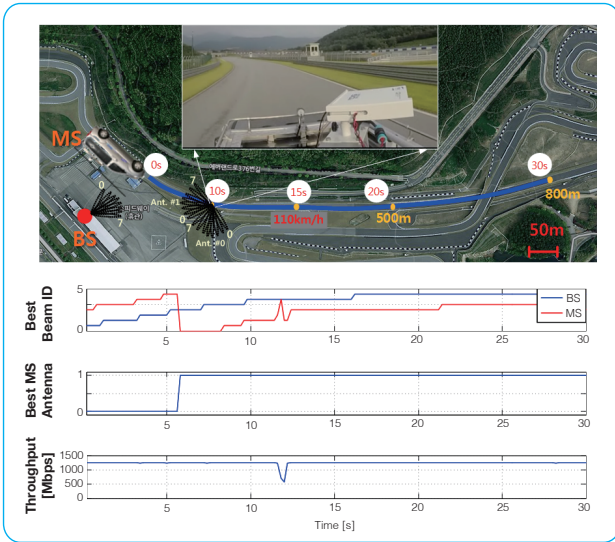

Figure 14 Adaptive Beamforming Test of a Fast Moving Station

- mmWave Chipsets and Antennas

Advancement in semiconductor technology has made commercial mmWave systems more readily available. Moreover, Samsung has been developing innovative 5G mmWave phased array antennas that have near zero-footprint and reconfigurable antenna modes.

Multi-RAT

Utilization of large system bandwidth is considered as an effective method to significantly enhance per-user throughput and overall system capacity. Finding spectrum bands with sizable available bandwidth is therefore one of the key challenges for future 5G systems. In this context, we think unlicensed bands hold a lot of potential for bandwidth growth: for instance, approximately 500 MHz and 7 GHz bandwidths are available in the 5 GHz and 60 GHz band, respectively. In order for a 5G system to utilize the unlicensed bands, it has to comply with a different set of regulations in the unlicensed band compared to traditional licensed bands, including Transmit Power Control (TPC), Dynamic Frequency Selection (DFS), and Listen Before Talk (LBT), etc.

Several technical aspects are considered in the following paragraph, with the goal of effective utilization of the unlicensed band for 5G systems. First of all, we will design PHY/MAC algorithms that are suitable for the nature of the unlicensed band, and that allows it to coexist well with other RATs (e.g., Wi-Fi or WiGig) in the same band. In addition, techniques for interworking and integrating the 5G system with other RATs in the unlicensed band will be developed. By connecting to the multiple RATs simultaneously, the 5G system will take advantage of their unique characteristics and improve the overall capacity and robustness of the system. We illustrate in Figure 15 such a multi-RAT system where the 4G

system is used for exchanging the control information to maintain the connection while the technology operating in the mmWave unlicensed band supports the gigabit data rate service.

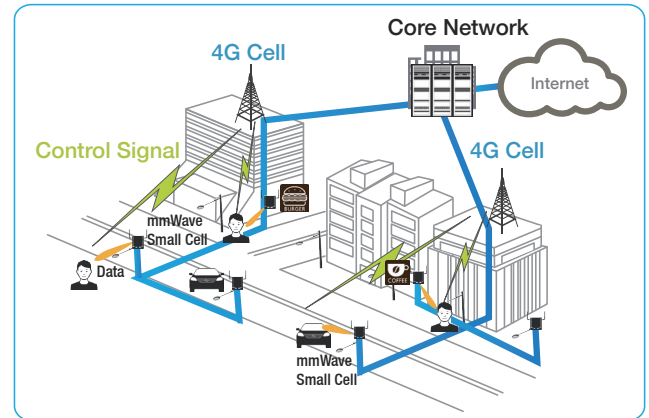

Figure 15 Overlaid Network of mmWave Small Cell integrated with the Underlay 4G System

Advanced MIMO

One promising technology for meeting the future demands is massive MIMO transmission/reception [14].

When used with multi-user precoding schemes such as Maximum Ratio Transmission (MRT) precoding, also known as channel conjugate precoding, massive MIMO systems experience small inter-user and inter-cell interferences, and consequently achieve significantly higher throughput than the state-of-the-art MIMO systems.

In practice, depending on the operating frequency and form factor requirements of a BS, there is a limit on the number of antennas that can be supported at the BS. For example, to horizontally install a large number of antenna elements (e.g., > 8) at the top of a BS tower operating with the lowest 4G system frequency bands of 700 MHz, eight antenna elements with 0.5λ spacing require up to 1.7 m width, where λ is the carrier wavelength. For the typical 4G system frequency bands of 2.5 GHz, fitting 32 antenna elements with 0.5λ spacing require up to 1.9 m width, which is not practical for many BSs that have only limited room on the tower. This practical limitation in 1D array has motivated Full-Dimension MIMO (FD-MIMO) cellular communication systems, which place a large number of active antenna elements in a two dimensional grid at the BSs.

A typical FD-MIMO deployment scenario is illustrated in Figure 16, for a macro BS with 3 sectors equipped with 2D Active Antenna Array (AAA) panels.

FD-MIMO system can support high-order MU-MIMO through 3D beamforming algorithms that fully exploit the elevation and azimuth dimensions, thereby generate improved system throughput.

In full buffer system-level evaluations, it is found a 64-antenna-port FD-MIMO system achieves 243% average-cell and 244% cell-edge performance gain, compared to those of the 8-antenna-port legacy MIMO system. In order to achieve the promising gains of an FD-MIMO system in practice, we need accurate beam steering and tracking in three Dimensions (3D).

To steer and track the MU beams for multiple MSs, FD-MIMO BS is typically equipped with multiple transceivers (TRX) feeding 2D-array elements, and the number of TRXs typically doubles or even quadruples that of the conventional BS.

Having a large number of TRX poses new challenges, such as antenna calibration and complexity issues associated with Channel State Information (CSI) acquisition and precoding.

In addition, high-order MU-MIMO introduces another set of new challenges, such as scheduling complexity and link adaptation. Furthermore, in Frequency Division Duplex (FDD) systems, other new challenges emerge such as pilot overhead, CSI estimation complexity, CSI quantization and feedback overheads.

An advanced prototype LTE Rel-13 pre-release FD-MIMO small cell eNodeB was developed by Samsung and was on display at this year's Mobile World Congress (MWC) 2015. This powerful prototype unit includes many advanced features but still has a compact footprint thanks to a fully integrated design that includes the 2D-array antenna, RF components, and baseband as shown in Figure 16.

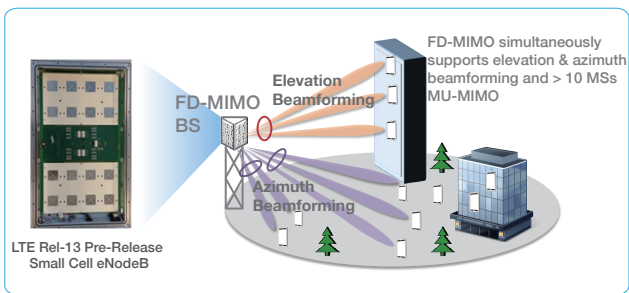

Figure 16 Example of FD-MIMO Deployment

ACM & Multiple Access

– QAM-FBMC

As cellular IoT has been one of the key driving forces to 5G, spectrally efficient support for heterogeneous services that have quite different requirements is becoming ever so important.

Recently, FBMC has drawn much attention as an enabling technology for enhancing fundamental spectral efficiency, though its theory has a long history similar to that of Orthogonal Frequency Division Multiplexing (OFDM).

Because of the well-localized time/frequency traits adopted from a pulse shaping filter per subcarrier, the FBMC system can reduce the overhead of guard band required to fit in the given spectrum bandwidth, while meeting the spectrum mask requirement.

Furthermore, the effectively increased symbol duration is suitable for handling the multi-path fading channels even without Cyclic Prefix (CP) overhead. Consequently, the FBMC system can reduce the inherent overheads such as CP and guard-bands in CP-OFDM. FBMC is also attractive in specific asynchronous scenarios, including Coordinated Multi-Point Transmission and Reception (CoMP) and Dynamic Spectrum Access (DSA) in a fragmented spectrum.

However, to maintain the transmission symbol rate, the conventional FBMC system generally doubles the lattice density either in time or in frequency compared with OFDM while adopting Offset Quadrature Amplitude Modulation (OQAM). In OQAM, in-phase and quadrature-phase modulation symbols are mapped separately with half symbol duration offset. Thus, so-called OQAM-FBMC or Staggered Multi-Tone (SMT) causes intrinsic interference that makes it difficult to apply conventional pilot designs and corresponding channel estimation algorithms as well as MIMO schemes as in Cyclic Prefix based OFDM (CP-OFDM) systems [15].

With a set of basefilters that takes the spectrum confinement and the orthogonality among subcarriers into consideration, a new QAM based FBMC system has recently been shown to perform comparable to the CP-OFDM system even without the CP overhead, while the guard-band overhead reduction is also available from the well-confined spectrum [16][17]. Sophisticated receiver algorithms including channel estimation and equalization can further mitigate the multi-path fading channel impact without the CP [17][18][19].

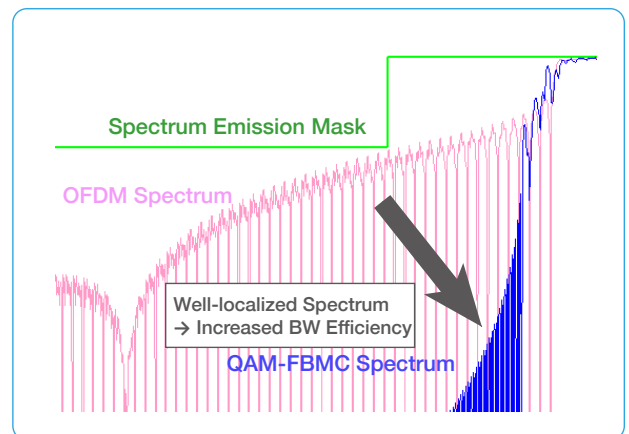

Figure 17 Spectrum Comparison between OFDM and QAM-FBMC

– FQAM

Conventional approaches to enhance the cell-edge performance mainly focus on managing interference (e.g., interference cancellation, interference avoidance), by dealing with interference as a Gaussian. However, it has been proven that the worst-case additive noise in wireless networks with respect to the channel capacity has a Gaussian distribution. From this observation, one can expect that the channel capacity can be increased by a non-Gaussian interference mitigation/reduction design which makes Inter-Cell Interference (ICI) non-Gaussian. The distribution of ICI depends on the modulation schemes of the interfering BSs. Therefore, an active interference mitigation/reduction design for improved cell-edge performance can be achieved by applying a new type of modulation.

FQAM, a combination of Frequency Shift Keying (FSK), and Quadrature Amplitude Modulation (QAM) can be used as an active interference design scheme. Figure 18 shows the signal constellation of 16-ary FQAM that is a combination of 4-ary FSK and 4-ary QAM.

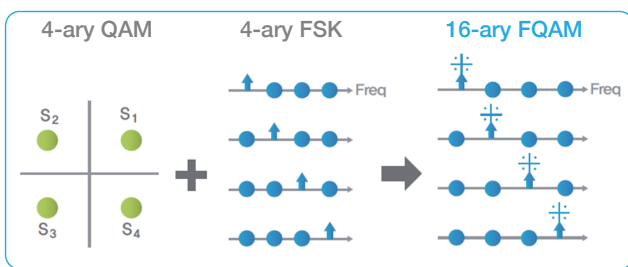

Figure 18 Example of 16-ary FQAM

With FQAM, the statistical distribution of ICI is likely to be non-Gaussian, especially for cell-edge users. As a result, the transmission rates for the cell-edge users can be significantly improved.

The statistics of ICI and the performance enhancement possibility have been proven by practical implementation of a system which uses FQAM. FQAM system environment for cellular downlink OFDMA networks is shown in Figure 19 and 20. Our experimental results show that the transmission rates for interference-limited users in FQAM-based OFDMA networks are around 300% higher than those in QAM-based OFDMA networks [20][21].

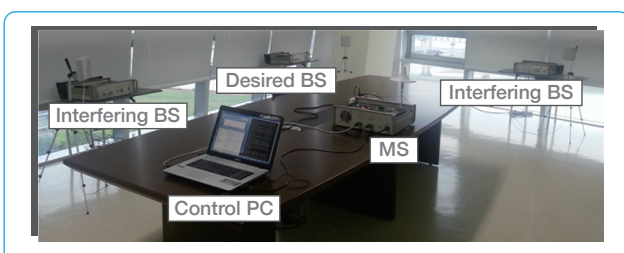

Figure 19 3 Cell Structure with MS and BSs

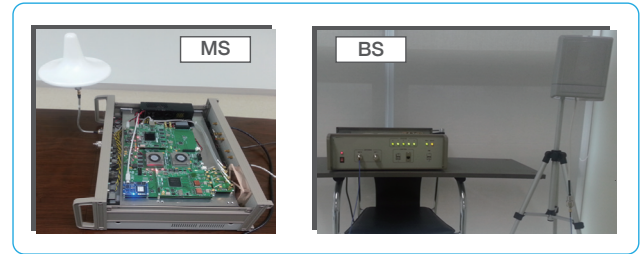

Figure 20 Implemented MS and BS

– Advanced Forward Error Correction

5G addresses many kind of services scenarios which need high data rate and ultra-reliable support. To this end, high decoder throughput and better performance in low code rate are required.

For decoder throughput efficiency with low power, the important metric for analyzing high throughput architectures is area efficiency, which is throughput per chip (=bps/mm²). Due to lack of parallelism of decoding algorithm, it is hard to support ultra high throughput with Turbo code.

Considering future service such as IoT, performance enhancement in low code rate (>1/3) is important. This advanced coding gain guarantee the ultra-reliable transmission on limited Tx power and wider coverage. Considering mission-critical service, performance enhancement of small packet on low operating point should be guaranteed. Since Turbo code has demerit on small packet performance and error floor phenomena in low operating point, enhancement on this aspect is very important.

Thus, Advanced FEC deserves consideration in aspects of the above-mentioned requirements.

Advanced Network

In order to fulfill key requirements of 5G (such as latency and the large number of simultaneous connections), technologies at the radio access level should be complemented by developments at the system architecture level from the network point of view. A new 5G network will have to evolve towards a distributed and flat architecture, in order to support the increased data rate facilitated by new 5G radio access technologies. In addition, 5G network would enable operators to build diverse set of business models and services.

Current mobile network architectures designate a dedicated node in the core network (e.g., PGW - Packet Data Network Gateway in 3GPP) as a mobility anchor that allocates an IP address to the terminal, tracks terminal location in the IP topology, and ensures terminal's reachability by tunneling its traffic to wherever it goes. All terminal traffic is tunneled through the centralized node in the mobile core net-

work. However, this design brings some undesirable consequences:

- Increase in end-to-end transmission latency due to elongated data paths.
- Additional load of backhauling and network processing in the core network.
- Low network reliability due to a single point of failure.

In the flat network architecture of 5G (as illustrated in Figure 21), the functionality of user mobility management is pushed to the edge of the network, and even onto mobile terminals [22]. This approach of distributed mobility management has several benefits in terms of efficiency and dynamic scalability:

First, constant provision of the shortest data path between MS and the Internet, without traversing the core network. This leads to a significant reduction in signaling and data transmission delay. Also, low end-to-end latency requirements of 'less than 5 ms for new 5G services such as immersive UHD video streaming, cloud gaming, and virtual reality, cannot be achieved solely by reducing radio access latency. In the flat network architecture, services which require low latency transmission can be provided by Edge Servers, which could be very near or co-located with a 5G BS. They can benefit from advanced network features which utilizes network information for optimal operations.

Second, a highly scalable solution compared to the centralized architecture, in which a single core network gateway maintains the whole traffic to and from MSs.

Third, mitigation of the risk from having a single point of failure. In flat network architecture, the breakdown of one network gateway would not significantly interfere with the operations of the other gateways.

Flexibility is another key requirement of 5G network architecture. Software-Defined Networking (SDN) and Network Function Virtualization (NFV) provide promising examples of programmable design tech-

nologies for realizing a flexible 5G network architecture which enable operators multi-service adaption of network functions to support a variety of services and corresponding QoS/QoE requirements.

Cellular Internet of Things

The use cases of IoT involve massive connections from power-efficient devices that are inexpensive and thus readily deployable at mass-scale. With the mass deployment and the diverse range of use cases, devices need to be reachable in extreme coverage conditions (e.g. indoor basement).

While it is possible to develop a new, dedicated radio access technology for IoT devices, it would be more efficient to utilize existing cellular networks e.g. GSM/EDGE, LTE - giving rise to the development of cellular IoT technology.

With these features in mind, developments for cellular IoT encompass aspects of protocol layer design as well as radio access techniques within the physical and data link layers. The overall principle is to reduce complexity and power consumption of IoT devices. This can be realized by providing generally slimmer protocols, and reducing the amount of control signaling that results in from having a large number of connections. Transmission techniques over the physical radio channels are designed such that IoT communication can take place on a small bandwidth and for extended coverage; the same goes for medium access control functions (e.g. scheduling, random access and paging mechanisms), which enable simple yet efficient usage of available radio resources.

Design principles of cellular IoT reflect the requirements and characteristics that are specific to IoT (see Figure 22), as well as those mentioned above. Some IoT applications such as smart metering may be less sensitive to delay and throughput performance, as they require sending only small packets of data occasionally, while others such as emergency breaking would requires high reliability and very low latency.

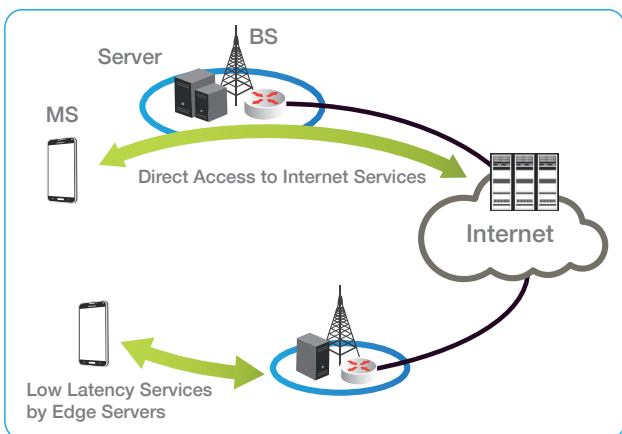

Figure 21 5G Flat Network Architecture

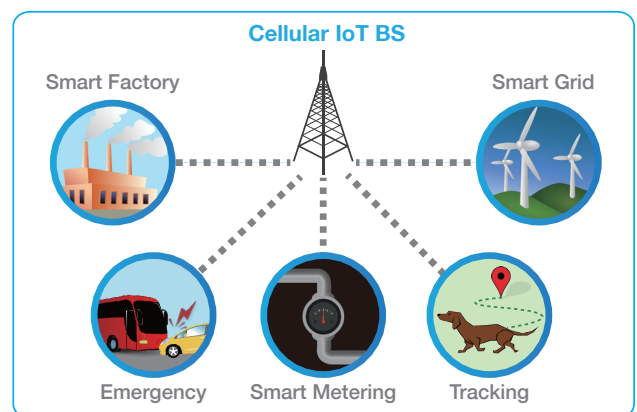

Figure 22 Cellular IoT Applications

Latency Reduction Techniques

5G system will be designed to satisfy diverse requirements from many different industries. To name a few examples of such requirements, content providers need to deliver high-quality multimedia services to customers without buffering latency. Automotive industries must have trustworthy mechanisms that enable information exchange between high-speed vehicles. Also, manufacturing companies require efficient methods to dynamically control robot arms and actuators in a factory.

Such examples clearly show the necessity of ultra reliability and low latency in 5G system, which were less emphasized in 4G system. These two aspects are related to each other in some sense because data reception in a shorter time leads to more transmission opportunities in a given time. To realize such technical demands with respect to reliability and latency, several issues are now being studied from PHY/MAC perspectives, as illustrated in Figure 23.

First, the introduction of shortened Transmission Time Interval (TTI) can be considered. The existing 4G system is currently based on the TTI length of 1 ms so that achieving end-to-end latency of a few milliseconds seems not feasible. Therefore, a set of new TTIs with the order of several hundreds of microseconds will be the basics of low latency. TTI reduction should impact on the design of reference signals, control signaling and HARQ. Moreover, co-existing different TTIs in a single carrier should raise a new challenge regarding waveform numerology.

Next, enhancements in scheduling and channel access procedures can be considered. While up-link procedures such as (i) request-grant-based scheduling, (ii) semi-persistent scheduling and (iii) random access, have been well defined for the existing 4G system, they have not been optimized for providing ultra reliability and low latency: there still are a significant amount of protocol overhead and collision occurrence. To find a more efficient way, we can develop the adaptive mode selection between scheduled access (to avoid collision) and random access (to remove the protocol overhead).

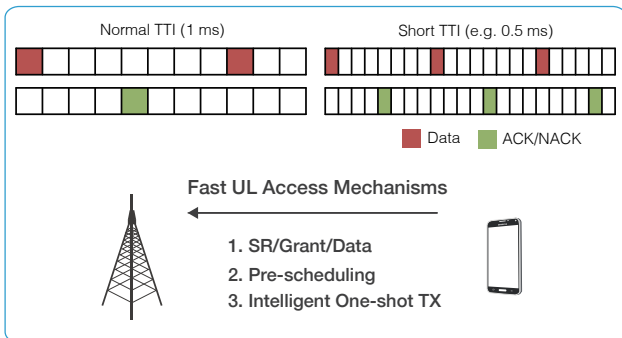

Figure 23 TTI Shortening and UL Scheduling for Ultra Reliability and Low Latency

In addition, advanced transceiver capabilities make grant-free multiple access and asynchronous one-shot transmission possible. By using them on top of time/frequency/spatial diversity, user-perceived performance in terms of reliability and latency is expected to be significantly improved.

Advanced Small Cell

To achieve significant throughput enhancement in a practical manner, it is necessary to deploy a large number of cells in a given area and to manage them intelligently. The 5G system is expected to utilize higher frequencies to take advantage of the vast bandwidth in the mmWave bands. Hence, the considerably high propagation loss of mmWave makes it suitable for dense small cell deployment, which leads to higher spatial reuse.

In addition to this, Figure 24 shows the concept of a user-centric virtual cell. Conventional static network topologies with a central controller have an “edge”, the reach of the central controller. However, a user-centric virtual cell that consists of a group of cooperating BSs is continuously reformed so that any user will always find himself/herself at the “center” of the cell.

While the increase of the number of small cells guarantees the system capacity enhancement, it also increases the deployment cost which is mainly from site rent, lease of the fiber and labor expense for the BS establishment. The wireless backhaul technology is necessary to handle the deployment complexity and cost of small cell. It will support the distributed and self-configuring network technologies.

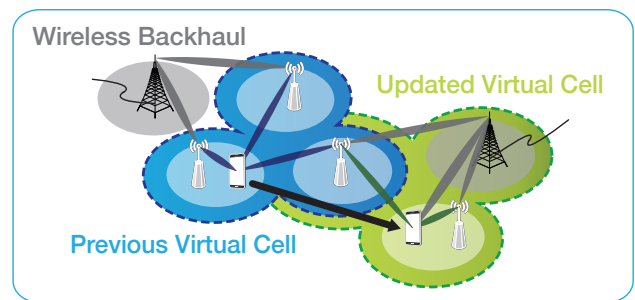

Figure 24 User Centric Virtual Cellular Network

Advanced D2D

Advanced D2D communication is an attractive technology that enhances spectral efficiency and reduces end-to-end latency for 5G. D2D devices can communicate directly with one another when they are in close proximity without depending on the cellular network. Therefore, D2D communication can be used for offloading data from network so that the cost of processing those data and related signaling is minimized. Moreover, enhanced version of

D2D communication was suggested lately for being used as special purpose such as Mission Critical Push-To-Talk (MCPTT) communication and Vehicle-to-Anything (V2X) communication.

In advanced D2D communication, a single radio resource can be reused among multiple groups which want to communicate with each other if the interference incurred between groups is tolerable. Thus, we can increase the spectral efficiency and the number of simultaneous connections by utilizing D2D communication in 5G. Moreover, since the data is directly transmitted and does not go through the core network, the end-to-end latency can be considerably reduced. In this way, advanced D2D communication is well aligned with IoT services as shown in Figure 25. Cars can communicate with each other to exchange the information for safety alarm and infotainment without cellular BS. Home appliances communicate with each other for home automation service. Many objects in proximity region can be connected to each other so that IoT services can be accomplished.

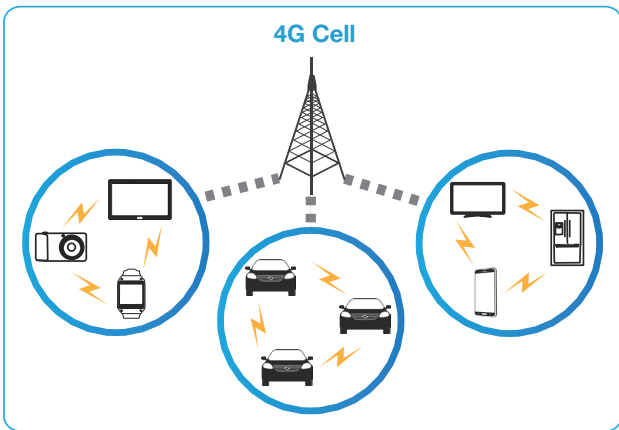

Figure 25 Advanced D2D Communications

Low Latency Transport

Low end-to-end transmission latency requirement of 5G (< 5 ms) requires radical changes in the network design as well as the improvement in the radio access technologies. This involves design of a new network architecture, functionalities of network node, network protocols, and etc.

A flat network architecture, which has been described in the previous section, enables an application server to be deployed at network edge nodes and facilitate the provision of a low latency service. In this section, among these changes, we will deal with issues in the transport layer design for low latency communication.

One of the fundamental problems in the design of a transport layer for a cellular network is difficulty in estimating quality of a time-varying radio link. Assessing variations of radio link quality by a transport

layer protocol, e.g. TCP, takes considerable time comparing with instant fluctuation of signal strength at a radio link. The transport layer at an end node, i.e., a mobile or a server in Figure 26, can only conjecture the congestion status of an end-to-end communication path by examining packet losses or feedback messages from a receiver. However, the inaccuracy involving aforementioned radio link quality estimation by a transport layer aggravates delay by inducing the buffer bloat at BS.

To eliminate the drawbacks from the passive estimation, RAN-aware transport protocol can be considered which uses an explicit feedback of radio link quality information to the transport layer.

A network function, noted as TCP Proxy in Figure 26, is defined to control the data transmission between a mobile and an application server.

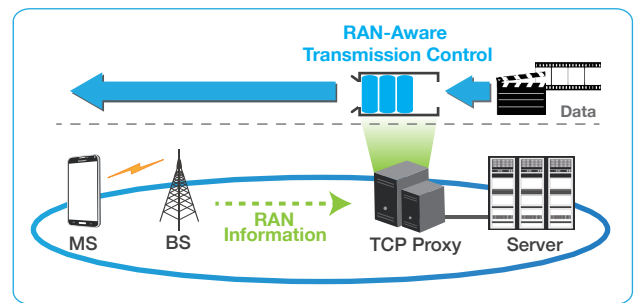

Figure 26 Proxy-based Network Architecture for RAN-Aware Transmission Control

Standardizations and Regulations

As shown in Figure 27, 5G is slated to be commercialized in 2020. ITU-R WP 5D is preparing timelines in the vision document for standardization, spectrum allocation, and commercialization, in order to be on time. From the perspective of commercialization, standards for 5G should be ready by the half of 2017 to allow 2 or 3 years for the development of 5G products. Considering average periods of previous standardization, 5G standards need to get started in 2015 to make 5G standards available by the first half of 2017.

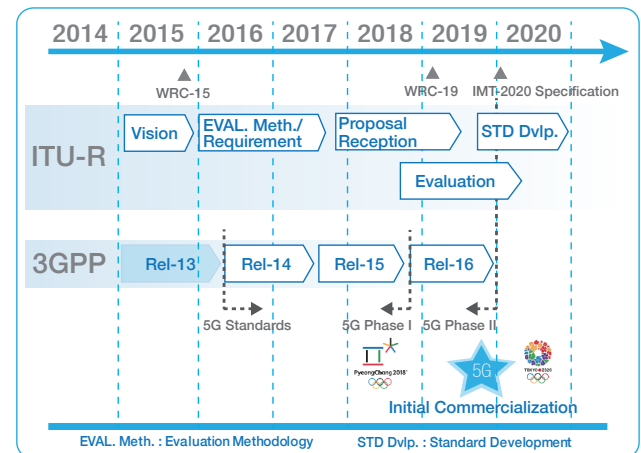

Figure 27 5G Timelines

Samsung will drive the phased approach for 5G standardization, which will begin in 3GPP release 14 with studies on a new RAT, as well as those on both above-6 GHz and sub-6 GHz spectra. The EMBB service characteristics will be considered with the first priority in the standard. In release 15, considered to the first phase of 5G, detailed discussion on the development of the new RAT will begin, based on the results of the study in release 14. The release 16 will be the second phase of 5G and will deal with further enhancement and optimization of 5G phase-1. In addition, other service such as URLL and Massive MTC will be reflected in the specification. The timeline for the standardization has been established with the aim of meeting early commercial demands around 2020.

Further, as shown in Figure 28, Samsung is actively engaged in key of global 5G research initiatives, such as membership of the Steering Board of European 5G PPP projects of Horizon 2020, as well as coordination and leadership of the very large industry led 5G PPP mmMAGIC consortium (<http://5g-mmMAGIC.eu>) [23], 5G Innovation Centre (5GIC) in UK, NYU Wireless Center in US, Giga KOREA project and Chinese 836 project.

the 5G system will introduce life-changing services providing the users with a truly immersive and rich experience. Moreover, massive number of connected devices can communicate with each other through 5G system, which will be the seed of a new business for industries. 5G promises to reverse the widening revenue gap and make it worthwhile for operators and service providers to invest again in innovative new services, and to achieve towards increased productivity and efficiency.



Figure 28 Global 5G R&D Activities

Samsung is leading various collaborations with industrial partners and academics over the world. In particular, Samsung has played an important role as the full member of 5G PPP Infrastructure Association, the executive board member of 5G Forum in Korea and the chair of vision sub-working group for Future IMT (5G) in ITU-R WP5D.

In order to keep a consistent perspective on 5G with those of other academic institutes, we are vigorously developing 5G core technologies with several outstanding universities around the world.

Conclusion

5G will usher in a revolutionary generation of mobile communication that provides high data rate regardless of the user’s location. Significantly increased system capacity and real-time responsiveness of

Reference

- 1 UMTS, "Mobile Traffic Forecasts 2010-2020 Report," UMTS Forum, Jan. 2011.
- 2 Cisco, "Cisco Visual Networking Index: Global Mobile Data Traffic Forecast Update, 2014-2019," Cisco, Feb. 2015
- 3 Calum Dewar et al., "Understanding 5G: Perspectives on future technological advancements in mobile," GSMA Intelligence Report, Dec. 2014.
- 4 Sooyoung Hur et al., "Wideband Spatial Channel Model in an Urban Cellular Environments At 28 GHz," in Proc. EuCAP'15, April. 2015.
- 5 Yean-Jea Cho et al., "Statistical Spatial Channel Model for In-building and Urban Environments at 28 GHz," submitted to IEEE Trans. on Vehicular Technology, May 2015.
- 6 Sooyoung Hur et al., "28 GHz Channel Modeling Using 3D Ray-Tracing in Urban Environments," in Proc. EuCAP' 15, April. 2015.
- 7 Sooyoung Hur et al., "Proposal on mmWave Channel Modeling for 5G Cellular System," submitted to IEEE Journal of Selected Topics in Signal Processing, June 2015.
- 8 Zhouye Pi et al., "An Introduction to Millimeter-Wave Mobile Broadband Systems," IEEE Communications Magazine, vol.49, no.6, pp.101-107, Jun. 2011.
- 9 Cheol Jeong et al., "Random Access in Millimeter-Wave Beamforming Cellular Networks: Issues and Approaches," IEEE Communications Magazine, vol. 53, no. 1, pp.180-185, Jan. 2015.
- 10 Wonil Roh et al., "Millimeter-wave Beamforming as an Enabling Technology for 5G Cellular Communications: Theoretical Feasibility and Prototype Results," IEEE Communications Magazine, vol. 52, no. 2, pp. 106-113, Feb. 2014.
- 11 Samsung, "Technologies for Rel-12 and Onwards," RWS-120021, 3GPP TSG RAN Workshop on Rel-12 and Onwards, Jun. 2012.
- 12 Taeyoung Kim et al., "Tens of Gbps Support with mmWave Beamforming Systems for Next Generation Communications," in Proc. IEEE GLOBECOM'13 Workshop, pp.3685-3690, Dec. 2013.
- 13 Chanhong Kim et al., "Multi-Beam Transmission Diversity with Hybrid Beamforming for MIMO-OFDM Systems," in Proc. IEEE GLOBECOM'13 Workshop, pp. 61-65, Dec. 2013.
- 14 Young-Han Nam et al., "Full Dimension MIMO (FD-MIMO) for Next Generation Cellular Technology," IEEE Communications Magazine, vol. 51, no. 6, pp.172-179, Jun. 2013.
- 15 Maurice Bellanger et al., "FBMC Physical Layer: a Primer," PHYDYAS Tech. Rep., Jun. 2010.
- 16 Yeo Hun Yun et al, "A New Waveform Enabling Enhanced QAM-FBMC Systems," in Proc. IEEE SPAWC'15, pp.116-120, Jun. 2015
- 17 Chanhong Kim et al, "QAM-FBMC: A New Multi-Carrier System for Post-OFDM Wireless Communications," IEEE GLOBECOM'15, accepted
- 18 Yong-Ho Cho et al, "Channel Estimation Performance of OQAM/FBMC and QAM/FBMC Systems," IEEE ISWCS'15, accepted
- 19 Kyeongyeon Kim et al, "Pre-processing Based Soft-Demapper for Per-Tone MIMO Operation in QAM-FBMC Systems," IEEE PIMRC'15, accepted
- 20 Sunghnam Hong et al., "A Modulation Technique for Active Interference Design under Downlink Cellular OFDMA Networks," in Proc. IEEE WCNC'14, pp.683-688, Apr. 2014.
- 21 Sunghnam Hong et al., "Frequency and Quadrature-Amplitude Modulation for Downlink Cellular OFDMA Networks," IEEE Journal on Selected Areas in Communication, vol. 32, no. 6, pp.1256-1267, Jun. 2014.
- 22 Alper Yegin et al., "Terminal-centric Distribution and Orchestration of IP Mobility for 5G Networks," IEEE Communications Magazine, vol. 52, no. 11, pp.86-92, Nov. 2014.
- 23 Maziar Nekovee et al., "Millimetre-Wave Based Mobile Radio Access Network for Fifth Generation Integrated Communications (mmMAGIC)", Proc. of European Conference on Networks and Communications (EuCNC) 2015, Paris

Samsung Demonstrates a Trio of 5G Technology Candidates at MWC 2015

Moves ahead once again in 5G Technology

SEOUL, Korea – February 26, 2015 – Samsung Electronics will demonstrate three key network technologies at Mobile World Congress 2015 in Barcelona, which will pave the way for 5G mobile communications. Each technology focuses on important aspects of the Radio Access Network (RAN) and involves networking innovations that will have a dramatic impact on the capabilities of commercial mobile networks.

“We consider 5G to be a transformation of how networks are constructed and how radio resources are used,” said Chang Yeong Kim, Head of DMC R&D Center at Samsung Electronics. “To support 100 times greater throughputs at a fraction of the latency, we need to consider more than just a single network component; we need to look at how everything works together. At the same time, the evolution toward 5G must be an incremental process, introducing new technologies in the short- and mid-term that can be tried, tested and proven on commercial networks.”

mmWave Wireless Backhaul



Figure A mmWave Wireless Backhaul Concept

Utilizing a 60 GHz spectrum, Samsung is rapidly nearing commercialization of a wireless backhaul solution that promises to support speeds of multi-Gbps—faster than legacy wireless backhaul solutions.

Samsung’s unique approach combines active and passive radio steering techniques to increase the effective range of a radio without exceeding the power output limits that exist in unlicensed bands throughout the world. An active antenna array enables a beamformed radio signal to be directed at a passive lens antenna, which further focuses the radio signal toward a fixed point—similar to a contact lens focusing light into the retina of the eye.

By actively focusing the radio signal into a precise and highly accurate beam, the solution overcomes many of the environmental issues that affect communications in the 60GHz band.

The technology is initially intended to target flexible small-cell deployments, where wireline backhaul may be expensive or impractical to implement.

Additionally, the technology is designed to be easy to deploy and maintain, taking advantage of a small, light-weight and modular design with separate radio, antenna and processing modules in each unit.

Meanwhile, the use of active beamforming reduces the need to regularly calibrate the antenna orientation, further reducing maintenance requirements.

With small cell deployments expected to be a significant focus in 2015, this technology will be a solid enabler for high capacity and better coverage with lower CAPEX and OPEX.

Full Dimension Multiple Input Multiple Output (FD-MIMO)

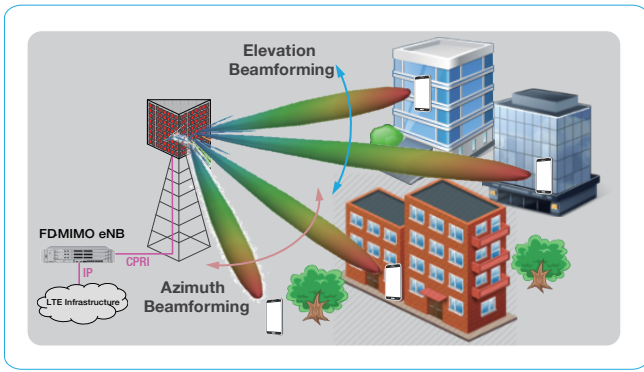

Figure B FD-MIMO Concept

With the introduction of FD-MIMO and 2D-array antenna technology, wireless signals can be adaptively beamformed to specific users in both horizontal and vertical domains.

Additionally, with the adoption of advanced digital signal processing schemes, an FD-MIMO antenna system can support higher-order multi-user MIMO (MU-MIMO) which delivers a multi-fold improvement in system performance compared to conventional MIMO systems.

The technology is ultimately designed to deliver a unique, targeted radio signal to more than eight users in a cell at a time. The innovative capabilities provided by FD-MIMO systems will also enable support for new deployment and operational scenarios, such as high-rise building support and multiple user services in crowded malls and stadiums.

Samsung is leading the standardization of 3GPP FD-MIMO in the upcoming Release 13 and exhibit this item at MWC 2015 includes an LTE Rel.13 pre-release eNodeB. It is characterized by its compact footprint with the 2D-array antenna, RF components, and baseband board being fully integrated.

mmWave Mobile Radio Access

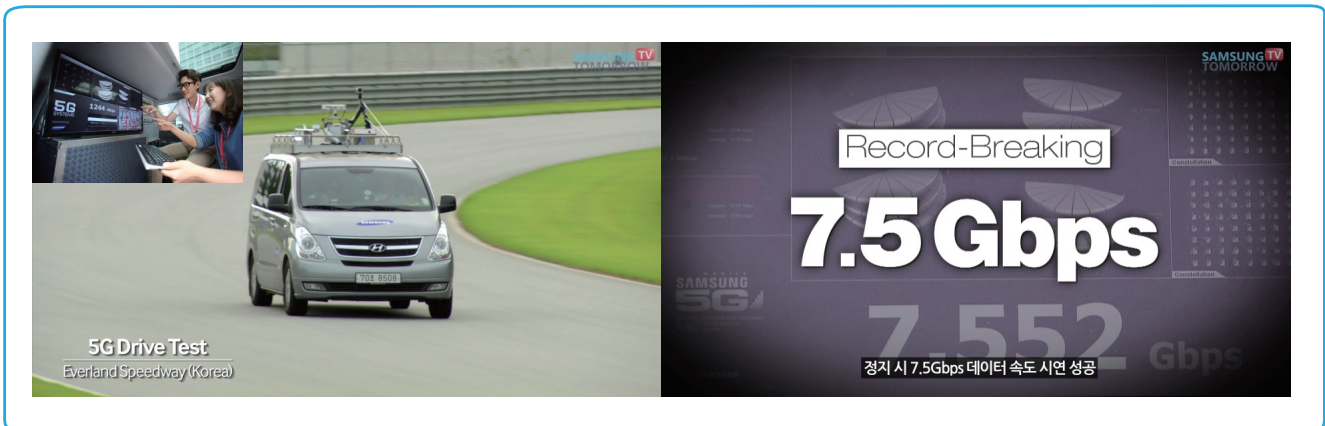

Figure C Samsung's 5G Test Result in October 2014

Samsung has made several critical steps toward demonstrating the viability and suitability of millimeter waves for the next generation of radio access technologies. The technology is expected to play an important role in delivering cost-effective gigabit data rates to users throughout an operator's mobile network.

In October 2014, Samsung announced the “world's first successful test” of mobile millimeter wave radio technology, establishing a throughput of 1.2 Gbps at 100 km/h, and establishing a new record for stationary communications of 7.5 Gbps.

The test utilized a licensed 28 GHz band and introduced Samsung's Hybrid Adaptive Array antenna technology. Samsung believes that research into technologies such as this represents one of several critical milestones toward meeting the goals of 5G technology, including peak throughputs that are 100 times faster than those of LTE, and latencies one tenth of those we experience today.