

Dangbei

Google TV

Atom
Smart Projector

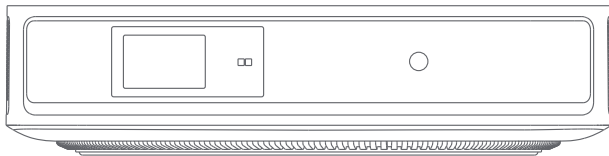

User Manual

Language

English	01-19
Deutsch	20-39
Français	40-59
Italiano	60-79
Español	80-99
日本語	100-119

Contents

Read before Use	01
Packing List	02
Projector Overview	03
Remote Control Overview	05
Getting Started	06
Network Settings	09
Focus Settings	09
Image Correction Settings	10
Bluetooth Speaker Mode	11
Google Assistant	11
Chromecast built-in™ & Screen Mirroring	12
Inputs	13
More Settings	13
Specifications	14
Troubleshooting	15
Important Precautions	17
Statement	18

Read before Use

Please read the product instructions carefully:

Thank you for purchasing and using these products.

For your safety and interests, please read the Product Instructions carefully before using the product.

About the Product Instructions:

The trademarks and names mentioned in the Product Instructions are the property of their respective owners.

All Product Instructions shown are for illustration purposes only. The actual product may vary due to product enhancements.

We shall not be liable for any personal injury, property damage, or other damages caused by the failure of the user to comply with the Product Instructions or precautions.

* Dangbei reserves the right to interpret and modify the Product Instructions.

Packing List

Before using this product, please check that all items are included in the box.

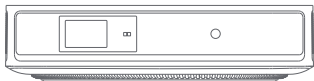

Projector



Remote Control
(batteries not included)



Power Adapter



Power Cable

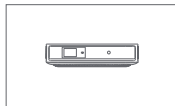

User Manual

Projector Overview

Overview and interface description.

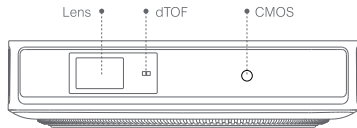

Front View

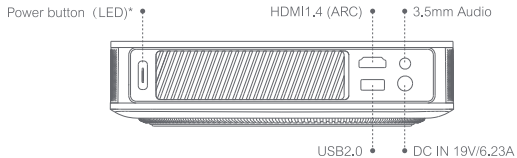

Rear View

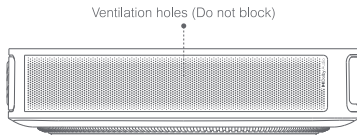

Left View

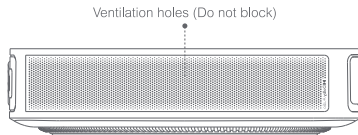

Right View



Top View

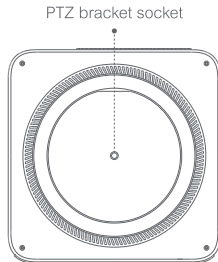

Bottom View

Power Button LED Indicator Guide		
Button	LED Status	Description
 Power button	On	Standby mode / Power on / Bluetooth speaker mode pairing successful / Power off
	Off	In projection
	Blinking	Firmware update / Bluetooth speaker mode pairing in progress

Remote Control Overview

- Open the battery compartment cover of the remote control.
- Install 2 AAA batteries (**not included**) *.
- Put back the battery compartment cover.

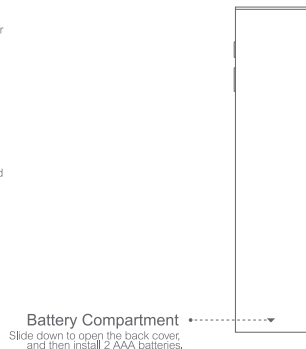
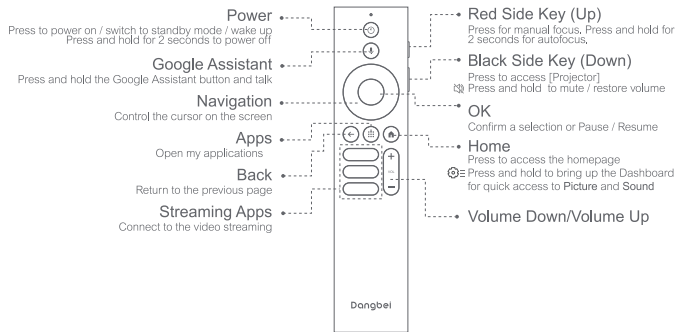

* Please insert new batteries according to the polarity indication.

Getting Started

1.Placement

Position the projector on a stable, flat surface in front of the projection surface. A flat and white projection surface is recommended. Please follow the instructions below to determine the distance between the projector and the projection surface, and the corresponding projection size:

Size	Screen (Length × Width)
60 inches	133 x 75 cm 4.36x2.46 ft
80 inches	177 x 100 cm 5.8x 3.28 ft
100 inches	221 x 124 cm 7.25 x 4.06 ft
120 inches	265 x 149 cm 8.69 x 4.88 ft



The best recommended projection size is 100 inches.

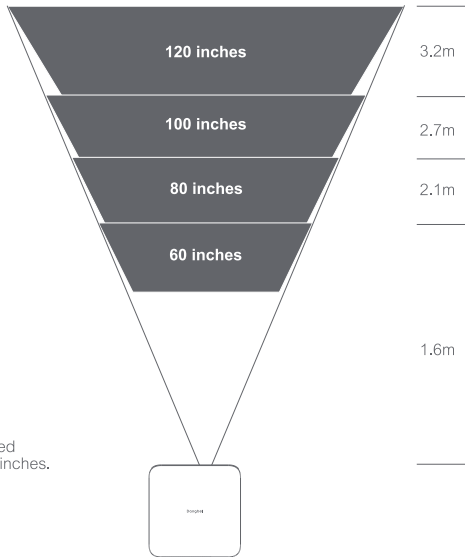

2. Power on

- ① Connect the projector to the power outlet.

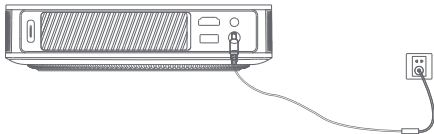

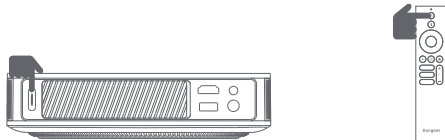

- ② Press the power button on the projector or remote control to turn on the projector.



3. Standby Mode / Power off

Press the power button on the projector or remote control to enter standby mode.
Press and hold the power button on the projector or remote control for 2 seconds to turn off the projector.

3.Remote Control Pairing

- Turn on the projector and wait for the Bluetooth pairing prompt on the screen.
- Bring the remote control within 10 cm / 0.33 ft of the projector.
- Simultaneously press and hold the  and  keys.
- Release the keys after the indicator light starts flashing.
- Wait until you hear two "beep" sounds, indicating a successful pairing.

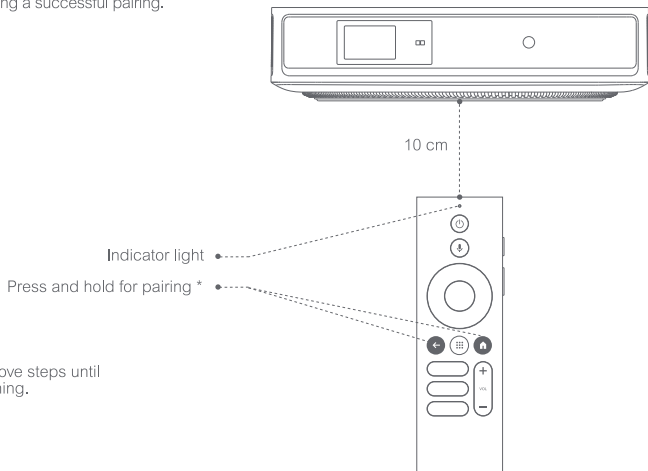

* If the pairing is unsuccessful, repeat the above steps until the remote control indicator light stops flashing.

Network Settings

- Go to [Settings], select [Network & Internet], and turn on Wi-Fi.
- Choose your network and enter the correct password.

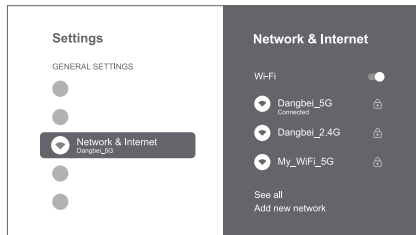

Focus Settings

Method 1: Press the red side key (up) for manual focus.

Press and hold for 2 seconds for autofocus.

Method 2: Go to [Projector], select [Focus], and choose either manual focus or autofocus.

Autofocus

Select [Auto Focus] to trigger the autofocus function.

The image will automatically become clear.

Manual focus

Select [Manual Focus] and use the navigation keys (up / down) on the remote control to adjust the focus distance and make the image clear.

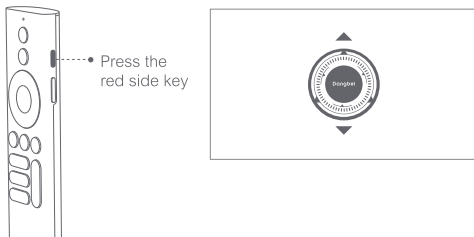
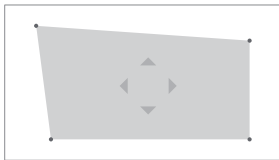

Image Correction Settings

1.Keystone Correction

- Go to [Projector] -- [Image Correction].
- Select [Auto Keystone Correction], and the screen will automatically be corrected.
- Select [Manual Keystone Correction], and use navigation keys to adjust the four points and the image shape.



2.Intelligent Screen Fit

- Go to [Projector] – [Image Correction], and turn on [Fit to Screen].
- Follow the on-screen instructions to automatically adjust the projected image to fit the screen.

3.Intelligent Obstacle Avoidance

- Go to [Projector] -- [Image Correction] – [Advanced], and turn on [Avoid Obstacles].
- Follow the on-screen instructions to automatically adjust the projected image to avoid any objects on the projection surface.

Bluetooth Speaker Mode

- Go to [Settings], select [Projector], and click on [Bluetooth speaker mode].
- Connect your phone to a device with the Bluetooth name containing "DBOD02". After modifying the device name, the Bluetooth name will also be synchronized accordingly.
- When you hear "Bluetooth connection successful", the projector can play music from your phone.
- Press and hold the  key on the remote control for 2 seconds to exit the [Bluetooth speaker mode].

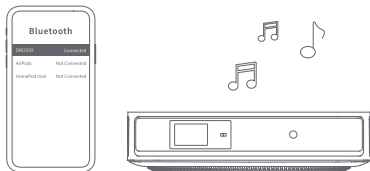

Google Assistant

Your TV is more helpful than ever. Use your voice to find movies, stream apps, play music and control the TV. Ask Google Assistant to find a specific title, search by genre, or get personalized recommendations. Even get answers on screen, control smart home devices, and more. Press the Google Assistant button on the remote to get started.

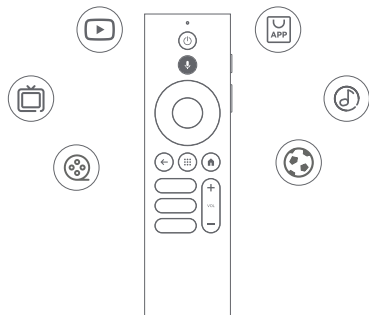

Chromecast built-in & Screen Mirroring

You can wirelessly cast movies, games, music, and your screen from your iOS, macOS, Android™, or Windows device to the projector. Please make sure that the projector and your device are connected to the same wireless network.

1.Chromecast built-in

To cast in-app content:

You can cast content from Chromecast-enabled apps such as YouTube and other streaming apps.

- 1.Connect your device and the projector to the same wireless network.
- 2.Open the streaming app on your device.
- 3.Play a video and tap the casting icon  on the video screen.
- 4.Select "DBOD02" to connect. The projector will display the video from your device.

*Due to copyright restrictions, certain content cannot be cast to the projector. You can stream the content on the projector by installing the same application on it.

2. Screen Mirroring via AirScreen

To cast the device screen:

You can project the entire screen from your device to the projector.

1. Ensure that both your device and the projector are connected to the same wireless network.
- 2.Install the AirScreen app on the projector.
- 3.Open the AirScreen app and follow the on-screen instructions to complete the process.

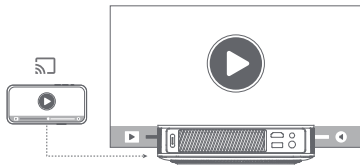

Inputs

- Go to [Inputs] -- HDMI/HOME/USB.
- Watch the content from the different signal sources.

*This product's HDMI interface is HDMI 1.4 and does not support 4K video signal input.

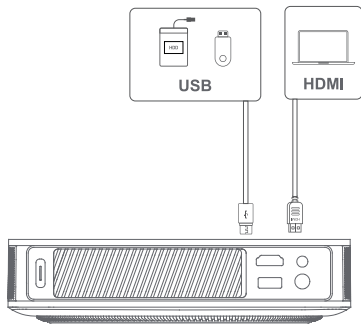

More Settings

1.Color Temperature

Go to [Settings] – [Display&Sounds] -- [Picture] -- [Color Temperature] to select from [Standard/Warm/Eye-care].

2.Projection Mode

Go to [Settings] -- [Projector]-- [Advanced Settings] -- [Projection Mode] to choose the placement method of the projector.

3.Zoom

Go to [Settings] -- [Projector] -- [Image Correction] -- [Image Adaption] to decrease the image size from 100% to 50%.

4.3D Mode

Before enabling 3D mode, go to [Settings] – [Projector] – [Image Correction], and click [Reset to Default Image] to restore the image to its default state. Go to [Settings] -- [Picture] – [3D Mode] to enable 3D mode.

*It is recommended to disable the [Auto Keystone Correction After Movement] feature when enabling 3D mode to avoid altering the image from its default state after moving the projector, which could prevent the use of 3D mode.

5.System & Product Info

Go to [Settings] – [System] – [About] to check the System & Product information.

Specifications

Display Technology	0.33 in, DLP
Display Resolution	1920 x 1080
Throw Ratio	1.2:1
Speakers	2 x 5 W

Bluetooth Version	5.1
WI-FI	Dual Frequency 2.4/5.0 GHz
Dimensions (L x W x H)	195 × 195 × 47.5 mm 7.68 x 7.68 x 1.87 inches
Weight	1.28kg /2.82lb

Troubleshooting

1.No audio output

- a. Check if you have double-clicked the black side key on the remote control to put the projector in mute mode.
- b. Check if the projector interface "HDMI ARC" or Bluetooth is connected to an external audio device.

2. No image output

- a. Press the power button located on the rear of the projector. The power button indicator light will turn off if the projector enters projection mode successfully.
- b. Ensure that the power adaptor has power output.

3. No network

- a. Enter settings, and check the network connection status in the network option.
- b. Ensure that the network cable is correctly inserted to the projector interface "LAN".
- c. Ensure that the router is correctly configured.

4. Blurry Image

- a. Adjust the focus or keystone.
- b. The projector and screen/wall must be positioned with an effective distance.
- c. Projector lens is not clean.

5. Non-rectangular Image

- a. Place the projector perpendicular to the screen/wall if keystone correction function is not used.
- b. Use the keystone correction function to adjust the display.

6. Automatic keystone correction failed

- a. Ensure that the Camera/TOF on the front panel is not blocked or dirty.
- b. The best automatic keystone correction distance is 2.0-4.0m, horizontal $\pm 30^\circ$.

7. Autofocus failure

- a. Ensure that the Camera/TOF on the front panel is not blocked or dirty.
- b. The best autofocus distance is 2.0–4.0m, horizontal $\pm 20^\circ$.

8. Smart Eye Protection failed

- a. Ensure that the Camera/TOF on the front panel is not blocked or dirty
- b. The optimal sensing range is located around the center of the image. Being too close to the edges may result in the eye protection feature not triggering.

9. Intelligent Screen Fit failure

- a. Ensure that the projector is correctly positioned, so that the projected image extends beyond the edges of the screen.
- b. Ensure that the projection screen has a colored border/frame on all four sides, so that the projector can recognize the frame.
- c. Ensure that the red box pattern is within the screen frame, and is not blocked.

10. The Remote Control is unresponsive

- a. Ensure that the remote control is successfully paired via Bluetooth. If the pairing is successful, the LED light will flash once when you press any button. When you press and hold any button, the LED light will remain solid.
- b. If the pairing is unsuccessful, the LED light will flash three times when you press any button. When you press and hold any button, the LED light will flash three times and then remain solid.
- c. Check if the power indicator is still on without pressing any buttons. If it is, check the status of the remote control buttons to ensure they are not being pressed.
- d. Ensure that there are no interferences or obstructions between the projector and remote control.
- e. Check the battery and installation polarity.

11. Connect the Bluetooth devices

Enter settings, open the Bluetooth option to check the Bluetooth device list, and connect the device.

12. Others

Please feel free to contact us at support@dangbei.com

Important Precautions

- Do not look directly at the projection beam with your eyes, because the strong beam may harm your eyes. RG2 IEC 60825-1:2014
- Do not block or cover the heat dissipation holes of the device to avoid affecting the heat dissipation of the internal parts, and damaging the device.
- Keep away from humidity, exposure, high temperature, low pressure, and magnetic environments.
- Do not place the device in areas susceptible to excessive dust and dirt.
- Place the device in a flat and stable station, and do not place the device on a surface that is prone to vibration.
- Do not allow children to handle the device without supervision.
- Do not place heavy or sharp objects on the device.
- Avoid extreme vibrations, because these may damage the internal components.
- Please use the correct type of battery for the remote control.
- Only use attachments/accessories specified or provided by the manufacturer (such as the exclusive power adapter, bracket, etc.).
- Do not disassemble the device. The device should only be repaired by staff authorized by the manufacturer.
- Place and use the device in a 5-35°C environment.
- The metal casing is coated with insulating paint.
- The plug is considered as a disconnected device of the adapter.
- The adapter should be installed near the equipment, and should be easily accessible.
- Protect the power cord from being walked on or pinched, particularly at the plugs, convenience receptacles, and the point where this exits from the device.
- Unplug this device if there are lightning storms or when unused for a long period of time.
- Where the power plug or an appliance coupler is used to disconnect the device, the disconnected device would remain readily operable.
- Never touch the power cable or power connector with wet hands.
- Risk of explosion if battery is replaced by an incorrect type. Dispose of used batteries according to local regulations.

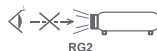

Statement

Google TV is the name of this device's software experience and a trademark of Google LLC. Google, YouTube and Chromecast built-in are trademarks of Google LLC.

This equipment has been tested and found to comply with the limits for a Class B digital device, pursuant to Part 15 of the FCC Rules. These limits are designed to provide reasonable protection against harmful interference in a residential installation.

This equipment generates uses and can radiate radio frequency energy and, if not installed and used in accordance with the instructions, may cause harmful interference to radio communications. However, there is no guarantee that interference will not occur in a particular installation. If this equipment does cause harmful interference to radio or television reception, which can be determined by turning the equipment off and on, the user is encouraged to try to correct the interference by one or more of the following measures:

- Reorient or relocate the receiving antenna.
- Increase the separation between the equipment and receiver.
- Connect the equipment to an outlet on a circuit different from that to which the receiver is connected.
- Consult the dealer or an experienced radio/TV technician for help.

Changes or modifications not expressly approved by the party responsible for compliance could void the user's authority to operate the equipment.

We declare that this device is in compliance with the essential requirements and other relevant provisions of Directive 2014/53/EU. Satisfies all the technical regulations applicable to the product within the scope of UK Radio Equipment Regulations (SI 2017/1206); UK Electrical Equipment (Safety) Regulations (SI 2016/1101); and UK Electromagnetic Compatibility Regulations (SI 2016/1091). This device operating frequency: 2402-2480MHz (EIRP < 20dBm), 2412-2472MHz (EIRP < 20dBm), 5150~5250MHz (EIRP < 23dBm), 5250~5350MHz (EIRP < 20dBm), 5470~5725MHz (EIRP < 27dBm), 5725~5850MHz (EIRP < 13.98dBm).

 We declares that this device is in compliance with the essential requirements and other relevant provisions of Directive 2014/53/EU.

 Satisfies all the technical regulations applicable to the product within the scope of UK Radio Equipment Regulations (SI 2017/1206); UK Electrical Equipment (Safety) Regulations (SI 2016/1101); and UK Electromagnetic Compatibility Regulations (SI 2016/1091).



Manufactured under license from Dolby Laboratories. Dolby, Dolby Audio, and the double-D symbol are trademarks of Dolby Laboratories Licensing Corporation.

NETFLIX

Netflix is a trademark of Netflix, Inc.

THIS DEVICE COMPLIES WITH DHHS RULES 21 CFR CHAPTER I SUBCHAPTER J.
CAN ICES-3 (B)/NMB-3 (B)

This Class B digital apparatus complies with Canadian ICES-003.

Cet appareil numérique de classe B est conforme à la norme canadienne ICES-003.

This device contains licence-exempt transmitter(s)/receiver(s) that comply with Innovation, Science and Economic Development Canada's licence-exempt RSS(s). Operation is subject to the following two conditions:

- (1) This device may not cause interference.
- (2) This device must accept any interference, including interference that may cause undesired operation of the device

L'émetteur/récepteur exempt de licence contenu dans le présent appareil est conforme aux CNR d'Innovation, Sciences et Développement économique Canada applicables aux appareils radio exempts de licence. L'exploitation est autorisée aux deux conditions suivantes :

- 1.L'appareil ne doit pas produire de brouillage;
- 2.L'appareil doit accepter tout brouillage radioélectrique subi, même si le brouillage est susceptible d'en compromettre le fonctionnement.

For projectors only

The distance between user and products should be no less than 20cm.

La distance entre l'utilisateur et le produit ne doit pas être inférieure à 20 cm.

5150-5350MHz band is restricted to indoor use only.

La bande de 5150-5350MHz est réservée à l'usage intérieur.



WARNING: This product can expose you to Lead, which is known to the State of California to cause cancer and birth defects or other reproductive harm. For more information go to www.P65Warnings.ca.gov

Sprache

English	01-19
Deutsch	20-39
Français	40-59
Italiano	60-79
Español	80-99
日本語	100-119

Inhalt

Vor gebrauch lesen	21
Lieferumfang	22
Projektorübersicht	23
Überblick über die Fernbedienung	25
Erste Schritte	26
Netzwerkeinstellungen	29
Einstellung des Fokus	29
Bildkorrektureinstellungen	30
Bluetooth-Lautsprechermodus	31
Google Assistant	31
Chromecast built-in & Screen Mirroring	32
Eingangsquellen	33
Weitere Einstellungen	33
Technische Daten	34
Fehlersuche	34
Wichtige Vorsichtsmaßnahmen	37
Erklärung	38

Vor gebrauch lesen

Bitte lesen Sie die Produkthanweisungen sorgfältig durch:

Wir danken Ihnen für den Kauf und die Verwendung unserer Produkte.

Für Ihre Sicherheit und zu Ihrer Information, lesen Sie bitte die Anleitung sorgfältig durch, bevor Sie das Produkt verwenden.

Über die Produkthanweisungen:

Alle in den Produkthanweisungen erwähnten Marken und Namen sind Eigentum der jeweiligen Inhaber.

Alle abgebildeten Produktabbildungen dienen nur zu Illustrationszwecken. Das tatsächliche Produkt kann aufgrund von Produktverbesserungen abweichen.

Wir haften nicht für Personen-, Sach- oder sonstige Schäden, die durch die Nichtbeachtung der Produkthanweisungen bzw. Vorsichtsmaßnahmen seitens des Benutzers verursacht werden.

* Dabei behält sich das Recht zur Auslegung und Änderung der Produkthanweisungen vor.

Lieferumfang

Before using this product, please check that all items are included in the box.

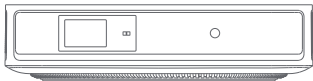

Projektor



Fernbedienung
(batterien nicht enthalten)

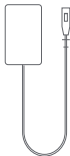

Netzteil



Netzkabel

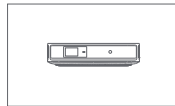

Bedienungsanleitung

Projektorübersicht

Übersicht und Schnittstellenbeschreibung.

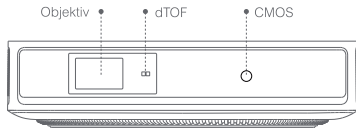

Vorderansicht

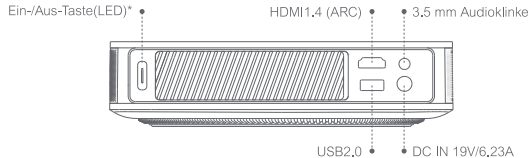

Rückansicht

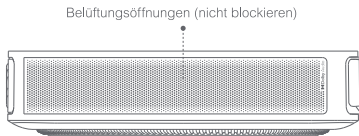

Ansicht links

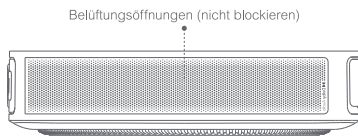

Ansicht rechts



Draufsicht

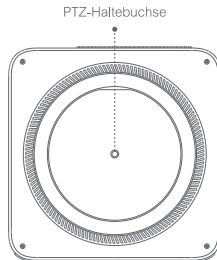

Untersicht

LED-Statusanzeige der Ein-/Aus-Taste		
Taste	LED-Status	Beschreibung
 Ein-/Aus-Taste	Ein	Bereitschaftsmodus / Einschalten / Bluetooth-Lautsprecher-Modus erfolgreich gekoppelt / Ausschalten
	Aus	In Projektion
	Blinkt	Firmware-Update / Bluetooth-Lautsprecher-Modus wird gekoppelt

Überblick über die Fernbedienung

- Öffnen Sie die Abdeckung des Batteriefachs an der Fernbedienung.
- Legen Sie 2 AAA-Batterien ein (**nicht im Lieferumfang enthalten**) *.
- Schließen Sie die Abdeckung des Batteriefachs wieder.

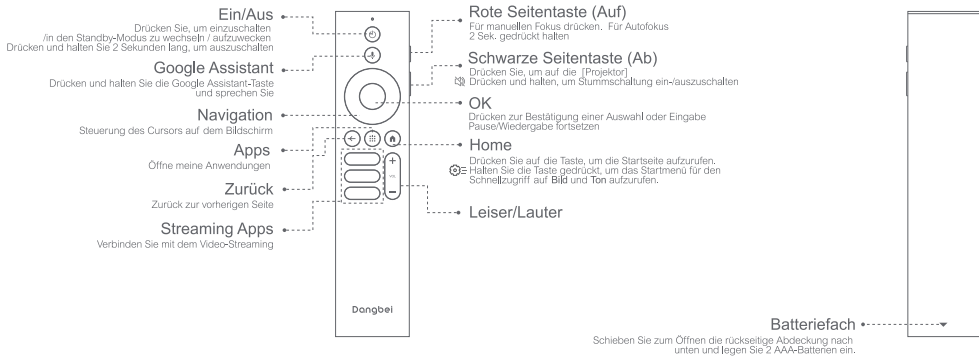

* Bitte legen Sie neue Batterien entsprechend der Polaritätskennzeichnung ein.

Erste Schritte

1. Aufstellung

Stellen Sie den Projektor auf eine stabile, ebene Fläche vor der Projektionsfläche. Es wird eine glatte, weiße Projektionsfläche empfohlen. Bitte befolgen Sie die nachstehenden Anweisungen zur Bestimmung des Abstands zwischen Projektor und Projektionsfläche sowie der entsprechenden Projektionsgröße:

Größe	Bildfläche (Länge × Breite)
60 Zoll	133 x 75 cm 4.36x2.46 ft
80 Zoll	177 x 100 cm 5.8x 3.28 ft
100 Zoll	221 x 124 cm 7.25 x 4.06 ft
120 Zoll	265 x 149 cm 8.69 x 4.88 ft



Die beste empfohlene Projektionsgröße ist 100 Zoll.

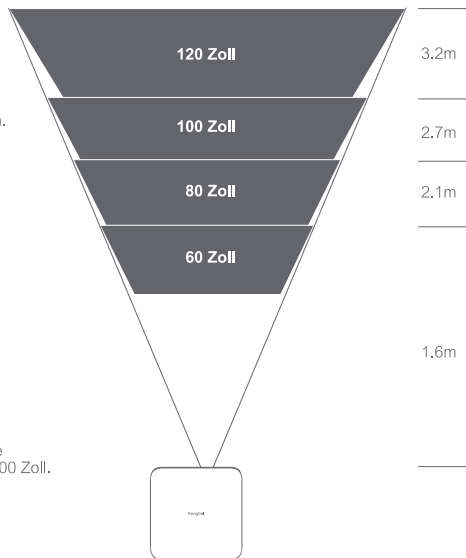

2.Einschalten

- ① Schließen Sie den Projektor an die Steckdose an.

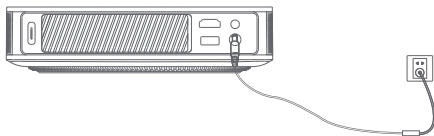

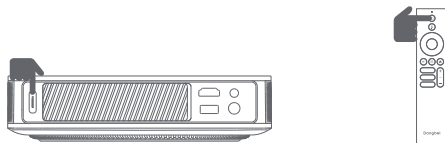

- ② Drücken Sie die Ein-/Aus-Taste am Projektor oder Fernbedienung, um den Projektor einzuschalten.



3.Standby-Modus / Ausschalten

Drücken Sie die Ein-/Aus-Taste am Projektor oder der Fernbedienung, um in den Standby-Modus zu wechseln.
Halten Sie die Ein-/Aus-Taste am Projektor oder der Fernbedienung 2 Sekunden lang gedrückt, um den Projektor auszuschalten.

3.Kopplung mit der Fernbedienung

- Schalten Sie den Projektor ein und warten Sie auf die Aufforderung zur Bluetooth-Kopplung auf dem Bildschirm.
- Halten Sie die Fernbedienung in einer Entfernung von 10 cm / 0,33 ft zum Projektor.
- Halten Sie gleichzeitig die Tasten  und  gedrückt.
- Lassen Sie die Tasten los, wenn die Kontrollanzeige zu blinken beginnt.
- Warten Sie, bis zwei „Pieptöne“ zur Bestätigung der erfolgreichen Kopplung ausgegeben werden.

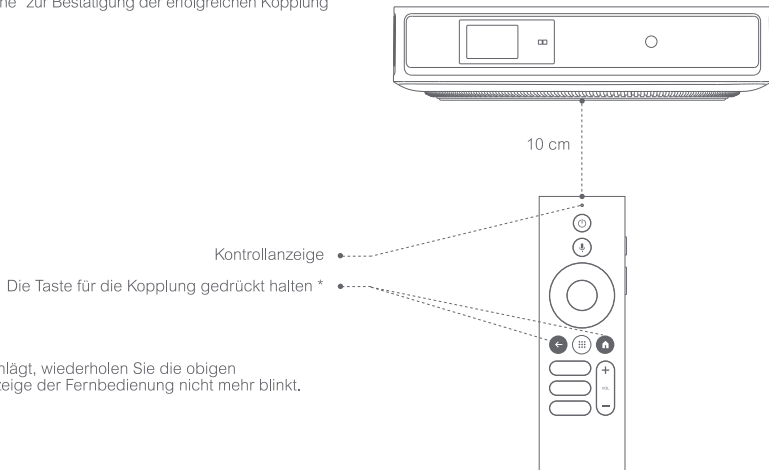

* Wenn die Kopplung fehlschlägt, wiederholen Sie die obigen Schritte, bis die Kontrollanzeige der Fernbedienung nicht mehr blinkt.

Netzwerkeinstellungen

- Gehen Sie auf [Einstellungen], wählen Sie [Netzwerk & Internet], und schalten Sie das WLAN ein.
- Wählen Sie Ihr Netzwerk aus und geben Sie das richtige Passwort ein.



Einstellung des Fokus

Method 1: Drücken Sie für den manuellen Fokus die rote Seitentaste (Auf). Halten Sie für den Autofokus die Taste für 2 Sek. gedrückt.

Method 2: Gehen Sie auf [Projektor], wählen Sie [Fokus], und wählen Sie entweder manuellen Fokus oder Autofokus.

Autofocus

Wählen Sie [Autofokus], um die Autofokusfunktion zu aktivieren. Das Bild wird automatisch scharf gestellt.

Manual focus

Wählen Sie [Manueller Fokus] und verwenden Sie die Navigationstasten (Auf/Ab) der Fernbedienung, um den Fokusabstand zu regulieren und das Bild scharf zu stellen.



Bildkorrektureinstellungen

1. Trapezkorrektur

- Gehen Sie auf [Projektor] – [Bildkorrektur].
- Wählen Sie [Automatische Trapezkorrektur], und der Bildschirm wird automatisch korrigiert.
- Wählen Sie [Manuelle Trapezkorrektur], und verwenden Sie die Navigations-Tasten, um die vier Punkte und die Bildform anzupassen.

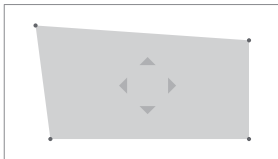

2. Intelligente Bildgrößenanpassung

- Gehen Sie auf [Projektor] – [Bildkorrektur] und aktivieren Sie [An Projektionsfläche anpassen].
- Follow the on-screen instructions to automatically adjust the projected image to fit the screen.

3. Intelligente Hindernisvermeidung

- Gehen Sie auf [Projektor] – [Image Correction] -- [Erweitert] und aktivieren Sie [Hindernisvermeidung].
- Befolgen Sie die Anweisungen auf der Projektionsfläche, um das projizierte Bild automatisch so anzupassen, dass Objekte auf der Projektionsfläche gemieden werden.

Bluetooth-Lautsprechermodus

- Gehen Sie auf [Einstellungen], wählen Sie [Projektor] und klicken Sie auf [Bluetooth-Lautsprechermodus].
- Verbinden Sie Ihr Handy mit dem Gerät mit Bluetooth-Namen "DBOD02". Nachdem Sie den Gerätenamen geändert haben, wird auch der Bluetooth-Name entsprechend synchronisiert.
- Wenn Sie „Bluetooth-Verbindung erfolgreich“ hören, kann der Projektor Musik von Ihrem Handy wiedergeben.
- Halten Sie die -Taste auf der Fernbedienung für 2 Sek. gedrückt, um den [Bluetooth-Lautsprechermodus] zu beenden.

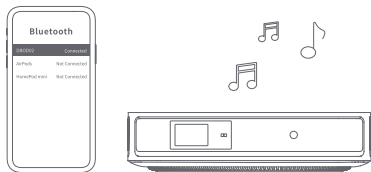

Google Assistant

Ihr Fernseher ist jetzt noch hilfreicher. Nutzen Sie Ihre Stimme, um Filme zu finden, Apps zu streamen, Musik abzuspielen und den Fernseher zu steuern. Fragen Sie den Google Assistant nach einem bestimmten Titel, suchen Sie nach Genre oder erhalten Sie personalisierte Empfehlungen. Sie können sogar Antworten auf dem Bildschirm erhalten, Smart-Home-Geräte steuern und vieles mehr. Drücken Sie die Google Assistant-Taste auf der Fernbedienung, um loszulegen.

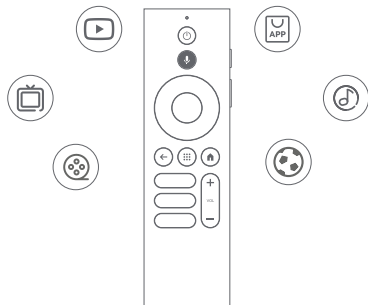

Chromecast built-in & Screen Mirroring

Sie können Filme, Spiele, Musik und Ihren Bildschirm von Ihrem iOS-, macOS-, Android™- oder Windows-Gerät drahtlos auf den Projektor übertragen.

*Stellen Sie sicher, dass der Projektor und Ihr Gerät mit demselben drahtlosen Netzwerk verbunden sind.

1. Chromecast built-in

Um Inhalte aus der App zu übertragen:

Sie können Inhalte von Chromecast-fähigen Apps wie YouTube und anderen Streaming-Apps übertragen.

1. Verbinden Sie Ihr Gerät und den Projektor mit demselben drahtlosen Netzwerk.
2. Öffnen Sie die Streaming-App auf Ihrem Gerät.
3. Spielen Sie ein Video ab und tippen Sie auf das Übertragungssymbol  auf dem Video-Bildschirm.
4. Wählen Sie "DBOD02" aus, um eine Verbindung herzustellen. Der Projektor zeigt das Video von Ihrem Gerät an.

*Aufgrund von Urheberrechtsbeschränkungen kann bestimmter Inhalt nicht auf den Projektor übertragen werden. Sie können den Inhalt auf dem Projektor streamen, indem Sie dieselbe Anwendung darauf installieren.

2. Bildschirmspiegelung über AirScreen

Um den Bildschirm des Geräts zu übertragen:

Sie können den gesamten Bildschirm von Ihrem Gerät auf den Projektor projizieren.

1. Stellen Sie sicher, dass sowohl Ihr Gerät als auch der Projektor mit demselben drahtlosen Netzwerk verbunden sind.
2. Installieren Sie die AirScreen-App auf dem Projektor.
3. Öffnen Sie die AirScreen-App und befolgen Sie die Anweisungen auf dem Bildschirm, um den Vorgang abzuschließen.

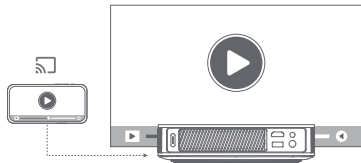

Eingangsquelle

- Gehen Sie auf [Eingänge] -- HDMI/HOME/USB.
- Schauen Sie Inhalte von verschiedenen Signalquellen.

*Die HDMI-Schnittstelle dieses Produkts entspricht HDMI 1.4 und unterstützt keinen 4K-Videoeingang.

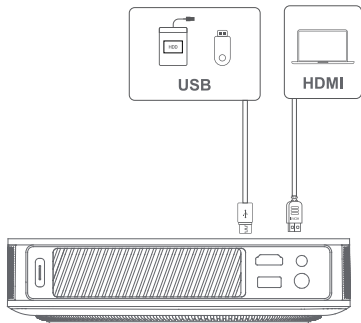

Weitere Einstellungen

1. Farbtemperatur

Gehen Sie auf [Einstellungen] – [Display & Ton] -- [Bild] -- [Farbtemperatur], um zwischen [Standard/Warm/Augenschonend] auszuwählen.

2. Projektionsmodus

Gehen Sie auf [Einstellungen] – [Projektor] – [Erweiterte Einstellungen] -- [Projektionsmodus], um die Aufstellungsmethode des Projektors auszuwählen.

3. Zoom

Gehen Sie auf [Einstellungen] – [Projektor] – [Bildkorrektur] – [Bildanpassung] – [Zoom], um die Bildgröße von 100% auf 50% zu verringern.

4. 3D-Modus

Vor der Aktivierung des 3D-Modus, gehen Sie auf [Einstellungen] -- [Projektor] – [Bildkorrektur] und klicken Sie auf [Auf Standardbild zurücksetzen], um das Bild auf seine Standardeinstellungen zurückzusetzen.
Gehen Sie zu Aktivierung des 3D-Modus auf [Einstellungen] – [Bild] – [3D-Modus].
*Bei aktiviertem 3D-Modus wird empfohlen, die Funktion [Automatische Trapezkorrektur nach Bewegung des Geräts] zu deaktivieren, um zu vermeiden, dass das Bild nach dem Bewegen des Projektors die Standardeinstellung ändert, was die weitere Anwendung des 3D-Modus verhindern könnte.

5. System- und Produktinformationen

Gehen Sie auf [Einstellungen] – [System] – [Info], um die System- und Produktinformationen zu prüfen.

Technische Daten

Display-Technologie	0.33 Zoll, DLP	Bluetooth-Version	5.1
Bildauflösung	1920 x 1080	WI-FI	Doppelfrequenz 2.4/5.0 GHz
Projektionsverhältnis	1.2:1	Abmessungen (L x B x H)	195 × 195 × 47.5 mm 7.68 x 7.68 x 1.87 Zoll
Lautsprecher	2 x 5 W	Gewicht	1.28kg /2.82lb

Fehlersuche

1. Keine Audioausgabe

- a. Überprüfen Sie, ob Sie die schwarze Seitentaste auf der Fernbedienung doppelt gedrückt haben, da dadurch der Projektor stummgeschaltet werden kann.
- b. Prüfen Sie, ob die Projektorschchnittstelle „HDMI ARC“ oder das Bluetooth mit einem externen Audiogerät verbunden ist.

2. Keine Bildausgabe

- a. Drücken Sie die Ein-/Aus-Taste auf der Rückseite des Projektors. Die Anzeigeleuchte der Ein-/Aus-Taste erlischt, wenn der Projektor erfolgreich in den Projektionsmodus wechselt.
- b. Vergewissern Sie sich, dass das Netzteil Strom ausgibt.

3. Kein Netzwerk

- a. Rufen Sie die Einstellungen auf und überprüfen Sie den Netzwerkverbindungsstatus unter der Option Netzwerk.
- b. Achten Sie darauf, dass das Netzwerkkabel ordnungsgemäß an der Projektorschchnittstelle „LAN“ angeschlossen ist.
- c. Stellen Sie sicher, dass der Router ordnungsgemäß konfiguriert ist.

4. Verschwommenes Bild

- a. Nehmen Sie Einstellungen für den Fokus bzw. die Trapezkorrektur vor.
- b. Der Projektor und die Leinwand/Wand müssen sich in einem ordnungsgemäßen Abstand zueinander befinden.
- c. Das Objektiv des Projektors ist nicht sauber.

5. Nicht rechtwinkliges Bild

- a. Falls die Trapezkorrekturfunktion nicht verwendet wird, stellen Sie den Projektor senkrecht zur Leinwand/Wand auf.
- b. Verwenden Sie die Funktion Trapezkorrektur zur Anpassung der Bildfläche.

6. Automatische Trapezkorrektur schlägt fehl

- a. Vergewissern Sie sich, dass die Kamera/TOF an der Vorderseite nicht blockiert oder verschmutzt ist.
- b. Der beste Abstand für die automatische Trapezkorrektur beträgt 2,0–4,0m, horizontal $\pm 30^\circ$.

7. Autofokus-Fehler

- a. Stellen Sie sicher, dass die Kamera/TOF an der Vorderseite nicht blockiert oder verschmutzt ist.
- b. Die beste Entfernung für die Funktion Autofokus beträgt 2,0–4,0m, horizontal $\pm 20^\circ$.

8. Fehler intelligenter Augenschutz

- a. Stellen Sie sicher, dass die Kamera/TOF an der Vorderseite nicht blockiert oder verschmutzt ist.
- b. Der optimale Erfassungsbereich befindet sich in der Bildmitte. Falls Sie sich zu nahe am Bildrand befinden, könnte die Augenschutzfunktion möglicherweise nicht ausgelöst werden.

9. Fehler bei der intelligenten Bildgrößenanpassung

- a. Achten Sie darauf, dass der Projektor richtig aufgestellt ist, so dass das projizierte Bild über die Kanten der Projektionsfläche hinausreicht.
- b. Stellen Sie sicher, dass die Projektionsfläche an allen vier Seiten einen farbigen Rand/Rahmen hat, damit der Projektor den Rahmen erkennen kann.
- c. Vergewissern Sie sich, dass sich das rote Kastenmuster innerhalb der Projektionsfläche befindet und nicht blockiert wird.

10. Die Fernbedienung reagiert nicht

- a. Stellen Sie sicher, dass die Fernbedienung erfolgreich über Bluetooth gekoppelt ist. Bei erfolgreicher Kopplung blinkt die LED-Anzeige einmal, wenn Sie eine beliebige Taste drücken. Beim Gedrückthalten einer beliebigen Taste, leuchtet die LED-Anzeige konstant.
- b. Bei einer fehlgeschlagenen Kopplung, blinkt die LED-Anzeige dreimal, sobald Sie eine beliebige Taste drücken. Beim Gedrückthalten einer beliebigen Taste, blinkt die LED-Leuchte dreimal und leuchtet daraufhin konstant.
- c. Überprüfen Sie, ob die Betriebsanzeige eingeschaltet bleibt, ohne dass Sie irgendwelche Tasten drücken. Wenn dies der Fall ist, prüfen Sie, ob Tasten auf der Fernbedienung blockiert sind.
- d. Achten Sie darauf, dass sich keine Störquellen oder Hindernisse zwischen dem Projektor und der Fernbedienung befinden.
- e. Überprüfen Sie die Batterieleistung sowie die Polarität der eingelegten Batterien.

10. Verbinden von Bluetooth-Geräten

Gehen Sie auf Einstellungen, öffnen Sie die Bluetooth-Option, um die Liste der Bluetooth-Geräte aufzurufen und verbinden Sie das Gerät.

12. Sonstiges

Bitte kontaktieren Sie uns unter support.eu@dangbei.com

Wichtige Vorsichtsmaßnahmen

- Blicken Sie nicht direkt in den Projektionsstrahl, der starke Lichtstrahl könnte Augenschäden verursachen. RG2 IEC 60825-1:2014
 - Blockieren oder decken Sie nicht die Wärmeabgabeöffnungen des Geräts ab, um die Wärmeabführung der internen Teile nicht zu beeinträchtigen und das Gerät nicht zu beschädigen.
 - Halten Sie das Gerät vor Feuchtigkeit, hohen Temperaturen, niedrigem Druck und magnetischen Umgebungen fern.
 - Stellen Sie das Gerät nicht an Orten auf, die anfällig für eine übermäßige Staub- und Schmutzansammlung sind.
 - Stellen Sie das Gerät auf einer ebenen und stabilen Fläche auf und nicht auf einer Oberfläche, die zu Vibrationen neigt.
 - Erlauben Sie Kindern nicht, das Gerät unbeaufsichtigt zu benutzen.
 - Stellen Sie keine schweren oder scharfen Gegenstände auf das Gerät.
 - Vermeiden Sie extreme Erschütterungen, da diese die internen Komponenten beschädigen könnten.
 - Bitte verwenden Sie den richtigen Batterietyp für die Fernbedienung.
 - Verwenden Sie nur vom Hersteller angegebenes oder mitgeliefertes Zubehör (z. B. das exklusive Netzteil, die Halterung usw.).
 - Das Gerät darf nicht zerlegt werden. Das Gerät darf nur durch vom Hersteller autorisiertes Personal repariert werden.
 - Betreiben Sie das Gerät in einer Betriebsumgebung von 5–35°C.
 - Das Metallgehäuse ist mit isolierender Farbe beschichtet.
 - Der Stecker wird als ein vom Netzteil getrenntes Gerät betrachtet.
 - Das Netzteil muss sich in der Nähe des Geräts befinden und leicht zugänglich sein.
 - Zum Schutz des Netzkabels, positionieren Sie es nicht in einer Weise, dass darauf getreten oder es eingeklemmt werden kann, insbesondere an den Steckern, den Steckdosen und an der Geräteaustrittsstelle.
 - Trennen Sie das Gerät bei einem Gewitter oder längerer Nichtbenutzung vom Stromnetz ab.
 - Falls die Steckdose oder eine Gerätesteckvorrichtung zum Abtrennen des Geräts verwendet wird, sollten Sie sicherstellen, dass Sie jederzeit auf den Stecker zugreifen können.
 - Fassen Sie das Netzkabel oder den Netzstecker niemals mit nassen Händen an.
 - Explosionsgefahr, wenn die Batterie durch einen falschen Typ ersetzt wird.
- Entsorgen Sie verbrauchte Batterien gemäß den örtlichen Vorschriften.

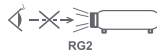

Erklärung

Google TV is the name of this device's software experience and a trademark of Google LLC.
Google, YouTube and Chromecast built-in are trademarks of Google LLC.

This equipment has been tested and found to comply with the limits for a Class B digital device, pursuant to Part 15 of the FCC Rules. These limits are designed to provide reasonable protection against harmful interference in a residential installation.

This equipment generates uses and can radiate radio frequency energy and, if not installed and used in accordance with the instructions, may cause harmful interference to radio communications. However, there is no guarantee that interference will not occur in a particular installation. If this equipment does cause harmful interference to radio or television reception, which can be determined by turning the equipment off and on, the user is encouraged to try to correct the interference by one or more of the following measures:

- Reorient or relocate the receiving antenna.
- Increase the separation between the equipment and receiver.
- Connect the equipment to an outlet on a circuit different from that to which the receiver is connected.
- Consult the dealer or an experienced radio/TV technician for help.

Changes or modifications not expressly approved by the party responsible for compliance could void the user's authority to operate the equipment.

We declare that this device is in compliance with the essential requirements and other relevant provisions of Directive 2014/53/EU. Satisfies all the technical regulations applicable to the product within the scope of UK Radio Equipment Regulations (SI 2017/1206); UK Electrical Equipment (Safety) Regulations (SI 2016/1101); and UK Electromagnetic Compatibility Regulations (SI 2016/1091). This device operating frequency: 2402-2480MHz (EIRP < 20dBm), 2412-2472MHz (EIRP < 20dBm), 5150~5250MHz (EIRP < 23dBm), 5250~5350MHz (EIRP < 20dBm), 5470~5725MHz (EIRP < 27dBm), 5725~5850MHz (EIRP < 13.98dBm).

 We declares that this device is in compliance with the essential requirements and other relevant provisions of Directive 2014/53/EU.

 Satisfies all the technical regulations applicable to the product within the scope of UK Radio Equipment Regulations (SI 2017/1206); UK Electrical Equipment (Safety) Regulations (SI 2016/1101); and UK Electromagnetic Compatibility Regulations (SI 2016/1091).



Manufactured under license from Dolby Laboratories. Dolby, Dolby Audio, and the double-D symbol are trademarks of Dolby Laboratories Licensing Corporation.

NETFLIX

Netflix is a trademark of Netflix, Inc.

THIS DEVICE COMPLIES WITH DHHS RULES 21 CFR CHAPTER I SUBCHAPTER J.
CAN ICES-3 (B)/NMB-3 (B)

This Class B digital apparatus complies with Canadian ICES-003.

Cet appareil numérique de classe B est conforme à la norme canadienne ICES-003.

This device contains licence-exempt transmitter(s)/receiver(s) that comply with Innovation, Science and Economic Development Canada's licence-exempt RSS(s). Operation is subject to the following two conditions:

- (1) This device may not cause interference.
- (2) This device must accept any interference, including interference that may cause undesired operation of the device

L'émetteur/récepteur exempt de licence contenu dans le présent appareil est conforme aux CNR d'Innovation, Sciences et Développement économique Canada applicables aux appareils radio exempts de licence. L'exploitation est autorisée aux deux conditions suivantes :

- 1.L'appareil ne doit pas produire de brouillage;
- 2.L'appareil doit accepter tout brouillage radioélectrique subi, même si le brouillage est susceptible d'en compromettre le fonctionnement.

For projectors only

The distance between user and products should be no less than 20cm.

La distance entre l'utilisateur et le produit ne doit pas être inférieure à 20 cm.

5150-5350MHz band is restricted to indoor use only.

La bande de 5150-5350MHz est réservée à l'usage intérieur.



WARNING: This product can expose you to Lead, which is known to the State of California to cause cancer and birth defects or other reproductive harm. For more information go to www.P65Warnings.ca.gov

Langue

English	01-19
Deutsch	20-39
Français	40-59
Italiano	60-79
Español	80-99
日本語	100-119

Contenu

Lire avant toute utilisation	41
Liste de colisage	42
Présentation du projecteur	43
Présentation de la télécommande	45
Comment démarrer	46
Paramètres réseau	49
Paramètres de mise au point	49
Paramètres de correction de l'image	50
Mode haut-parleur Bluetooth	51
Assistant Google	51
Chromecast built-in & miroir d'écran	52
Entrées	53
Autres paramètres	53
Spécifications	54
Dépannage	54
Précautions importantes	57
Déclaration	58

Lire avant toute utilisation

Veillez lire attentivement les instructions relatives au produit:

Nous vous remercions d'avoir acheté et d'utiliser nos produits.

Pour votre sécurité et dans votre intérêt, veuillez lire attentivement les instructions du produit avant de l'utiliser.

A propos des instructions du produit:

Les marques et les noms mentionnés dans les instructions du produit sont la propriété de leurs détenteurs respectifs.

Toutes les instructions du produit sont présentées uniquement à des fins d'illustration. Le produit réel peut varier en raison des améliorations apportées au produit.

Nous ne serons pas tenus responsables de toute blessure corporelle, de tout dommage matériel ou de tout autre dommage causé par le non-respect des instructions ou des précautions du produit par l'utilisateur.

* Dangbei se réserve le droit d'interpréter et de modifier les instructions du produit.

Liste d'emballage

Avant d'utiliser le produit, veuillez vérifier que tous les éléments se trouvent bien dans la boîte.

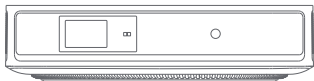

Projecteur



Télécommande
(piles non incluses)



Adaptateur d'alimentation



Câble d'alimentation

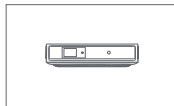

Manuel d'utilisation

Présentation du projecteur

Présentation et description de l'interface.

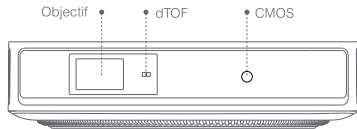

Vue de face

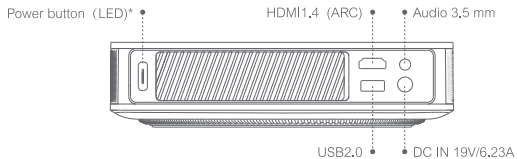

Vue arrière

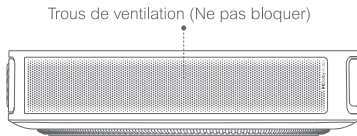

Left View

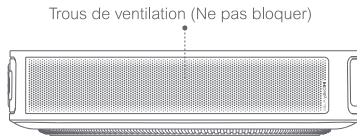

Vue de droite



Vue de dessus

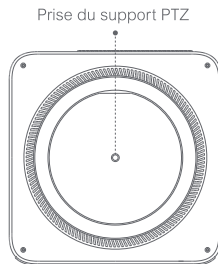

Vue du bas

Guide de l'indicateur LED du bouton d'alimentation

Bouton	État de la LED	Description
 Bouton d'alimentation	Allumé	Mode veille / Mise sous tension / Appairage réussi en mode enceinte Bluetooth / Éteindre
	Éteint	En projection
	Clignotement	Mise à jour du firmware / Appairage en cours en mode enceinte Bluetooth

Présentation de la télécommande

- Ouvrir le couvercle du compartiment à piles de la télécommande.
- Installer 2 piles du type AAA (**non fournies**) *.
- Remettre en place le couvercle du compartiment à piles.

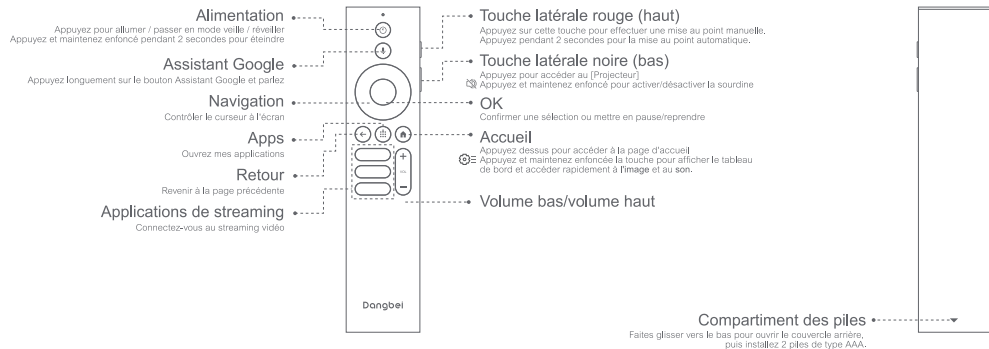

* Veuillez mettre en place des piles neuves en respectant les indications de polarité.

Comment démarrer

1.Emplacement

Placez le projecteur sur une surface stable et plate, devant la surface de projection. Une surface de projection lisse et blanche est recommandée. Veuillez suivre les instructions ci-dessous pour déterminer la distance entre le projecteur et la surface de projection, ainsi que la taille de projection correspondante :

Taille	Écran (Longueur x Largeur)
60 pouces	133 x 75 cm 4.36x2.46 ft
80 pouces	177 x 100 cm 5.8x 3.28 ft
100 pouces	221 x 124 cm 7.25 x 4.06 ft
120 pouces	265 x 149 cm 8.69 x 4.88 ft



La meilleure taille de projection recommandée est de 100 pouces.

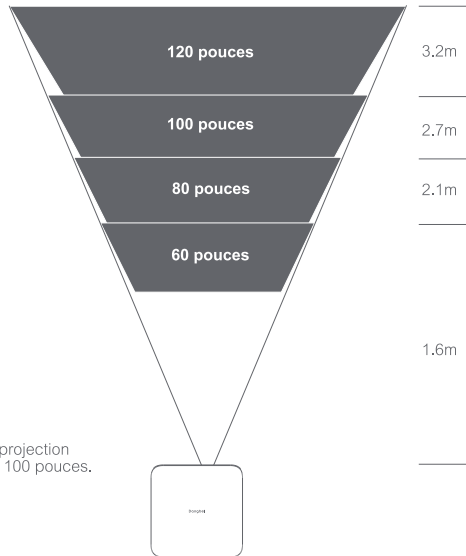

2. Mise sous tension

- ① Connectez le projecteur à la prise de courant.

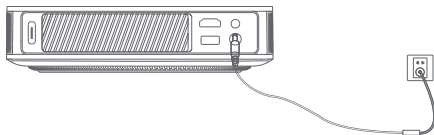

- ② Appuyez sur le bouton d'alimentation sur le projecteur ou la télécommande pour allumer le projecteur.

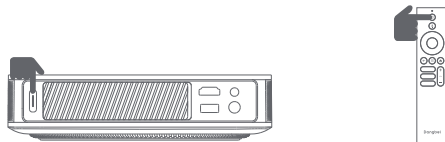

3. Mode veille / Éteindre

Appuyez sur le bouton d'alimentation sur le projecteur ou la télécommande pour entrer en mode veille. Maintenez enfoncé le bouton d'alimentation sur le projecteur ou la télécommande pendant 2 secondes pour éteindre le projecteur.

3. Jumelage de la télécommande

- Allumez le projecteur et attendez que l'invite d'appairage Bluetooth s'affiche à l'écran.
- Approchez la télécommande à moins de 10 cm du projecteur.
- Appuyez simultanément sur les touches  et  et maintenez-les enfoncées.
- Relâchez les touches lorsque le voyant commence à clignoter.
- Attendez jusqu'à ce que vous entendiez deux "bips", ce qui indique que l'appairage a réussi.

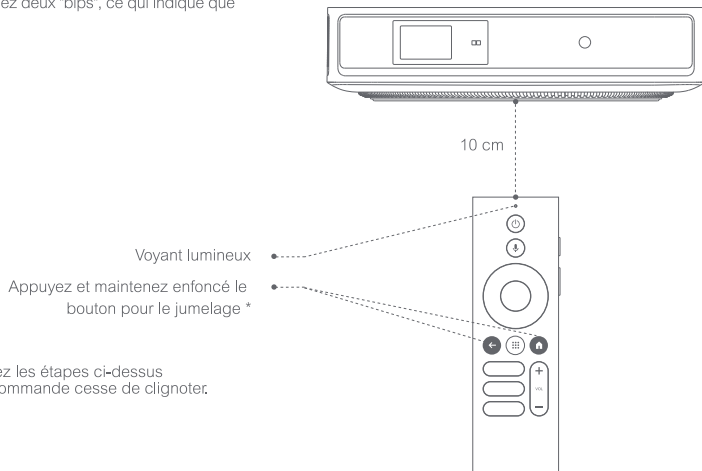

* Si le jumelage ne réussit pas, répétez les étapes ci-dessus jusqu'à ce que le voyant de la télécommande cesse de clignoter.

Paramètres du réseau

- Allez dans [Paramètres], sélectionnez [Réseau et Internet] et activez le Wi-Fi.
- Choisissez votre réseau et entrez le bon mot de passe.

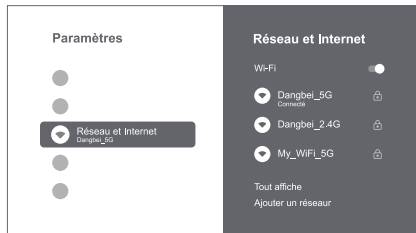

Paramètres de mise au point

Méthode 1: Appuyez sur la touche latérale rouge (haut) pour la mise au point manuelle. Appuyez sur cette touche pendant 2 secondes pour la mise au point automatique.

Méthode 2: Allez dans [projecteur], sélectionnez [Mise au point] et choisissez entre la mise au point manuelle et la mise au point automatique.

Allez dans [Réglages du projecteur], sélectionnez [Réglages de la mise au point] et choisissez entre la mise au point manuelle et la mise au point automatique.

Mise au point automatique

Sélectionnez [Autofocus (Mise au point automatique)] pour déclencher la fonction autofocus. L'image devient alors nette automatiquement.

Mise au point manuelle

Sélectionnez [Mise au point manuelle] et utilisez les touches de navigation (haut/bas) de la télécommande pour régler la distance de mise au point et obtenir une image claire.



Paramètres de correction de l'image

1. Correction de la distorsion trapézoïdale

- Allez dans [Projecteur] – [Correction de l'image].
- Sélectionnez [Correction automatique de la distorsion trapézoïdale], et l'écran sera automatiquement corrigé.
- Sélectionnez [Correction manuelle de la distorsion trapézoïdale], et utilisez les touches de navigation pour ajuster les quatre points et la forme de l'image.

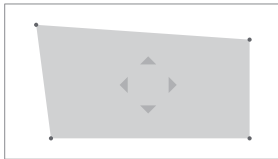

2. Ajustement intelligent de l'image sur l'écran

- Allez dans [Projecteur] – [Correction de l'image] et activez [Ajuster à l'écran].
- Suivez les instructions à l'écran pour ajuster automatiquement l'image en fonction de l'écran.

3. Évitement intelligent des obstacles

- Allez dans [Projecteur] – [Correction de l'image] – [Avancé], et activez [Évitement des obstacles].
- Suivez les instructions à l'écran pour régler automatiquement l'image projetée afin d'éviter tout objet se trouvant sur la surface de projection.

Mode haut-parleur Bluetooth

- Go to [SeAller dans [Paramètres], sélectionnez [Projecteur] et cliquez sur [Mode haut-parleur Bluetooth].
- Connectez votre téléphone à un appareil dont le nom Bluetooth contient "DBOD02".Après avoir modifié le nom de l'appareil, le nom Bluetooth sera lui aussi synchronisé en conséquence.
- Lorsque vous entendez " Connexion Bluetooth réussie ", le projecteur peut alors lire de la musique à partir de votre téléphone.
- Appuyez sur la touche  de la télécommande pendant 2 secondes pour quitter le [Mode haut-parleur Bluetooth].

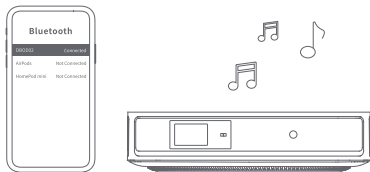

Assistant Google

Votre téléviseur est plus utile que jamais. Utilisez votre voix pour trouver des films, diffuser des applications, écouter de la musique et contrôler la télévision. Demandez à Assistant Google de trouver un titre spécifique, de rechercher par genre ou d'obtenir des recommandations personnalisées. Obtenez même des réponses à l'écran, contrôlez des appareils connectés de la maison, et bien plus. Appuyez sur le bouton Assistant Google de la télécommande pour commencer.

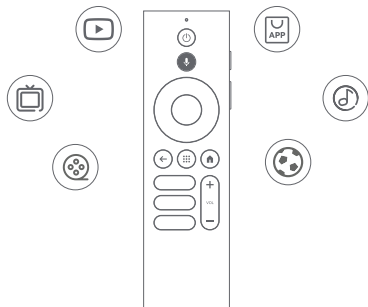

Chromecast built-in & miroir d'écran

Vous pouvez diffuser sans fil des films, des jeux, de la musique et l'écran de votre appareil iOS, macOS, Android™ ou Windows vers le projecteur.

*Assurez-vous que le projecteur et votre appareil sont connectés au même réseau sans fil.

1.Chromecast built-in

Pour diffuser du contenu depuis une application :

Vous pouvez diffuser du contenu à partir d'applications compatibles Chromecast telles que YouTube et d'autres applications de streaming.

1. Connectez votre appareil et le projecteur au même réseau sans fil.
2. Ouvrez l'application de streaming sur votre appareil.
3. Lancez une vidéo et appuyez sur l'icône de diffusion  à l'écran de la vidéo.
4. Sélectionnez "DBOD02" pour vous connecter. Le projecteur affichera la vidéo depuis votre appareil.

*En raison de restrictions de droits d'auteur, certains contenus ne peuvent pas être diffusés sur le projecteur. Vous pouvez diffuser le contenu sur le projecteur en installant la même application dessus.

2.Screen Mirroring via AirScreen

Pour diffuser l'écran de l'appareil :

Vous pouvez projeter l'intégralité de l'écran de votre appareil sur le projecteur.

1. Assurez-vous que votre appareil et le projecteur sont connectés au même réseau sans fil.
2. Installez l'application AirScreen sur le projecteur.
3. Ouvrez l'application AirScreen et suivez les instructions à l'écran pour terminer le processus.

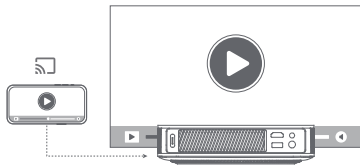

Entrées

- Allez dans [Contributions] – HDMI/HOME/USB.
- Consultez le contenu provenant de différentes sources de signaux.

*L'interface HDMI de ce produit est HDMI 1.4 et elle n'est pas compatible avec l'entrée d'un signal vidéo 4K.

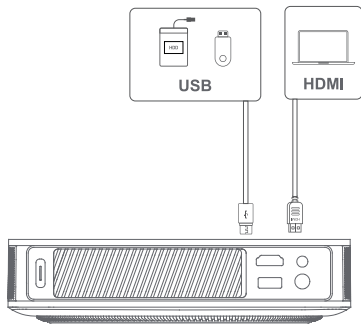

Autres Paramétrages

1.Température de couleur

Allez dans [Paramètres] – [Affichage et son] -- [Image] -- [Température de couleur] pour sélectionner [Standard/Chaude/Soins des yeux].

2.Mode de projection

Allez dans [Paramètres] – [Projecteur] -- [Paramètres avancés] – [Mode de projection] pour choisir la méthode de placement du projecteur.

3.Zoom

Allez dans [Paramètres] – [Projecteur] – [Correction d'image] – [Adaptation de l'image] – [Zoom] pour réduire la taille de l'image de 100 % à 50 %.

4.Mode 3D

Avant d'activer le mode 3D, allez dans [Paramètres] -- [Projecteur] -- [Correction d'image], et cliquez sur [Réinitialisation de l'image par défaut] pour restaurer l'image à son état par défaut.

Allez dans [Paramètres] – [Image] – [Mode 3D] pour activer le mode 3D.

*Il est recommandé de désactiver la fonction [Correction automatique de la distorsion trapézoïdale après un mouvement] lors de l'activation du mode 3D afin d'éviter toute modification de l'image par rapport à son état par défaut après avoir déplacé le projecteur, ce qui pourrait empêcher alors l'utilisation du mode 3D.

5.Informations sur le système et le produit

Allez dans [Paramètres] -- [Système] -- [À propos] pour vérifier les informations sur le système et le produit.

Spécifications

Technologie d'affichage	0.33 pouces, DLP	Version Bluetooth	5.1
Résolution de l'écran	1920 x 1080	WI-FI	Double fréquence 2.4/5.0 GHz
Rapport de projection	1.2:1	Dimensions (LxlxH)	195 × 195 × 47.5 mm 7.68 x 7.68 x 1.87 pouces
Haut-parleurs	2 x 5 W	Poids	1.28kg /2.82lb

Fehlersuche

1. Aucune sortie audio

- a. Vérifiez si vous avez appuyé deux fois sur la touche noire située sur le côté de la télécommande, cela pourrait avoir mis le projecteur en mode silencieux.
- b. Vérifiez si l'interface du projecteur "HDMI ARC" ou Bluetooth est connectée à un appareil audio externe.

2. Aucune sortie d'image

- a. Appuyez sur le bouton d'alimentation situé à l'arrière du projecteur. Le témoin lumineux du bouton d'alimentation s'éteindra si le projecteur passe en mode de projection avec succès.
- b. Assurez-vous que l'adaptateur d'alimentation a une sortie d'alimentation.

3. Pas de réseau

- a. Entrez dans les paramètres, et vérifiez l'état de la connexion réseau dans l'option réseau.
- b. Assurez-vous que le câble réseau est correctement inséré dans l'interface "LAN" du projecteur.
- c. Assurez-vous que le routeur est correctement configuré.

4. Image floue

- a. Réglez la mise au point ou la distorsion trapézoïdale.
- b. Le projecteur et l'écran/le mur doivent être placés en respectant une certaine distance effective.
- c. L'objectif du projecteur n'est pas propre.

5. Image non rectangulaire

- a. Placez le projecteur perpendiculairement à l'écran/au mur si la fonction de correction de la distorsion trapézoïdale n'est pas utilisée.
- b. Utilisez la fonction de correction trapézoïdale pour régler l'affichage.

6. Échec de la correction automatique du trapèze

- a. Assurez-vous que la caméra/TOF du panneau avant n'est pas bloquée ou sale.
- b. La meilleure distance de correction automatique du trapèze est de 2,0-4,0m, horizontale $\pm 30^\circ$.

7. Échec de la mise au point automatique

- a. Assurez-vous que la caméra/TOF sur le panneau avant n'est pas bloquée ou sale.
- b. La meilleure distance autofocus est de 2,0-4,0m, horizontale $\pm 20^\circ$.

8. Échec de la protection intelligente des yeux

- a. Assurez-vous que la caméra/TOF sur la façade avant n'est pas bloquée ou sale.
- b. La plage de détection optimale se situe autour du centre de l'image. Si vous êtes trop près des bords, la protection oculaire risque de ne pas se déclencher.
- c. Assurez-vous que le motif de la boîte rouge se trouve dans le cadre de l'écran et qu'il n'est pas bloqué.

9. Échec de l'ajustement de l'écran intelligent

- a. Assurez-vous que le projecteur est correctement positionné, de manière à ce que l'image projetée dépasse les bords de l'écran.
- b. Assurez-vous que l'écran de projection a une bordure/cadre de couleur sur les quatre côtés, afin que le projecteur puisse reconnaître le cadre.
- c. Assurez-vous que le motif de la boîte rouge se trouve dans le cadre de l'écran et qu'il n'est pas bloqué.

10. La télécommande ne réagit pas

- a. Assurez-vous que la télécommande a été correctement appariée via Bluetooth. Si l'appairage est réussi, le voyant LED clignotera une fois en appuyant sur n'importe quel bouton. Lorsque vous appuyez sur un bouton et que vous le maintenez enfoncé, le voyant LED reste toujours allumé.
- b. Si l'appairage a échoué, le voyant LED clignotera trois fois en appuyant sur n'importe quel bouton. Lorsque vous appuyez sur un bouton et que vous le maintenez enfoncé, le voyant LED clignote trois fois, puis reste allumé en continu.
- c. Vérifiez si le témoin lumineux d'alimentation reste allumé sans appuyer sur aucun bouton. Si c'est le cas, vérifiez si des boutons de la télécommande sont coincés.
- d. Assurez-vous qu'il n'y a pas d'interférences ou d'obstructions entre le projecteur et la télécommande.
- e. Vérifiez la polarité de la pile et de l'installation.

11. Connexion des périphériques Bluetooth

Entrez dans les paramètres, ouvrez l'option Bluetooth pour vérifier la liste des périphériques Bluetooth, et connectez le périphérique.

12. Autres

N'hésitez pas à nous contacter à l'adresse support.eu@dangbei.com.

Précautions importantes

- Do not look directly at the projection beam with your eyes, because the strong beam may harm your eyes. RG2 IEC 60825-1:2014
- Do not block or cover the heat dissipation holes of the device to avoid affecting the heat dissipation of the internal parts, and damaging the device.
- Keep away from humidity, exposure, high temperature, low pressure, and magnetic environments.
- Do not place the device in areas susceptible to excessive dust and dirt.
- Place the device in a flat and stable station, and do not place the device on a surface that is prone to vibration.
- Do not allow children to handle the device without supervision.
- Do not place heavy or sharp objects on the device.
- Avoid extreme vibrations, because these may damage the internal components.
- Please use the correct type of battery for the remote control.
- Only use attachments/accessories specified or provided by the manufacturer (such as the exclusive power adapter, bracket, etc.).
- Do not disassemble the device. The device should only be repaired by staff authorized by the manufacturer.
- Place and use the device in a 5-35°C environment.
- Le boîtier en métal est revêtu de peinture isolante.
- The plug is considered as a disconnected device of the adapter.
- The adapter should be installed near the equipment, and should be easily accessible.
- Protect the power cord from being walked on or pinched, particularly at the plugs, convenience receptacles, and the point where this exits from the device.
- Unplug this device if there are lightning storms or when unused for a long period of time.
- Where the power plug or an appliance coupler is used to disconnect the device, the disconnected device would remain readily operable.
- Never touch the power cable or power connector with wet hands.
- Risk of explosion if battery is replaced by an incorrect type. Dispose of used batteries according to local regulations.



Déclaration

Google TV is the name of this device's software experience and a trademark of Google LLC.
Google, YouTube and Chromecast built-in are trademarks of Google LLC.

This equipment has been tested and found to comply with the limits for a Class B digital device, pursuant to Part 15 of the FCC Rules. These limits are designed to provide reasonable protection against harmful interference in a residential installation.

This equipment generates uses and can radiate radio frequency energy and, if not installed and used in accordance with the instructions, may cause harmful interference to radio communications. However, there is no guarantee that interference will not occur in a particular installation. If this equipment does cause harmful interference to radio or television reception, which can be determined by turning the equipment off and on, the user is encouraged to try to correct the interference by one or more of the following measures:

- Reorient or relocate the receiving antenna.
- Increase the separation between the equipment and receiver.
- Connect the equipment to an outlet on a circuit different from that to which the receiver is connected.
- Consult the dealer or an experienced radio/TV technician for help.

Changes or modifications not expressly approved by the party responsible for compliance could void the user's authority to operate the equipment.

We declare that this device is in compliance with the essential requirements and other relevant provisions of Directive 2014/53/EU. Satisfies all the technical regulations applicable to the product within the scope of UK Radio Equipment Regulations (SI 2017/1206); UK Electrical Equipment (Safety) Regulations (SI 2016/1101); and UK Electromagnetic Compatibility Regulations (SI 2016/1091). This device operating frequency: 2402-2480MHz (EIRP < 20dBm), 2412-2472MHz (EIRP < 20dBm), 5150~5250MHz (EIRP < 23dBm), 5250~5350MHz (EIRP < 20dBm), 5470~5725MHz (EIRP < 27dBm), 5725~5850MHz (EIRP < 13.98dBm).

 We declares that this device is in compliance with the essential requirements and other relevant provisions of Directive 2014/53/EU.

 Satisfies all the technical regulations applicable to the product within the scope of UK Radio Equipment Regulations (SI 2017/1206); UK Electrical Equipment (Safety) Regulations (SI 2016/1101); and UK Electromagnetic Compatibility Regulations (SI 2016/1091).



Manufactured under license from Dolby Laboratories. Dolby, Dolby Audio, and the double-D symbol are trademarks of Dolby Laboratories Licensing Corporation.

NETFLIX

Netflix is a trademark of Netflix, Inc.

THIS DEVICE COMPLIES WITH DHHS RULES 21 CFR CHAPTER I SUBCHAPTER J.
CAN ICES-3 (B)/NMB-3 (B)

This Class B digital apparatus complies with Canadian ICES-003.

Cet appareil numérique de classe B est conforme à la norme canadienne ICES-003.

This device contains licence-exempt transmitter(s)/receiver(s) that comply with Innovation, Science and Economic Development Canada's licence-exempt RSS(s). Operation is subject to the following two conditions:

- (1) This device may not cause interference.
- (2) This device must accept any interference, including interference that may cause, undesired operation of the device

L'émetteur/récepteur exempt de licence contenu dans le présent appareil est conforme aux CNR d'Innovation, Sciences et Développement économique Canada applicables aux appareils radio exempts de licence. L'exploitation est autorisée aux deux conditions suivantes :

- 1.L'appareil ne doit pas produire de brouillage;
- 2.L'appareil doit accepter tout brouillage radioélectrique subi, même si le brouillage est susceptible d'en compromettre le fonctionnement.

For projectors only

The distance between user and products should be no less than 20cm.

La distance entre l'utilisateur et le produit ne doit pas être inférieure à 20 cm.

5150-5350MHz band is restricted to indoor use only.

La bande de 5150-5350MHz est réservée à l'usage intérieur.



WARNING: This product can expose you to Lead, which is known to the State of California to cause cancer and birth defects or other reproductive harm. For more information go to www.P65Warnings.ca.gov

Lingua

English	01-19
Deutsch	20-39
Français	40-59
Italiano	60-79
Español	80-99
日本語	100-119

Contenuti

Leggere prima dell'uso	61
Elenco degli imballaggi	62
Panoramica del proiettore	63
Panoramica del telecomando	65
Guida introduttiva	66
Impostazioni di rete	69
Impostazioni di messa a fuoco	69
Impostazioni di correzione dell'immagine	70
Modalità altoparlante Bluetooth	71
Assistente Google	71
Chromecast built in e Screen Mirroring	72
Ingressi	73
Altre impostazioni	73
Specifiche tecniche	74
Risoluzione dei problemi	74
Avvertenze importanti	77
Nota	78

Leggere prima dell'uso

Le preghiamo di leggere attentamente le istruzioni del prodotto:

Grazie per aver acquistato e utilizzato questi prodotti.

Per la tua sicurezza e il tuo interesse, ti invitiamo a leggere attentamente le istruzioni del prodotto prima di utilizzarlo.

Informazioni sulle istruzioni del prodotto:

I marchi e i nomi citati nelle Istruzioni per l'uso sono di proprietà dei rispettivi titolari.

Tutte le Istruzioni per l'uso del prodotto riportate sono solo a scopo illustrativo. Il prodotto reale può variare a causa di miglioramenti del prodotto.

Dangbei non sarà responsabile per eventuali lesioni personali, danni alla proprietà o altri danni causati dalla mancata osservanza delle istruzioni o precauzioni da parte dell'utente.

* Dangbei si riserva il diritto di interpretare e modificare le Istruzioni del Prodotto.

Elenco degli imballaggi

Prima di utilizzare il prodotto, controlla che tutti gli articoli siano inclusi nella confezione.

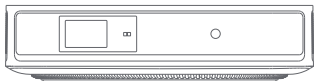

Proiettore



Telecomando
(batterie non incluse)



Adattatore di potenza



Cavo di alimentazione

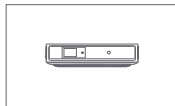

Manuale d'uso

Panoramica del proiettore

Panoramica e descrizione dell'interfaccia.

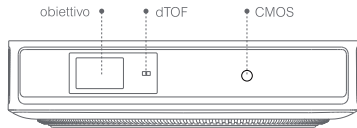

Veduta frontale

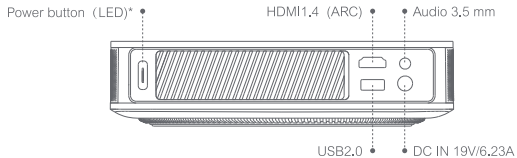

Veduta posteriore

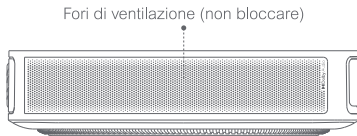

Left View

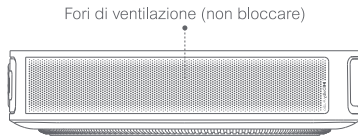

Veduta destra



Veduta dall'alto

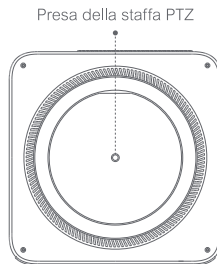

Veduta inferiore

Pulsante di accensione guida agli indicatori LED

Pulsante	Stato del LED	Descrizione
 Pulsante di accensione	Acceso	Modalità standby / Accensione / Connessione altoparlante Bluetooth riuscita / Spegnimento
	Spento	In proiezione
	Lampeggio	Aggiornamento del firmware / Connessione altoparlante Bluetooth in corso

Panoramica del telecomando

- Apri il coperchio del vano batterie del telecomando.
- Installa 2 batterie AAA (**non incluse**)*.
- Riposiziona il coperchio del vano batterie.

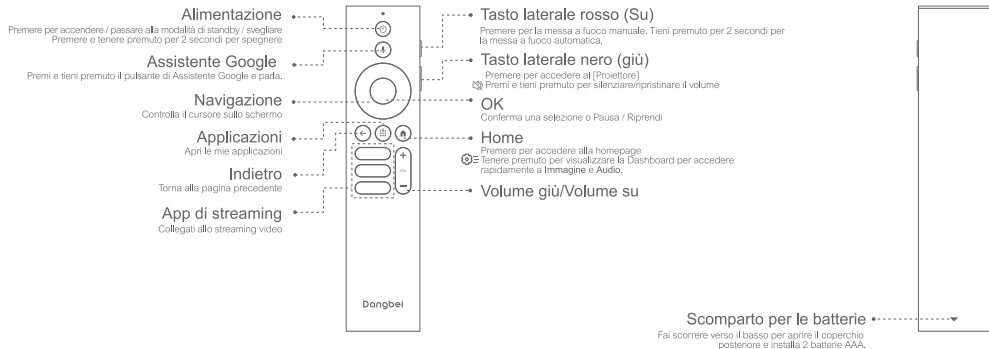

* Inserire le batterie nuove rispettando le indicazioni di polarità.

Guida introduttiva

1.Posizionamento

Posiziona il proiettore su una superficie stabile e piana di fronte alla superficie di proiezione. Si consiglia una superficie di proiezione piatta e bianca.

Segui le istruzioni riportate di seguito per determinare la distanza tra il proiettore e la superficie di proiezione e il formato di proiezione corrispondente:

Dimensioni	Schermo (Lunghezza x Larghezza)
60 pollici	133 x 75 cm 4.36x2.46 ft
80 pollici	177 x 100 cm 5.8x 3.28 ft
100 pollici	221 x 124 cm 7.25 x 4.06 ft
120 pollici	265 x 149 cm 8.69 x 4.88 ft



La dimensione di proiezione migliore consigliata è di 100 pollici.

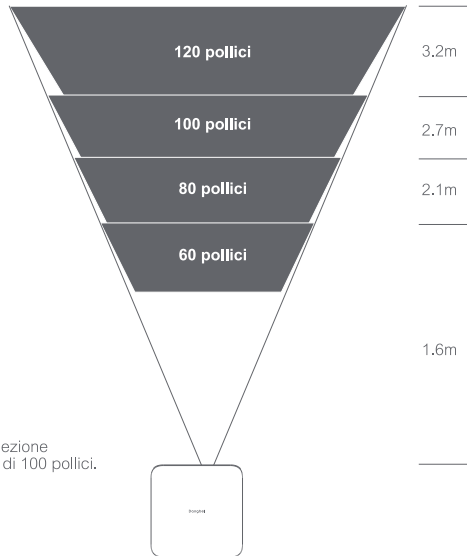

2. Accensione

- ① Collega il proiettore alla presa di corrente.

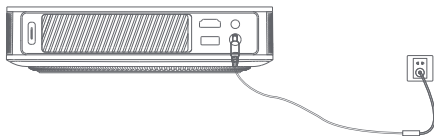

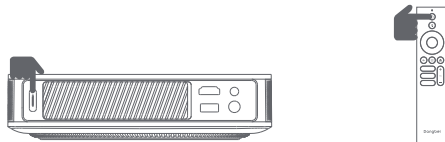

- ② Premere il pulsante di accensione sul proiettore o sul telecomando per accendere il proiettore.



3. Modalità standby / Spegnimento

Premere il pulsante di accensione sul proiettore o sul telecomando per entrare in modalità standby.
Premere e tenere premuto il pulsante di accensione sul proiettore o sul telecomando per 2 secondi per spegnere il proiettore.

3. Abbinamento del telecomando

- Accendi il proiettore e attendi la richiesta di accoppiamento Bluetooth sullo schermo.
- Porta il telecomando a 10 cm dal proiettore.
- Tieni premuti contemporaneamente i tasti  e .
- Rilascia i tasti dopo che l'indicatore luminoso inizia a lampeggiare.
- Attendi fino a quando non sentirai due "bip" che indicano che l'abbinamento è andato a buon fine.

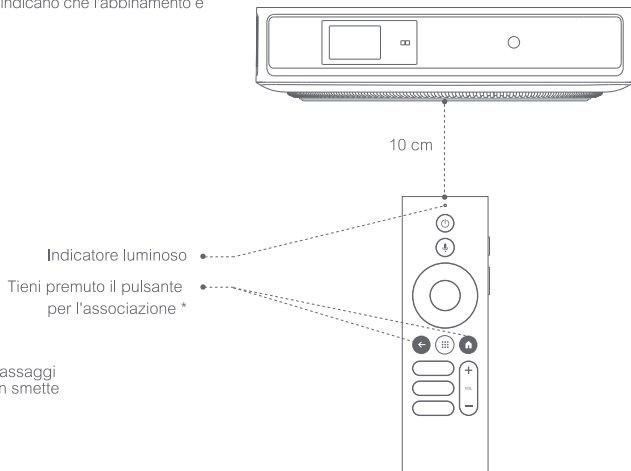

* Se l'abbinamento non va a buon fine, ripeti i passaggi precedenti finché la spia del telecomando non smette di lampeggiare.

Impostazioni di rete

- Vai su [Impostazioni], seleziona [Rete e Internet] e attiva il Wi-Fi.
- Scegli la tua rete e inserisci la password corretta.



Impostazioni di messa a fuoco

Metodo 1: Premi il tasto laterale rosso (su) per la messa a fuoco manuale. Tieni premuto per 2 secondi per la messa a fuoco automatica.

Metodo 2: Vai in [Proiettore], seleziona [messa a fuoco] e scegli la messa a fuoco manuale o la messa a fuoco automatica.

Messa a fuoco automatica

Seleziona [Messa a fuoco automatica] per attivare la funzione di autofocus. L'immagine diventerà automaticamente chiara.

Messa a fuoco manuale

Seleziona [Messa a fuoco manuale] e usa i tasti di navigazione (su / giù) del telecomando per regolare la distanza di messa a fuoco e rendere l'immagine nitida.



Impostazioni di correzione dell'immagine

1. Correzione Keystone

- Vai a [Impostazioni del proiettore] – [Correzione dell'immagine].
- Seleziona [Correzione trapezoidale automatica], e lo schermo verrà automaticamente corretto.
- Seleziona [Correzione trapezoidale manuale], e usa i tasti di navigazione per regolare i quattro punti e la forma dell'immagine.

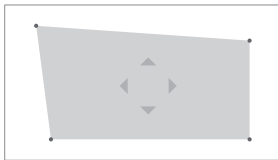

2. Adattamento intelligente dello schermo

- Vai in [Impostazioni del proiettore] – [Correzione dell'immagine] e attiva [Adattamento allo schermo].
- Segui le istruzioni sullo schermo per regolare automaticamente l'immagine proiettata per adattarla allo schermo.

3. Evitamento intelligente degli ostacoli

- Vai in [Impostazioni del proiettore] – [Correzione dell'immagine] -- [Avanzate] e attiva [Evita ostacoli].
- Segui le istruzioni sullo schermo per regolare automaticamente l'immagine proiettata in modo da evitare gli oggetti presenti sulla superficie di proiezione.

Modalità altoparlante Bluetooth

- Vai in [Impostazioni], seleziona [Proiettore] e clicca su [Modalità altoparlante Bluetooth].
- Collega il telefono a un dispositivo con nome Bluetooth contenente "DBOD02". Dopo aver modificato il nome del dispositivo, anche il nome Bluetooth verrà sincronizzato di conseguenza.
- Quando sentirai "connessione Bluetooth riuscita", il proiettore potrà riprodurre la musica dal tuo telefono.
- Tieni premuto il tasto  del telecomando per 2 secondi per uscire dalla [Modalità altoparlante Bluetooth].

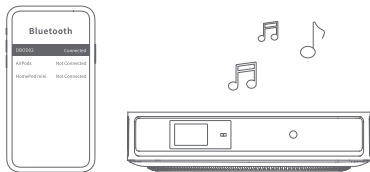

Assistente Google

Il tuo televisore è più utile che mai. Usa la tua voce per trovare film, accedere a servizi di streaming, riprodurre musica e controllare la TV. Chiedi a Assistente Google di cercare un titolo specifico, cercare per genere o ricevere raccomandazioni personalizzate. Puoi persino ottenere risposte sullo schermo, controllare dispositivi smart home e altro ancora. Premi il pulsante Assistente Google sul telecomando per iniziare.



Chromecast built-in e Screen Mirroring

Puoi proiettare senza fili film, giochi, musica e lo schermo del tuo dispositivo iOS, macOS, Android™ o Windows sul proiettore.
*Assicurati che il proiettore e il tuo dispositivo siano connessi alla stessa rete wireless.

1.Chromecast built-in

Per trasmettere contenuti dall'app:

È possibile trasmettere contenuti da app abilitate per Chromecast come YouTube e altre app di streaming.

1. Connetti il tuo dispositivo e il proiettore alla stessa rete wireless.
2. Apri l'app di streaming sul tuo dispositivo.
3. Riproduci un video e tocca l'icona di trasmissione  sullo schermo del video.
4. Seleziona "DBOD02" per connetterti. Il proiettore visualizzerà il video dal tuo dispositivo.

*A causa di restrizioni legate al copyright, alcuni contenuti non possono essere trasmessi al proiettore.
Puoi trasmettere il contenuto sul proiettore installando la stessa applicazione su di esso.

2. Mirroring dello schermo tramite AirScreen

Per trasmettere lo schermo del dispositivo:

Puoi proiettare l'intero schermo del tuo dispositivo sul proiettore.

1. Assicurati che sia il tuo dispositivo che il proiettore siano connessi alla stessa rete wireless.
2. Installa l'app AirScreen sul proiettore.
3. Apri l'app AirScreen e segui le istruzioni visualizzate per completare il processo.

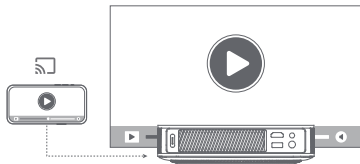

Ingressi

- Vai su [Ingressi] -- HDMI/HOME/USB.
 - Guarda i contenuti da diverse fonti di segnale.
- *L'interfaccia HDMI di questo prodotto è HDMI 1.4 e non supporta l'ingresso di segnali video 4K.

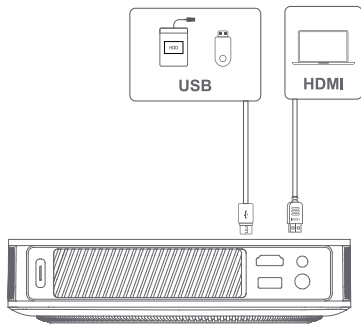

Altre impostazioni

1.Temperatura del colore

Vai a [Impostazioni] – [Display e audio] -- [Immagine] – [Temperatura colore] per selezionare [Standard/Caldo/Curadegli occhi].

2.Modalità di proiezione

Vai in [Impostazioni] -- [Proiettore] -- [Impostazioni avanzate] – [Modalità di proiezione] per scegliere il metodo di posizionamento del proiettore.

3.Zoom

Vai a [Impostazioni] – [Proiettore] – [Correzione dell'immagine] – [Adattamento immagine] – [Zoom] per ridurre le dimensioni dell'immagine dal 100% al 50%.

4.Modalità 3D

Prima di attivare la modalità 3D, andare su [Impostazioni] – [Proiettore] -- [Correzione dell'immagine] e fare clic su [Ripristino dell'immagine predefinita] per ripristinare l'immagine allo stato predefinito. Accedere a [Impostazioni] – [Immagine] – [Modalità 3D] per abilitare la modalità 3D. *Si consiglia di disabilitare la funzione [Correzione automatica della distorsione trapezoidale dopo il movimento] quando si abilita la modalità 3D per evitare di alterare l'immagine dallo stato predefinito dopo aver spostato il proiettore, il che potrebbe impedire l'uso della modalità 3D.

5.Informazioni sul sistema e sul prodotto

Vai su [Impostazioni] – [Sistema] – [Informazioni] per controllare le informazioni sul sistema e sul prodotto.

Specifiche tecniche

Tecnologia dello schermo	0.33 pouces, DLP	Versione Bluetooth	5.1
Risoluzione dello schermo	1920 x 1080	WI-FI	a doppia frequenza 2.4/5.0 GHz
Rapporto di proiezione	1.2:1	Dimensioni (LxLxH)	195 × 195 × 47.5 mm 7.68 x 7.68 x 1.87 pouces
Altoparlanti	2 x 5 W	Peso	1.28kg /2.82lb

Risoluzione dei problemi

1. Nessuna uscita audio

- a. Verifica se hai premuto due volte il tasto nero sul lato del telecomando, potresti aver messo il proiettore in modalità silenziosa.
- b. Controlla se l'interfaccia del proiettore "HDMI ARC" o il Bluetooth sono collegati a un dispositivo audio esterno.

2. Nessuna immagine in uscita

- a. Premere il pulsante di accensione situato sul retro del proiettore. La spia del pulsante di accensione si spegnerà se il proiettore entra correttamente in modalità di proiezione.
- b. Assicurati che l'adattatore di alimentazione abbia un'uscita di corrente.

3. Nessuna rete

- a. Entra nelle impostazioni e controlla lo stato della connessione di rete nell'opzione Rete.
- b. Assicurati che il cavo di rete sia inserito correttamente nell'interfaccia del proiettore "LAN".
- c. Assicurati che il router sia configurato correttamente.

4. Immagine sfocata

- a. Regola la messa a fuoco o il keystone.
- b. Il proiettore e lo schermo/muro devono essere posizionati a una distanza efficace.
- c. La lente del proiettore non è pulita.

5. Immagine non rettangolare

- a. Posiziona il proiettore perpendicolare allo schermo/muro se non si utilizza la funzione di correzione Keystone.
- b. Usa la funzione Keystone per regolare la visualizzazione.

6. Correzione keystone automatica fallita

- a. Assicurati che la telecamera/TOF sul pannello frontale non sia bloccata o sporca.
- b. La distanza migliore per la correzione keystone automatica è 2,0-4,0m, orizzontale $\pm 30^\circ$.

7. Mancata messa a fuoco automatica

- a. Assicurati che la telecamera/TOF sul pannello frontale non sia bloccata o sporca.
- b. La distanza migliore per l'autofocus è di 2,0-4,0m, in orizzontale $\pm 20^\circ$.

8. Protezione intelligente degli occhi non riuscita

- a. Protezione intelligente degli occhi non riuscita
- b. Il campo di rilevamento ottimale si trova intorno al centro dell'immagine. Se si è troppo vicini ai bordi, la funzione di protezione degli occhi potrebbe non attivarsi.

9. Errore di adattamento dello schermo intelligente

- a. Assicurati che il proiettore sia posizionato correttamente, in modo che l'immagine proiettata si estenda oltre i bordi dello schermo.
- b. Assicurati che lo schermo di proiezione abbia un bordo/quadro colorato su tutti e quattro i lati, in modo che il proiettore possa riconoscere la cornice.
- c. Assicurati che il motivo del riquadro rosso sia all'interno della cornice dello schermo e non sia bloccato.

10. Il telecomando non risponde

- a. Assicurati che il telecomando sia accoppiato correttamente via Bluetooth. Se l'accoppiamento è riuscito, il LED lampeggia una volta quando premi un pulsante qualsiasi. Se tieni premuto un pulsante qualsiasi, la luce del LED rimarrà fissa.
- b. Se l'accoppiamento non è riuscito, la luce del LED lampeggerà tre volte quando premi un pulsante qualsiasi. Quando tieni premuto un pulsante qualsiasi, la luce del LED lampeggia tre volte e poi rimane fissa.
- c. Verifica se l'indicatore di alimentazione rimane acceso senza premere alcun pulsante. In caso affermativo, controlla se i pulsanti del telecomando sono bloccati.
- d. Assicurati che non ci siano interferenze o ostruzioni tra il proiettore e il telecomando.
- e. Controlla la polarità della batteria e dell'installazione.

11. Collegare i dispositivi Bluetooth

Entra nelle impostazioni, apri l'opzione Bluetooth per controllare l'elenco dei dispositivi Bluetooth e collega il dispositivo.

12. Altro

Non esitare a contattarci all'indirizzo support.eu@dangbei.com.

Avvertenze importanti

- Do not look directly at the projection beam with your eyes, because the strong beam may harm your eyes. RG2 IEC 60825-1:2014
- Do not block or cover the heat dissipation holes of the device to avoid affecting the heat dissipation of the internal parts, and damaging the device.
- Keep away from humidity, exposure, high temperature, low pressure, and magnetic environments.
- Do not place the device in areas susceptible to excessive dust and dirt.
- Place the device in a flat and stable station, and do not place the device on a surface that is prone to vibration.
- Do not allow children to handle the device without supervision.
- Do not place heavy or sharp objects on the device.
- Avoid extreme vibrations, because these may damage the internal components.
- Please use the correct type of battery for the remote control.
- Only use attachments/accessories specified or provided by the manufacturer (such as the exclusive power adapter, bracket, etc.).
- Do not disassemble the device. The device should only be repaired by staff authorized by the manufacturer.
- Place and use the device in a 5-35°C environment.
- La custodia metallica è rivestita con vernice isolante.
- The plug is considered as a disconnected device of the adapter.
- The adapter should be installed near the equipment, and should be easily accessible.
- Protect the power cord from being walked on or pinched, particularly at the plugs, convenience receptacles, and the point where this exits from the device.
- Unplug this device if there are lightning storms or when unused for a long period of time.
- Where the power plug or an appliance coupler is used to disconnect the device, the disconnected device would remain readily operable.
- Never touch the power cable or power connector with wet hands.
- Risk of explosion if battery is replaced by an incorrect type. Dispose of used batteries according to local regulations.

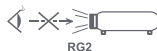

Nota

Google TV is the name of this device's software experience and a trademark of Google LLC. Google, YouTube and Chromecast built-in are trademarks of Google LLC.

This equipment has been tested and found to comply with the limits for a Class B digital device, pursuant to Part 15 of the FCC Rules. These limits are designed to provide reasonable protection against harmful interference in a residential installation.

This equipment generates uses and can radiate radio frequency energy and, if not installed and used in accordance with the instructions, may cause harmful interference to radio communications. However, there is no guarantee that interference will not occur in a particular installation. If this equipment does cause harmful interference to radio or television reception, which can be determined by turning the equipment off and on, the user is encouraged to try to correct the interference by one or more of the following measures:

- Reorient or relocate the receiving antenna.
- Increase the separation between the equipment and receiver.
- Connect the equipment to an outlet on a circuit different from that to which the receiver is connected.
- Consult the dealer or an experienced radio/TV technician for help.

Changes or modifications not expressly approved by the party responsible for compliance could void the user's authority to operate the equipment.

We declare that this device is in compliance with the essential requirements and other relevant provisions of Directive 2014/53/EU. Satisfies all the technical regulations applicable to the product within the scope of UK Radio Equipment Regulations (SI 2017/1206); UK Electrical Equipment (Safety) Regulations (SI 2016/1101); and UK Electromagnetic Compatibility Regulations (SI 2016/1091). This device operating frequency: 2402-2480MHz (EIRP < 20dBm), 2412-2472MHz (EIRP < 20dBm), 5150~5250MHz (EIRP < 23dBm), 5250~5350MHz (EIRP < 20dBm), 5470~5725MHz (EIRP < 27dBm), 5725~5850MHz (EIRP < 13.98dBm).

 We declares that this device is in compliance with the essential requirements and other relevant provisions of Directive 2014/53/EU.

 Satisfies all the technical regulations applicable to the product within the scope of UK Radio Equipment Regulations (SI 2017/1206); UK Electrical Equipment (Safety) Regulations (SI 2016/1101); and UK Electromagnetic Compatibility Regulations (SI 2016/1091).



Manufactured under license from Dolby Laboratories. Dolby, Dolby Audio, and the double-D symbol are trademarks of Dolby Laboratories Licensing Corporation.

NETFLIX

Netflix is a trademark of Netflix, Inc.

THIS DEVICE COMPLIES WITH DHHS RULES 21 CFR CHAPTER I SUBCHAPTER J.
CAN ICES-3 (B)/NMB-3 (B)

This Class B digital apparatus complies with Canadian ICES-003.

Cet appareil numérique de classe B est conforme à la norme canadienne ICES-003.

This device contains licence-exempt transmitter(s)/receiver(s) that comply with Innovation, Science and Economic Development Canada's licence-exempt RSS(s). Operation is subject to the following two conditions:

- (1) This device may not cause interference.
- (2) This device must accept any interference, including interference that may cause undesired operation of the device

L'émetteur/récepteur exempt de licence contenu dans le présent appareil est conforme aux CNR d'Innovation, Sciences et Développement économique Canada applicables aux appareils radio exempts de licence. L'exploitation est autorisée aux deux conditions suivantes :

- 1.L'appareil ne doit pas produire de brouillage;
- 2.L'appareil doit accepter tout brouillage radioélectrique subi, même si le brouillage est susceptible d'en compromettre le fonctionnement.

For projectors only

The distance between user and products should be no less than 20cm.

La distance entre l'utilisateur et le produit ne doit pas être inférieure à 20 cm.

5150-5350MHz band is restricted to indoor use only.

La bande de 5150-5350MHz est réservée à l'usage intérieur.



WARNING: This product can expose you to Lead, which is known to the State of California to cause cancer and birth defects or other reproductive harm. For more information go to www.P65Warnings.ca.gov

Idioma

English	01-19
Deutsch	20-39
Français	40-59
Italiano	60-79
Español	80-99
日本語	100-119

Índice

Leer antes de usar	81
Lista de embalaje	82
Descripción general del proyector	83
Descripción general del control remoto	85
Primeros pasos	86
Ajustes de red	89
Ajustes de enfoque	89
Ajustes de corrección de imagen	90
Modo de altavoz Bluetooth	91
Asistente de Google	91
Chromecast built-in & duplicación de pantalla	92
Entradas	93
Más ajustes	93
Especificaciones	94
Resolución de problemas	94
Precauciones importantes	97
Declaración	98

Leer antes de usar

Le rogamos que lea atentamente las instrucciones del producto:

Gracias por comprar y usar estos productos.

Por motivos de seguridad y en pro de sus intereses, lea atentamente las Instrucciones del producto antes de usarlo.

Acerca de las Instrucciones del producto:

Las marcas registradas y los nombres mencionados en las Instrucciones del producto son propiedad de sus respectivos propietarios. Todas las Instrucciones del producto indicadas sirven únicamente fines ilustrativos. El producto real podría variar debido a posibles mejoras del producto.

No seremos responsables de ninguna lesión, daño a la propiedad u otros daños producidos debido al incumplimiento, por parte del usuario, de las Instrucciones del producto o las respectivas precauciones.

* Dangbei se reserva el derecho a la interpretación y modificación de las Instrucciones del producto.

Lista de embalaje

Antes de usar el producto, compruebe que todos los artículos vengan incluidos en la caja.

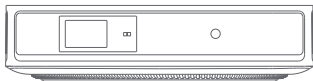

Proyector



Control remoto
(pilas no incluidas)



Adaptador de corriente



Cable de alimentación

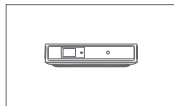

Manual de usuario

Descripción general del proyector

Descripción general y de la interfaz.

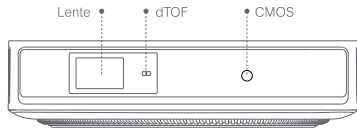

Vista frontal

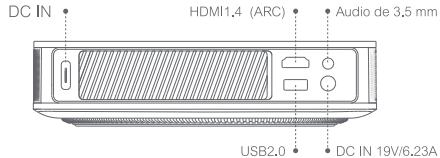

Vista posterior

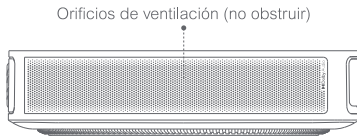

Vista izquierda

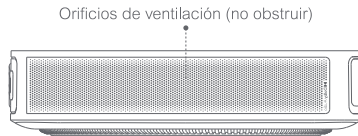

Vista derecha



Vista superior

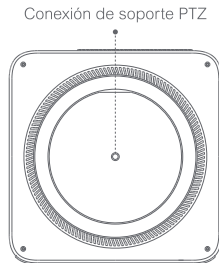

Vista inferior

Guía de indicador LED de botón de encendido

Botón	Estado de LED	Descripción
 Botón de encendido	Encendido	Modo de espera / Encender / Emparejamiento de modo altavoz Bluetooth exitoso/ Apagar
	Apagado	En proyección
	Parpadeo	Actualización de firmware / Emparejamiento de modo altavoz Bluetooth en curso

Descripción general del control remoto

- Abra la tapa del compartimiento de las baterías del control remoto.
- Coloque 2 baterías AAA (**no incluidas**) *.
- Vuelva a colocar la tapa del compartimiento de las baterías.

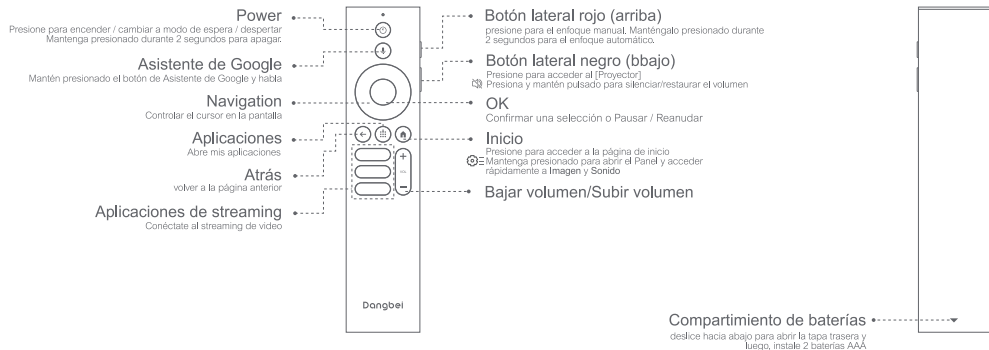

* Inserte las baterías nuevas según las indicaciones de polaridad.

Primeros pasos

1.Colocación

Coloque el proyector sobre una superficie lisa y estable frente a la superficie de proyección.

Se recomienda una superficie de proyección blanca que sea lisa. Siga las instrucciones vertidas a continuación para determinar la distancia entre el proyector y la superficie de proyección, y el tamaño de proyección correspondiente:

Tamaño	Pantalla (largo x ancho)
60 pulgadas	133 x 75 cm 4.36x2.46 ft
80 pulgadas	177 x 100 cm 5.8x 3.28 ft
100 pulgadas	221 x 124 cm 7.25 x 4.06 ft
120 pulgadas	265 x 149 cm 8.69 x 4.88 ft



El tamaño óptimo de proyección recomendado es de 100 pulgadas.

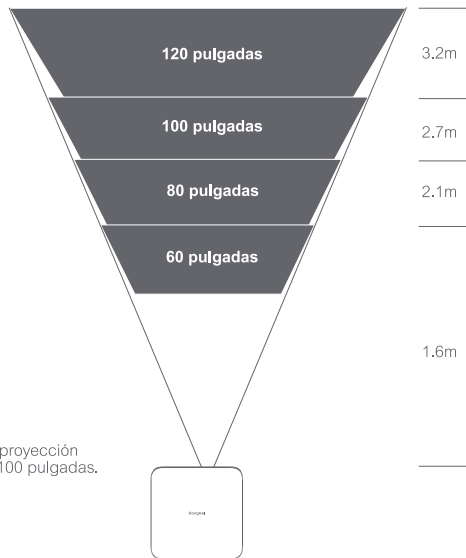

2.Encendido

- ① Conecte el proyector a la toma de corriente.

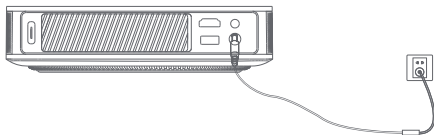

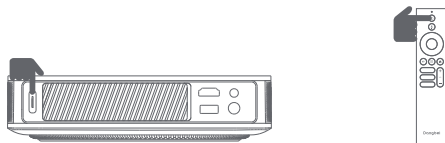

- ② Presione el botón de encendido en el proyector o el control remoto para encender el proyector.



3.Modos de espera / Apagar

Presione el botón de encendido en el proyector o el control remoto para ingresar al modo de espera. Mantenga presionado el botón de encendido en el proyector o el control remoto durante 2 segundos para apagar el proyector.

3. Emparejamiento del control remoto

- Encienda el proyector y espere a que aparezca el mensaje de sincronización con Bluetooth en la pantalla.
- Acerque el control remoto a no más de 10 cm / 0.33 pies del proyector.
- Simultáneamente presione y mantenga presionados los botones  y .
- Suelte los botones cuando la luz indicadora empiece a parpadear.
- Espere hasta oír dos "bips" que indican una sincronización exitosa.

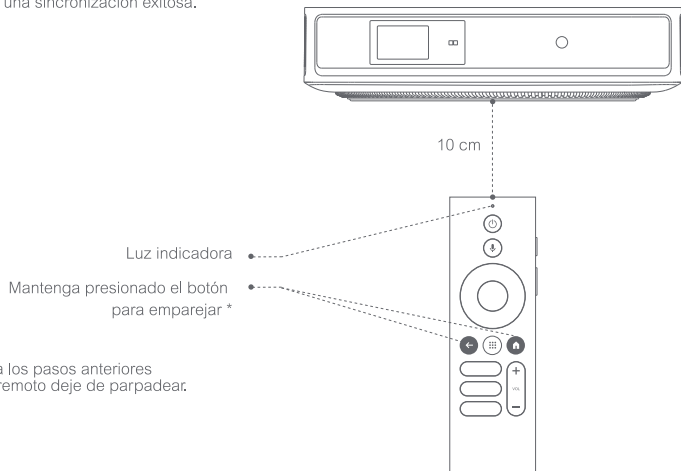

* Si no se logra el emparejamiento, repita los pasos anteriores hasta que la luz indicadora del control remoto deje de parpadear.

Ajustes de red

- Vaya a [Ajustes], seleccione [Red e Internet] y active la función Wifi.
- Elija la red e introduzca la contraseña correcta.



Ajustes de enfoque

Método 1: Para enfoque manual, presione el botón lateral rojo (arriba); para enfoque automático, manténgalo presionado por 2 segundos.

Método 2: Vaya a [Proyector], seleccione [Enfoque] y elija entre enfoque manual o enfoque automático.

Enfoque automático

Para activar la función de enfoque automático seleccione [Enfoque automático]. La imagen se aclarará automáticamente.

Enfoque manual

Seleccione [Enfoque Manual] y utilice los botones de navegación (arriba/abajo) del control remoto, para ajustar la distancia de enfoque y obtener una imagen nítida.



Ajustes de corrección de imagen

1. Corrección trapezoidal

- Vaya a [Proyector] – [Corrección de imagen].
- Seleccione [Corrección trapezoidal automática], y la pantalla se corregirá automáticamente.
- Seleccione [Corrección trapezoidal manual], y use las teclas de navegación para ajustar los cuatro puntos y la forma de la imagen.

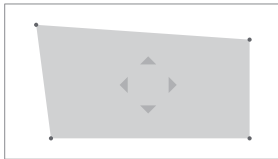

2. Adaptación inteligente de pantalla

- Vaya a [Proyector] -- [Corrección de imagen] y active [Ajustar a la pantalla].
- Siga las instrucciones en pantalla para que la imagen proyectada se adapte de manera automática a la pantalla.

3. Evasión inteligente de obstáculos

- Vaya a [Proyector] -- [Corrección de imagen] – [Avanzado] y active [Evitar obstáculos].
- Siga las instrucciones en pantalla para que la imagen proyectada se ajuste automáticamente de manera tal que evada cualquier objeto sobre la superficie de proyección.

Modo de altavoz Bluetooth

- Vaya a [Ajustes], seleccione [Proyector] y haga clic en [Modo de altavoz Bluetooth].
- Conecte su teléfono al dispositivo de Bluetooth que contenga "DBOD02". Tras modificar el nombre del dispositivo, el nombre de Bluetooth también se sincronizará en conformidad.
- Cuando escuche "Conexión Bluetooth correcta", el proyector podrá reproducir música desde su teléfono.
- Para salir del [Modo de altavoz Bluetooth], mantenga pulsada la tecla  del mando a distancia durante 2 segundos.

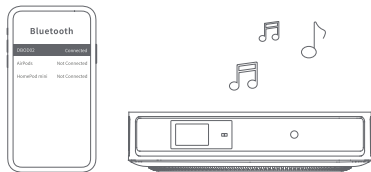

Asistente de Google

Tu televisor es más útil que nunca. Usa tu voz para encontrar películas, transmitir aplicaciones, reproducir música y controlar el televisor. Pregunta a Asistente de Google para encontrar un título específico, buscar por género o recibir recomendaciones personalizadas. Incluso obtén respuestas en pantalla, controla dispositivos inteligentes del hogar y más. Presiona el botón de Asistente de Google en el control remoto para empezar.

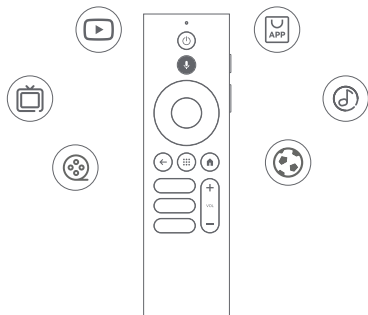

Chromecast built-in & duplicación de pantalla

Puedes transmitir de forma inalámbrica películas, juegos, música y la pantalla de tu dispositivo iOS, macOS, Android™ o Windows al proyector.
*Asegúrate de que el proyector y tu dispositivo estén conectados a la misma red inalámbrica.

1.Chromecast built-in

Para transmitir contenido de la aplicación:

Puedes transmitir contenido desde aplicaciones compatibles con Chromecast como YouTube y otras aplicaciones de streaming.

1. Conecta tu dispositivo y el proyector a la misma red inalámbrica.
2. Abre la aplicación de streaming en tu dispositivo.
3. Reproduce un video y toca el icono de transmisión  en la pantalla del video.
4. Selecciona "DBOD02" para conectar. El proyector mostrará el video desde tu dispositivo.

*Debido a restricciones de derechos de autor, ciertos contenidos no se pueden transmitir al proyector. Puedes transmitir el contenido en el proyector instalando la misma aplicación en él.

2. Duplicación de pantalla a través de AirScreen

Para duplicar la pantalla del dispositivo:

Puedes proyectar la pantalla completa de tu dispositivo en el proyector.

1. Asegúrate de que tanto tu dispositivo como el proyector estén conectados a la misma red inalámbrica.
2. Instala la aplicación AirScreen en el proyector.
3. Abre la aplicación AirScreen y sigue las instrucciones en pantalla para completar el proceso.

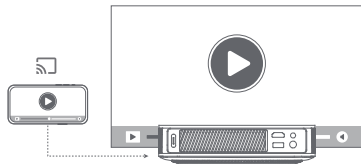

Entradas

- Vaya a [Entradas] – HDMI/HOME/USB.
 - Mire el contenido de diferentes fuentes de señal.
- *La interfaz HDMI de este producto es HDMI 1.4, por lo que no admite entrada de señal de vídeo 4K.

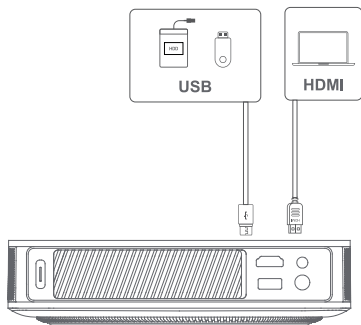

Más ajustes

1. Temperatura del color

Vaya a [Ajustes] -- [Pantalla y sonido] -- [Imagen] – [Temperatura de color] para seleccionar entre [Estándar/Cálido/Cuidado ocular].

2. Modo de proyección

Vaya a [Ajustes] -- [Proyector] -- [Configuración avanzada] – [Modo de proyección] para seleccionar el método de colocación del proyector.

3. Zoom

Vaya a [Ajustes] – [Proyector] – [Corrección de imagen] – [Adaptar imagen] – [Zoom] para reducir el tamaño de la imagen del 100% al 50%.

4. Modo 3D

Antes de habilitar el modo 3D, vaya a [Ajustes] - [Proyector] - [Corrección de imagen] y haga clic en [Restablecer a imagen predeterminada] para restaurar la imagen a su estado predeterminado.

Vaya a [Ajustes] - [Imagen] - [Modo 3D] para habilitar el modo 3D.

*Se recomienda deshabilitar la función [Corrección trapezoidal automática después del movimiento] cuando se habilita el modo 3D a fin de evitar la alteración de la imagen a partir de su estado predeterminado tras mover el proyector, con lo cual el uso del modo 3D podría verse perjudicado.

5. Información del sistema y del producto

Vaya a [Ajustes] -- [Sistema] – [Información] para comprobar la información del sistema y del producto.

Especificaciones

Tecnología de pantalla	0.33 pulgadas, DLP	Versión Bluetooth	5.1
Resolución de pantalla	1920 x 1080	Wi-Fi	Frecuencia dual 2.4/5.0 GHz
Relación de proyección	1.2:1	Dimensiones (L x An x Alt)	195 × 195 × 47.5 mm 7.68 x 7.68 x 1.87 pulgadas
Altavoces	2 x 5 W	Peso	1.28kg /2.82lb

Resolución de problemas

1. No hay salida de sonido

- Comprueba si has presionado dos veces la tecla negra en el costado del control remoto, lo que podría haber silenciado el proyector.
- Compruebe si la interfaz "HDMI ARC" del proyector o Bluetooth están conectadas a algún dispositivo externo de sonido.

2. No hay salida de imagen

- Presiona el botón de encendido ubicado en la parte trasera del proyector. El indicador luminoso del botón de encendido se apagará si el proyector entra con éxito en el modo de proyección.
- Asegúrese de que el adaptador de corriente tenga salida de corriente.

3. Sin red

- Ingresa a los ajustes y averigüe el estado de la conexión de red en las opciones de red.
- Asegúrese de que el cable de red esté correctamente insertado en la interfaz "LAN" del proyector.
- Asegúrese de que el enrutador esté configurado correctamente.

4. Imagen borrosa.

- Ajuste el enfoque o la corrección trapezoidal.
- El proyector y la pantalla/pared deben quedar a una distancia efectiva.
- La lente del proyector no está limpia.

5. La imagen no es rectangular

- Coloque el proyector en sentido perpendicular a la pantalla/pared si no utiliza la función de corrección trapezoidal.
- Utilice la función de corrección trapezoidal para ajustar la pantalla.

6. La corrección trapezoidal automática falló

- Asegúrese de que la cámara/TOF del panel frontal no esté obstruida ni sucia.
- La distancia óptima para una corrección trapezoidal automática es de 2,0 a 4,0m, horizontal $\pm 30^\circ$.

7. Fallo del enfoque automático

- a. Asegúrese de que la cámara/TOF del panel frontal no esté obstruida ni sucia.
- b. La distancia óptima para un enfoque automático es de 2,0 a 4,0m, horizontal $\pm 20^\circ$.

8. Fallo en la protección ocular inteligente

- a. Asegúrese de que la cámara/TOF en el panel frontal no esté bloqueada o sucia.
- b. El rango óptimo de detección se encuentra alrededor del centro de la imagen. De hallarse muy cerca de los bordes, puede que la función de protección ocular no se active.

9. Fallo de la adaptación inteligente de pantalla

- a. Asegúrese de que el proyector esté colocado correctamente, de modo tal que la imagen proyectada se extienda más allá de los bordes de la pantalla.
- b. Asegúrese de que la pantalla de proyección tenga un borde/marco de color a sus cuatro lados, de modo tal que el proyector pueda reconocer dicho marco.
- c. Asegúrese de que el patrón de cuadro rojo esté dentro del marco de la pantalla y no esté siendo obstruido.

10. El control remoto no responde

- a. Asegúrese de que el control remoto se haya sincronizado correctamente a través de Bluetooth. Si el emparejamiento se ha realizado correctamente, la luz LED parpadeará una vez al presionar cualquier botón. Si mantiene presionado cualquier botón, la luz LED permanecerá fija.
- b. Si la sincronización no se realiza correctamente, la luz LED parpadeará tres veces al presionar cualquier botón. Si mantiene presionado cualquier botón, la luz LED parpadeará tres veces y luego permanecerá fija.
- c. Verifica si el indicador de encendido permanece encendido sin presionar ningún botón. Si es así, revisa si algún botón del control remoto está atascado.
- d. Asegúrese de que no haya interferencias u obstrucciones entre el proyector y el control remoto.
- e. Compruebe la polaridad de las baterías y de la instalación.

11. Conecte los dispositivos Bluetooth

Ingrese a los ajustes, abra la opción Bluetooth para comprobar la lista de dispositivos Bluetooth y conecte el dispositivo.

12. Otros

No dude en comunicarse con nosotros a la dirección: support.eu@dangbei.com.

Precauciones importantes

- Do not look directly at the projection beam with your eyes, because the strong beam may harm your eyes. RG2 IEC 60825-1:2014
- Do not block or cover the heat dissipation holes of the device to avoid affecting the heat dissipation of the internal parts, and damaging the device.
- Keep away from humidity, exposure, high temperature, low pressure, and magnetic environments.
- Do not place the device in areas susceptible to excessive dust and dirt.
- Place the device in a flat and stable station, and do not place the device on a surface that is prone to vibration.
- Do not allow children to handle the device without supervision.
- Do not place heavy or sharp objects on the device.
- Avoid extreme vibrations, because these may damage the internal components.
- Please use the correct type of battery for the remote control.
- Only use attachments/accessories specified or provided by the manufacturer (such as the exclusive power adapter, bracket, etc.).
- Do not disassemble the device. The device should only be repaired by staff authorized by the manufacturer.
- Place and use the device in a 5-35°C environment.
- La carcasa de metal está recubierta con pintura aislante.
- The plug is considered as a disconnected device of the adapter.
- The adapter should be installed near the equipment, and should be easily accessible.
- Protect the power cord from being walked on or pinched, particularly at the plugs, convenience receptacles, and the point where this exits from the device.
- Unplug this device if there are lightning storms or when unused for a long period of time.
- Where the power plug or an appliance coupler is used to disconnect the device, the disconnected device would remain readily operable.
- Never touch the power cable or power connector with wet hands.
- Risk of explosion if battery is replaced by an incorrect type. Dispose of used batteries according to local regulations.

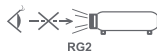

Declaración

Google TV is the name of this device's software experience and a trademark of Google LLC. Google, YouTube and Chromecast built-in are trademarks of Google LLC.

This equipment has been tested and found to comply with the limits for a Class B digital device, pursuant to Part 15 of the FCC Rules. These limits are designed to provide reasonable protection against harmful interference in a residential installation.

This equipment generates uses and can radiate radio frequency energy and, if not installed and used in accordance with the instructions, may cause harmful interference to radio communications. However, there is no guarantee that interference will not occur in a particular installation. If this equipment does cause harmful interference to radio or television reception, which can be determined by turning the equipment off and on, the user is encouraged to try to correct the interference by one or more of the following measures:

- Reorient or relocate the receiving antenna.
- Increase the separation between the equipment and receiver.
- Connect the equipment to an outlet on a circuit different from that to which the receiver is connected.
- Consult the dealer or an experienced radio/TV technician for help.

Changes or modifications not expressly approved by the party responsible for compliance could void the user's authority to operate the equipment.

We declare that this device is in compliance with the essential requirements and other relevant provisions of Directive 2014/53/EU. Satisfies all the technical regulations applicable to the product within the scope of UK Radio Equipment Regulations (SI 2017/1206); UK Electrical Equipment (Safety) Regulations (SI 2016/1101); and UK Electromagnetic Compatibility Regulations (SI 2016/1091). This device operating frequency: 2402-2480MHz (EIRP < 20dBm), 2412-2472MHz (EIRP < 20dBm), 5150~5250MHz (EIRP < 23dBm), 5250~5350MHz (EIRP < 20dBm), 5470~5725MHz (EIRP < 27dBm), 5725~5850MHz (EIRP < 13.98dBm).

 We declares that this device is in compliance with the essential requirements and other relevant provisions of Directive 2014/53/EU.

 Satisfies all the technical regulations applicable to the product within the scope of UK Radio Equipment Regulations (SI 2017/1206); UK Electrical Equipment (Safety) Regulations (SI 2016/1101); and UK Electromagnetic Compatibility Regulations (SI 2016/1091).



Manufactured under license from Dolby Laboratories. Dolby, Dolby Audio, and the double-D symbol are trademarks of Dolby Laboratories Licensing Corporation.

NETFLIX

Netflix is a trademark of Netflix, Inc.

THIS DEVICE COMPLIES WITH DHHS RULES 21 CFR CHAPTER I SUBCHAPTER J.

CAN ICES-3 (B)/NMB-3 (B)

This Class B digital apparatus complies with Canadian ICES-003.

Cet appareil numérique de classe B est conforme à la norme canadienne ICES-003.

This device contains licence-exempt transmitter(s)/receiver(s) that comply with Innovation, Science and Economic Development Canada's licence-exempt RSS(s). Operation is subject to the following two conditions:

(1) This device may not cause interference.

(2) This device must accept any interference, including interference that may cause undesired operation of the device

L'émetteur/récepteur exempt de licence contenu dans le présent appareil est conforme aux CNR d'Innovation, Sciences et Développement économique Canada applicables aux appareils radio exempts de licence. L'exploitation est autorisée aux deux conditions suivantes :

1.L'appareil ne doit pas produire de brouillage;

2.L'appareil doit accepter tout brouillage radioélectrique subi, même si le brouillage est susceptible d'en compromettre le fonctionnement.

For projectors only

The distance between user and products should be no less than 20cm.

La distance entre l'utilisateur et le produit ne doit pas être inférieure à 20 cm.

5150-5350MHz band is restricted to indoor use only.

La bande de 5150-5350MHz est réservée à l'usage intérieur.



WARNING: This product can expose you to Lead, which is known to the State of California to cause cancer and birth defects or other reproductive harm. For more information go to www.P65Warnings.ca.gov

言語

English	01-19
Deutsch	20-39
Français	40-59
Italiano	60-79
Español	80-99
日本語	100-119

目次

使用前に必ずお読みください.....	101
梱包内容.....	102
プロジェクター外観.....	103
リモコン概要.....	105
操作.....	106
ネットワーク設定.....	109
フォーカス設定.....	109
イメージ補正設定.....	110
Bluetoothスピーカーモード.....	111
Google アシスタント	111
Chromecast built-in & スクリーンミラーリング.....	112
入力.....	113
その他.....	113
仕様.....	114
トラブルシューティング.....	114
重要な注意事項.....	117
ステートメント.....	118

使用前に必ずお読みください

プロジェクターを操作する前に、この取扱説明書をお読みください。

この度は弊社製品をお買い上げ頂き誠にありがとうございます。

本装置を安全にご使用いただくために、このガイドおよび装置のマークに記載されている指示に従ってください。

製品の注意事項については次のとおりです。

本製品取扱書に記載されている商標ならびに製品名は弊社に帰属します。

表示されているすべてのイラストは、あくまでも商品説明のためのものです。製品の向上のため、実際の製品とは異なる場合があります。

お客様が本取扱説明書や注意事項を守らなかったことにより発生した人身事故、物損事故、その他の損害について、弊社では一切の責任を負いません。

* Dengbeiでは本取扱説明書の解釈ならびに変更する権利を留保します。

梱包内容

丁寧に開梱し、次に示すものがすべて揃っていることを確認してください。不足しているものがある場合は、お買い上げの販売店にご連絡ください。

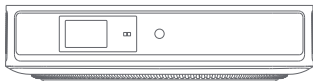

プロジェクター本体



リモコン (電池別売り)



電源アダプター



電源ケーブル

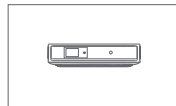

取扱説明書

プロジェクター外観

概要及びインターフェースの説明。

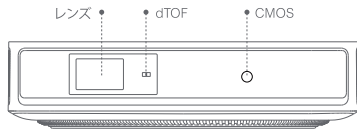

前面

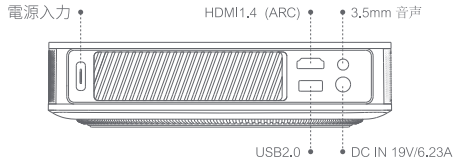

後面

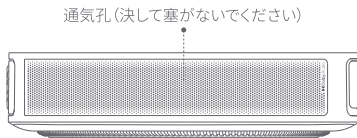

左側面

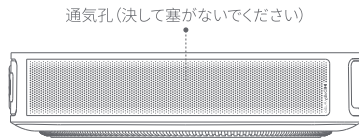

右側面

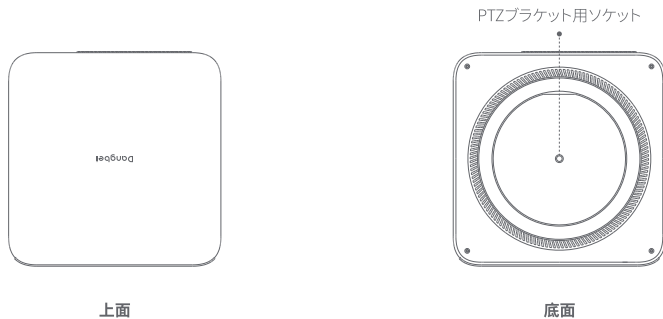

電源ボタン/LEDインジケータ概要		
ボタン	LEDステータス	説明
 電源ボタン	オン	スタンバイモード/電源オン/Bluetoothスピーカーモードのペアリング成功/電源オフ
	オフ	投影中
	点滅	ファームウェアのアップデート/Bluetoothスピーカーモードのペアリング中

リモコン概要

- ・リモコン本体の電池カバーを開けます。
- ・単4電池2本をセットします(お客様で電池をご準備ください)*
- ・電池カバーをもとに戻します。

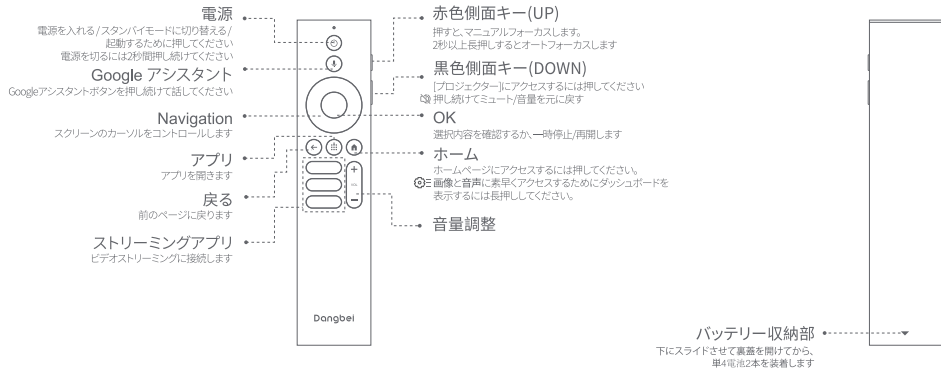

* 極性表示に従って 新しい電池をセットしてください。

操作

1. 設置方法

プロジェクターは安定した平らな面で、投影面の手前に置きます。
投影面は、平らで白いものを推奨します。
以下の手順で、プロジェクターと投写面との距離、
対応する投写サイズを確認ください。

寸法	スクリーン 長さ(L)×幅(W)
60 インチ	133 x 75 cm 4.36x2.46 ft
80 インチ	177 x 100 cm 5.8x 3.28 ft
100 インチ	221 x 124 cm 7.25 x 4.06 ft
120 インチ	265 x 149 cm 8.69 x 4.88 ft



投影サイズは100インチが最適です。

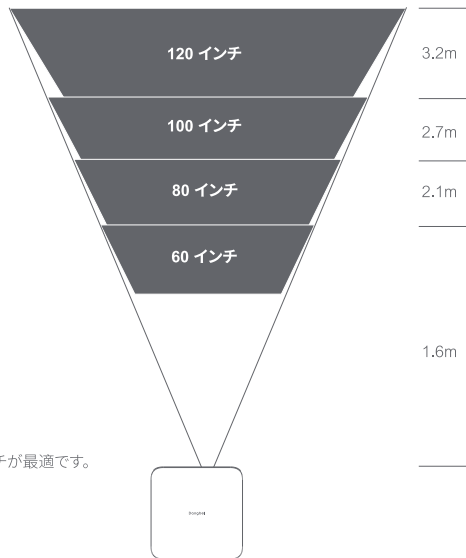

2.電源オン

- ① プロジェクターを電源コンセントに接続します。

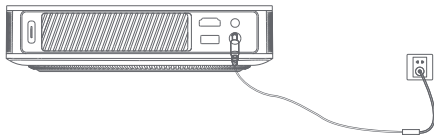

- ② プロジェクターまたはリモコンの電源ボタンを押して、プロジェクターをオンにしてください。

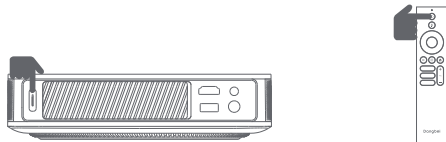

3.スタンバイモード / 電源オフ

プロジェクターまたはリモコンの電源ボタンを押して、スタンバイモードに入ります。
プロジェクターまたはリモコンの電源ボタンを2秒間押し続けてください。プロジェクターがオフになります。

3. リモコンのペアリング

- ・ プロジェクターの電源を入れ、画面にBluetoothペアリングのプロンプトが表示されるまで待ちます。
- ・ リモコンをプロジェクターから10cm(0.33ft)以内に近づけます。
- ・ ◀ キーと 🏠 キーを同時に押し続けます。
- ・ インジケータライトが点滅し始めてからキーを離します。
- ・ ペアリングが成功したことを示す「ピーブ音」が2回鳴るまで待ちます。

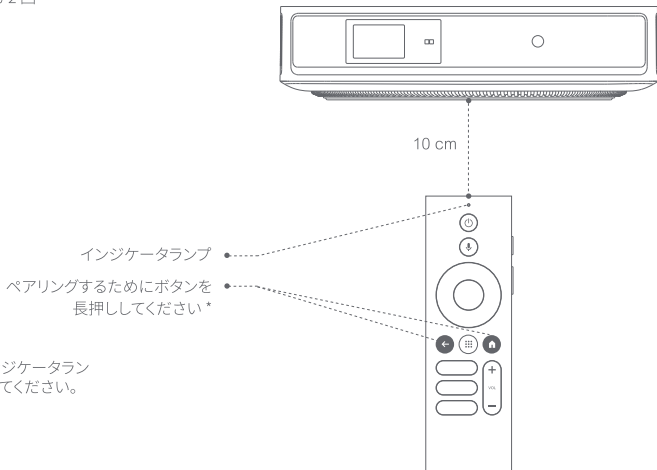

* ペアリングが成功しない場合、リモコンのインジケータランプが点滅をやめるまで上記の手順を繰り返してください。

ネットワーク設定

- ・「設定」>「ネットワークとインターネット」を選択し、Wi-Fi機能を立ち上げます。
- ・ネットワークを選択し、正しいパスワードを入力します。



フォーカスセッティング

- 方法1: 赤色側面キー(UP)を押すとマニュアルフォーカスします。2秒以上長押しするとオートフォーカスします。
- 方法2: 「プロジェクター」>「フォーカス」を選択し、マニュアルフォーカスがオートフォーカスを選択します。

オートフォーカス

「自動フォーカス」を選択すると、オートフォーカス機能が起動します。画像は自動で鮮明になります。

マニュアルフォーカス

「手動フォーカス」を選択して、リモコンのナビゲーションキー(UP/DOWN)を使ってピント距離を調整し、画像を鮮明にします。



キーストーンの自動補正

1.自動台形補正

- ・「プロジェクター」>「画像補正」に進みます。
- ・[自動台形補正]を選択すると、画面が自動的に補正されます。
- ・[手動台形補正]を選択して、4つのポイントと画像の形状を調整するためにナビゲーションキーを使用します。

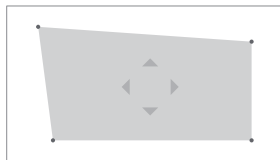

2.スマートスクリーンフィット

- ・「プロジェクター」>「画像補正」に進み、「自動スクリーンフィット」を立ち上げます。
- ・画面の指示に従って、投影されるイメージをスクリーンに合わせて自動的に調整します。

3.スマート障害物回避

- ・「プロジェクター」>「画像補正」>「詳細」に進み、「障害物回避」機能を立ち上げます。
- ・画面の指示に従って、投写面上の物体を避けるように投写イメージを自動調整します。

Bluetoothスピーカーモード

- ・「設定」>「プロジェクター」を選択し、「Bluetoothスピーカーモード」をクリックします。
- ・スマートフォンから「DBOD02」を含むBluetooth名を持つデバイスに接続します。デバイス名を変更した後、Bluetooth名もそれに応じて同期されます。
- ・「Bluetooth接続成功」と表示されると、プロジェクターはスマートフォンから音楽を再生することができます。
- ・リモコンの  キーを2秒間長押しして、「Bluetoothスピーカーモード」を終了します。

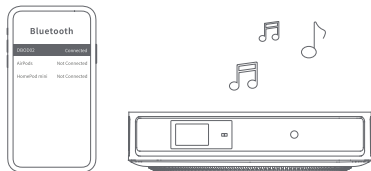

Google アシスタント

あなたのテレビはこれまで以上に便利です。声を使って映画を検索したり、アプリをストリーミングしたり、音楽を再生したり、テレビをコントロールしたりできます。Googleアシスタントに特定のタイトルを検索したり、ジャンルで検索したり、パーソナライズされたおすすめを得たりできます。画面上で回答を受け取ったり、スマートホームデバイスをコントロールしたりすることもできます。開始するには、リモコンのGoogleアシスタントボタンを押してください。

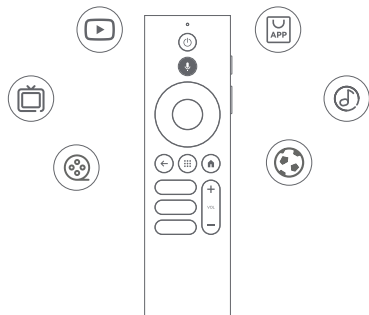

Chromecast built-in & スクリーンミラーリング

iOS、macOS、Android™、またはWindowsデバイスからプロジェクターに映画、ゲーム、音楽、および画面をワイヤレスでキャストすることができます。
*プロジェクターとデバイスが同じワイヤレスネットワークに接続されていることを確認してください。

1.Chromecast built-in

アプリ内コンテンツをキャストするには：

YouTubeやその他のストリーミングアプリなど、Chromecast対応のアプリからコンテンツをキャストすることができます。

1. デバイスとプロジェクターを同じ無線ネットワークに接続します。
2. デバイス上のストリーミングアプリを開きます。
3. ビデオを再生し、ビデオ画面のキャストアイコン  をタップします。
4. 「DBOD02」を選択して接続します。プロジェクターはデバイスからビデオを表示します。

*著作権の制約により、特定のコンテンツはプロジェクターにキャストすることができません。

同じアプリケーションをプロジェクターにインストールすることで、コンテンツをプロジェクター上でストリーミングできます。

AirScreenを使用した画面ミラーリング

デバイスの画面をキャストするには：

デバイスの全画面をプロジェクターに映すことができます。

1. デバイスとプロジェクターが同じ無線ネットワークに接続されていることを確認してください。
2. プロジェクターにAirScreenアプリをインストールしてください。
3. AirScreenアプリを開き、画面上の指示に従ってプロセスを完了してください。

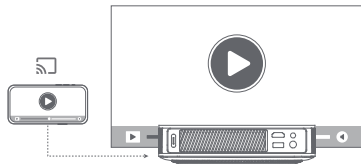

入力

- ・「入力ソース」からHDMI/HOME/USBを選択します。
- ・異なる信号ソースからコンテンツを視聴します。
- ＊この製品のHDMIインターフェースはHDMI 1.4であり、4Kビデオ信号の入力はサポートされていません。

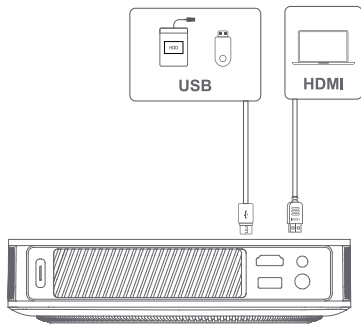

その他

1.色温度

「設定」>「ディスプレイと音」>「画像」>「色温度」と進み、「標準 / ウォーム / Eye Care」のいずれかを選択します。

2.プロジェクションモード

「設定」>「プロジェクター」>「詳細設定」>「プロジェクションモード」と進み、プロジェクターの設置方法を選択します。

3.ズーム

「設定」>「プロジェクター」>「画像補正」>「画像変換」>「ズーム」と進むと、画像サイズを100%から50%に縮小できます。

4.3Dモード

3Dモードを有効にする前に、「設定」→「プロジェクター」→「画像補正」に移動し、「初期設定の画像に戻す」をクリックして画像をデフォルト状態に戻します。「設定」→「画像」→「3Dモード」に移動して3Dモードを有効にします。
＊3Dモードを有効にする際には、プロジェクターを移動した後に画像を変更しないように、「移動後の自動台形補正」機能を無効にすることをお勧めします。これにより、3Dモードの使用が妨げられる可能性があります。

5.システムおよび製品情報

「設定」>「システム」>「デバイス情報」と進むと、システムと製品情報が確認できます。

仕様

ディスプレイ技術	DLP 0,33インチ	Bluetoothバージョン	5.1
ディスプレイ解像度	1920 x 1080	Wi-Fi	2.4/5.0 GHzデュアル周波数
スローレシオ	1.2:1	寸法(LxWxH)	195 × 195 × 47.5 mm 7.68 x 7.68 x 1.87 インチ
スピーカー	2 x 5 W	重量	1.28kg /2.82lb

トラブルシューティング

1. 音声が出力されない

- リモコンの黒いサイドキーを2回押したかどうかを確認してください。それによってプロジェクターがミュートになる可能性があります。
- プロジェクターのインターフェースが「HDMI ARC」になっているかどうか、Bluetoothが外部オーディオ端末に接続されているかどうか確認します。

2. イメージが出力されない

- プロジェクターの背面にある電源ボタンを押してください。プロジェクターが正常に投影モードに入ると、電源ボタンのインジケータライトが消灯します。
- 電源アダプターに電源が出力されていることを確認します。

3. ネットワークにつながらない

- 「設定」に入り、ネットワークオプションのネットワーク接続状態を確認します。
- プロジェクターのインターフェース「LAN」にLANケーブルがきちんと挿入されているか確認します。
- ルーターの設定が正しいかどうか確認します。

4. 画像がぼやけている

- フォーカスもしくは台形補正を調整します。
- プロジェクターとスクリーン/壁が有効な距離に置かれているかどうか確認します。
- プロジェクターのレンズが汚れているため、きれいに拭きます。

5. 画像が正方形になっていない

- 台形補正機能を使用していない場合、スクリーン/壁に対してプロジェクターを垂直に設置します。
- 自動台形補正機能を使ってディスプレイを調整します。

6. 自動台形補正に失敗する

- 前面パネルのカメラ/TOFがブロックされていないかまたは汚れていないか確認します。
- 最適な自動台形補正の距離は2.0~4.0m、水平度は $\pm 30^\circ$ です。

7.オートフォーカスに失敗する

- a. 前面パネルのカメラ/TOFが遮蔽されていないかまたは汚れていないか確認します。
- b. 最適なオートフォーカスの距離は2.0~4.0m、水平度は±20°です。

8.スマートアイ保護が失敗しました

- a. フロントパネルのカメラ/TOFがブロックされていないか、汚れていないことを確認してください。
- b. 最適な検出範囲は画像の中心にあります。端に近づきすぎるとアイ保護機能が作動しない可能性があります。

9.スマートスクリーンフィットに失敗する

- a. プロジェクターが正確に位置決めされているかどうか確認します。投影されたイメージがスクリーンの端まで拡大されています。
- b. プロジェクターがフレームを認識できるように、プロジェクションスクリーンの4辺に色のついたボーダー/フレームがあることを確認します。
- c. 赤枠のパターンが画面枠内にあり、遮蔽されていないことを確認します。

10.リモコンが反応しない

- a. リモコンはBluetooth経由で正常にペアリングされていることを確認してください。ペアリングが成功していると、どのボタンを押してもLEDライトが一回点滅します。どのボタンを長押ししても、LEDライトは点灯したままになります。
- b. ペアリングが成功していなければ、どのボタンを押してもLEDライトが三回点滅します。どのボタンを長押ししても、LEDライトは三回点滅した後点灯したままになります。
- c. どのボタンも押さずに電源インジケータが点灯しているかを確認してください。もしそうであれば、リモコンのボタンが詰まっていないかを確認してください。
- d. プロジェクターとリモコンの間に遮蔽物や障害がないかどうか確認してください。
- e. 電池と電池の極性を確認してください。

11. Bluetooth端末との接続

「設定」に入り、「Bluetoothオプション」を開いてBluetooth端末リストを確認し、端末を接続してください。

12.その他

弊社support.jp@dangbei.com.までお気軽にお問い合わせください。

重要な注意事項

- ・強い光で目を痛めることがありますので、投影されるビームを直接目で見ないでください。RG2 IEC 62471-5:2015
- ・内部部品の放熱に影響を与え、本体が壊れる恐れがあるため、本体の放熱孔を塞いだり、覆ったりしないでください。
- ・高温、直射日光、高温、低圧、磁気のある環境には置かないでください。
- ・ちりやほこりの多い場所には置かないでください。
- ・平らで安定した台に置き、振動が発生しやすい場所には置かないでください。
- ・保護者のいないところでお子様を取り扱わないようにしてください。
- ・本体の上に重いものや鋭利なものを置かないでください。
- ・内部の部品を損傷させる可能性があるため、極端な振動は避けてください。
- ・リモコンには正しいタイプの電池をお使いください。
- ・付属品やアクセサリ（専用電源アダプター、ブラケットなど）にはメーカーが指定または提供するもののみをお使いください。
- ・本体を自らの手で分解しないでください。本体の修理はメーカーで認定された作業者のみが行ってください。
- ・本体は5～35°Cの環境下に置き、使用してください。
- ・金属のケーシングは絶縁塗料でコーティングされています。
- ・アダプターのプラグが挿されていないければ、電源が入りません。
- ・アダプターは本体の近くに置き、簡単に取扱いできるようにする必要があります。
- ・電源コード、特にプラグやコンセント、本体から出る部分などは、歩いて引っ掛けたりしないように保護してください。
- ・雷雨になっているとき、または長期間使用しないときは、本体のプラグを抜いてください。
- ・電源プラグや電気器具のカプラから本体の電源を切断した場合、本体を簡単に操作できるような状態にしてください。
- ・ぬれた手で電源コードやアダプターを決して触らないでください。
- ・電池を誤ったタイプに交換すると爆発の危険があります。使用済みの電池は地域の規制に従って廃棄してください。

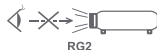

ステートメント

Google TV は、本デバイスのソフトウェア機能の名称であり、Google LLC の商標です。
Google、YouTube、Chromecast built-in は Google LLC の商標です。

This equipment has been tested and found to comply with the limits for a Class B digital device, pursuant to Part 15 of the FCC Rules. These limits are designed to provide reasonable protection against harmful interference in a residential installation.

This equipment generates uses and can radiate radio frequency energy and, if not installed and used in accordance with the instructions, may cause harmful interference to radio communications. However, there is no guarantee that interference will not occur in a particular installation. If this equipment does cause harmful interference to radio or television reception, which can be determined by turning the equipment off and on, the user is encouraged to try to correct the interference by one or more of the following measures:

- Reorient or relocate the receiving antenna.
- Increase the separation between the equipment and receiver.
- Connect the equipment to an outlet on a circuit different from that to which the receiver is connected.
- Consult the dealer or an experienced radio/TV technician for help.

Changes or modifications not expressly approved by the party responsible for compliance could void the user's authority to operate the equipment.

We declare that this device is in compliance with the essential requirements and other relevant provisions of Directive 2014/53/EU. Satisfies all the technical regulations applicable to the product within the scope of UK Radio Equipment Regulations (SI 2017/1206); UK Electrical Equipment (Safety) Regulations (SI 2016/1101); and UK Electromagnetic Compatibility Regulations (SI 2016/1091). This device operating frequency: 2402-2480MHz (EIRP < 20dBm), 2412-2472MHz (EIRP < 20dBm), 5150~5250MHz (EIRP < 23dBm), 5250~5350MHz (EIRP < 20dBm), 5470~5725MHz (EIRP < 27dBm), 5725~5850MHz (EIRP < 13.98dBm).

 We declares that this device is in compliance with the essential requirements and other relevant provisions of Directive 2014/53/EU.

 Satisfies all the technical regulations applicable to the product within the scope of UK Radio Equipment Regulations (SI 2017/1206); UK Electrical Equipment (Safety) Regulations (SI 2016/1101); and UK Electromagnetic Compatibility Regulations (SI 2016/1091).



Manufactured under license from Dolby Laboratories. Dolby, Dolby Audio, and the double-D symbol are trademarks of Dolby Laboratories Licensing Corporation.

NETFLIX

Netflix is a trademark of Netflix, Inc.

THIS DEVICE COMPLIES WITH DHHS RULES 21 CFR CHAPTER I SUBCHAPTER J.

CAN ICES-3 (B)/NMB-3 (B)

This Class B digital apparatus complies with Canadian ICES-003.

Cet appareil numérique de classe B est conforme à la norme canadienne ICES-003.

This device contains licence-exempt transmitter(s)/receiver(s) that comply with Innovation, Science and Economic Development Canada's licence-exempt RSS(s). Operation is subject to the following two conditions:

(1) This device may not cause interference.

(2) This device must accept any interference, including interference that may cause, undesired operation of the device

L'émetteur/récepteur exempt de licence contenu dans le présent appareil est conforme aux CNR d'Innovation, Sciences et Développement économique Canada applicables aux appareils radio exempts de licence. L'exploitation est autorisée aux deux conditions suivantes :

1.L'appareil ne doit pas produire de brouillage;

2.L'appareil doit accepter tout brouillage radioélectrique subi, même si le brouillage est susceptible d'en compromettre le fonctionnement.

For projectors only

The distance between user and products should be no less than 20cm.

La distance entre l'utilisateur et le produit ne doit pas être inférieure à 20 cm.

5150-5350MHz band is restricted to indoor use only.

La bande de 5150-5350MHz est réservée à l'usage intérieur.

Customer Support :

(US/CA) support@dangbei.com

(EU) support.eu@dangbei.com

(JP) support.jp@dangbei.com

For FAQs, user guides in multiple languages to download, and more information, please visit us.dangbei.com

Dangbei

Smart Projector

Model : DBOD02

Input : 19V \approx 6.32A

USB Output : 5V \approx 1.0A

Manufacturer : Shenzhen Dangs Science and Technology Co., Ltd.

Address : 901, GDC Building, Gaoxin Mid 3rd Road, Maling Community, Yuehai Sub-district,
Nanshan District, Shenzhen, China.