

PHILIPS

dynalite 

Controls

Room Automation  
System (PDRAS)



Get sophisticated  
controls from a **simple**  
**out-of-the-box solution**

# Flexible, scalable, and cost-effective



## **Philips Dynalite Room Automation System (PDRAS)**

brings energy management, occupancy detection, daylight harvesting, and code-compliance for multi-zone spaces, with simple, intuitive controls and optional ethernet connectivity for plug-and-play installation.

The PDRAS uses the latest generation of Dynalite hardware, pre-programmed and configured in our factory to work seamlessly together. Simple plenum installation with pluggable user interfaces and sensors ensures industry-leading performance right out of the box.



# Plug and play control

**Single-box solution** – Assembled, programmed, and tested in the factory to provide complete out-of-the-box functionality.



**Stations with large buttons and simple labelling** – Ensures easy operation for non-technical users.



**Ethernet connectivity** – Enables network access to the your LAN for centralized monitoring and management (future provision for -E variants only, not enabled at release)



**Networked multifunction sensor** – Reduce installation complexity and ceiling/plenum clutter with combined occupancy and light level (lux) detection.

**Integrated daylight harvesting** – Multifunction sensors micro-adjust lighting levels to meet energy management regulations without disrupting occupant comfort.

**Extend the coverage** – Add up to three extra PIR sensors and/or one long range ultrasonic sensor per room.



**Software-selectable 1-10V / DALI control** – Although factory-set for 1-10V, each control channel can be individually configured for DALI operation using Dynalite's System Builder commissioning software on a connected PC or laptop.





The Room Automation System is ideal for classrooms, cafeterias, gymnasiums, libraries, open offices with multiple neighborhoods, meeting rooms, and more.





Control strategies	Description
Scene setting	Minimize startup and configuration setup with plug and play behaviors and default scenes that are optimized to support a range of functional spaces.
Distributed intelligence	Controllers, sensors and user interfaces intelligently communicate within the associated area for more flexibility and responsiveness; eliminating any single point of failure.
Multi-zone control	Control up to 5 switching and 4 dimming zones. All the dimming outputs are software programmable between 0-10V and DALI broadcast.
Manual ON & Automatic shutoff with sensors	System is programmed by default for Manual ON and after 15 minutes of vacancy, system will dim all lighting to 15% and after an additional 5 minute grace period will turn them OFF.
Daylight Regulation	Depending on the available daylight the system will adjust the room lighting to a set target in a very subtle manner to avoid any distractions.
High end trim	Get instant savings as the system is configured from the factory to reduce maximum light output instantly by 15%.
Continuous dimming & scene settings	To support various functional activities, trigger different scenes and override light levels via an intuitive and sleek user interface.
Plug load control	Automatically turn OFF receptacles in the space upon vacancy.
Digitally Addressable lighting	Each lighting control zone and control device is assigned a unique digital address for granular configuration.
Flexibility	Customize the setup to suit your needs and alter system parameters, sensor timeouts, scene levels, etc through a software configuration tool
Networking, Integration & Software	Optionally network multiple spaces together for central management & monitoring capabilities via the System Manager software. Integrate lighting with other systems in the building such as BMS, security, fire alarm, blinds etc. to optimize building operations.

## Get code compliancy with automated sensor behaviors such as occupancy sensing, daylight harvesting, manual control, and more.

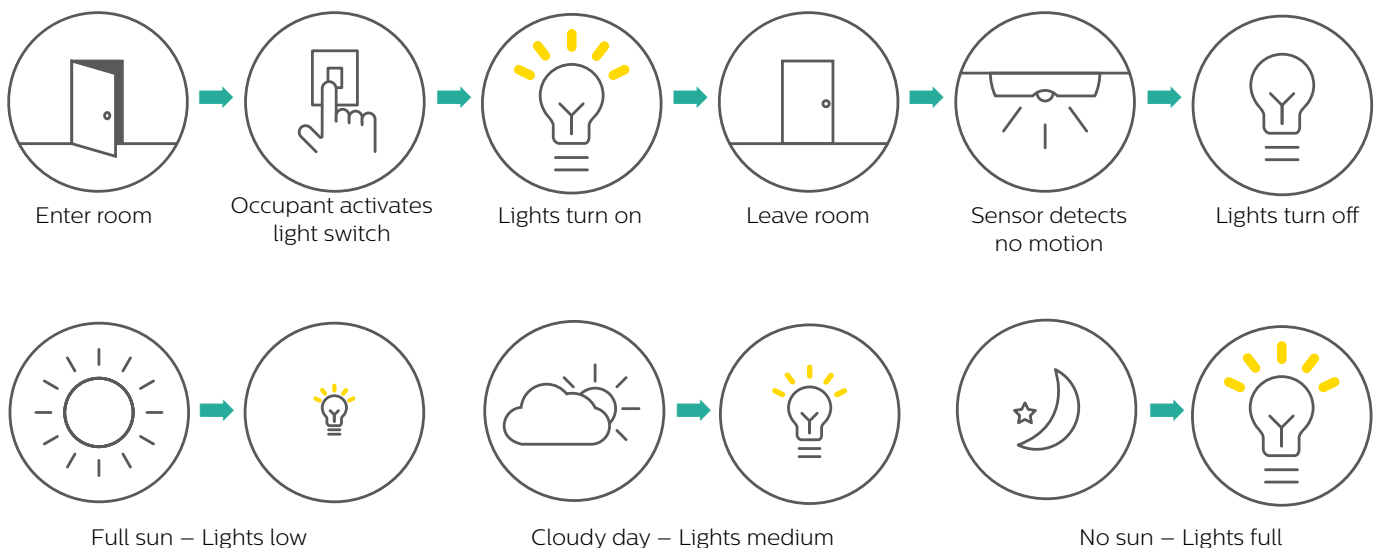

# Office application



**DUS360CS sensor - occupancy & daylight**

– RS-485 DyNet

– **Switching and dimming zone output**



**Antumbra 6 button user interface**

## Top Floor Zones

- 1 General lighting zone
- 2 Relaxation zone
- 3 Sconce zone



**Antumbra 4 button user interface (optional)**

## Bottom Floor Zones

- 1 Office nook zone
- 2 Lobby zone
- 3 Waiting area zone
- 4 Plug load zone

# Classroom application

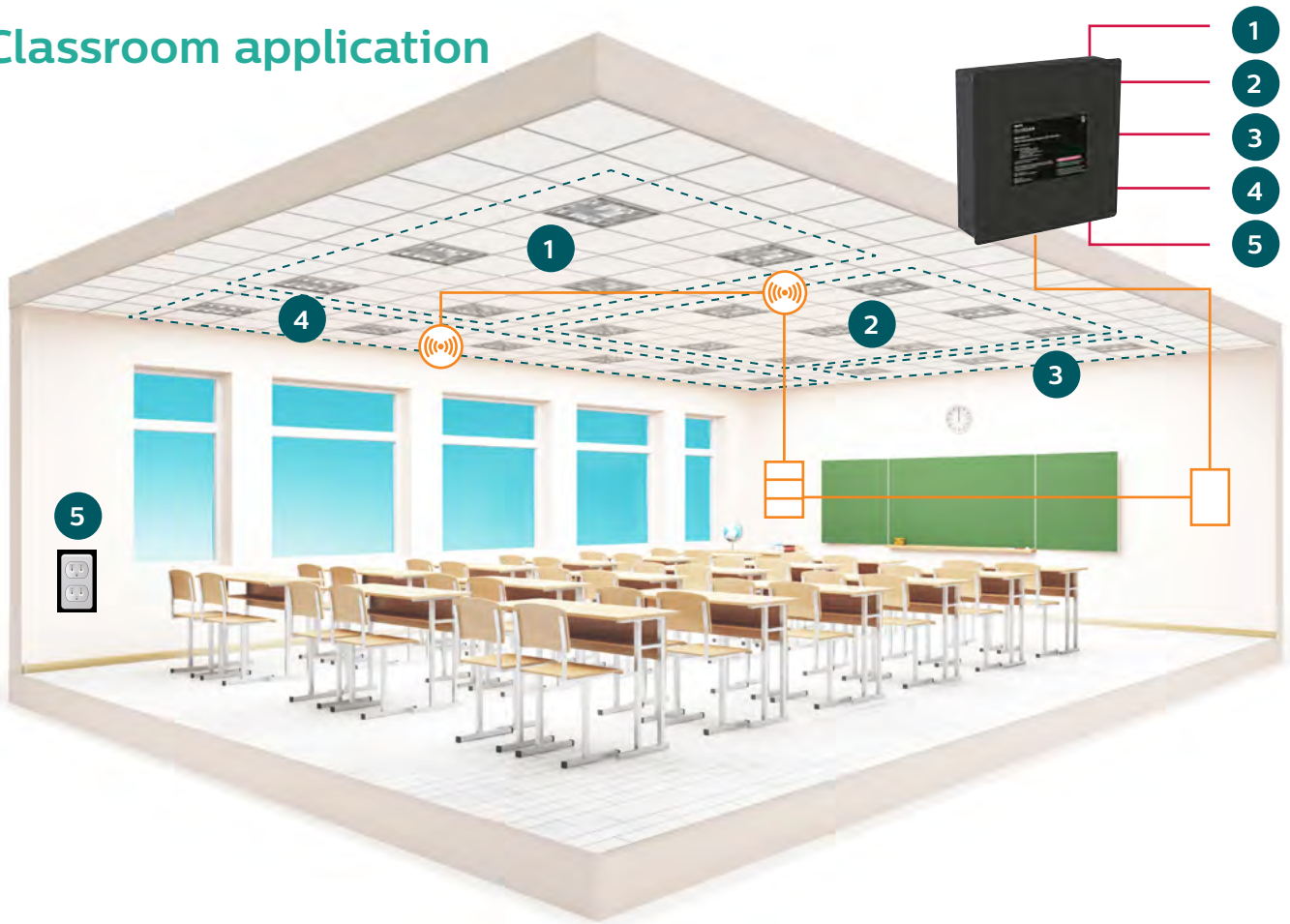

**DUS360CS sensor - occupancy & daylight**

– RS-485 DyNet

– Switching and dimming zone output



**Antumbra 2 button user interface**

## Zones

- 1 General lighting zone A
- 2 General lighting zone B
- 3 Presentation zone
- 4 Window zone
- 5 Plug load zone



**Antumbra 6 button user interface**

# Single-Room System layout and component ordering information

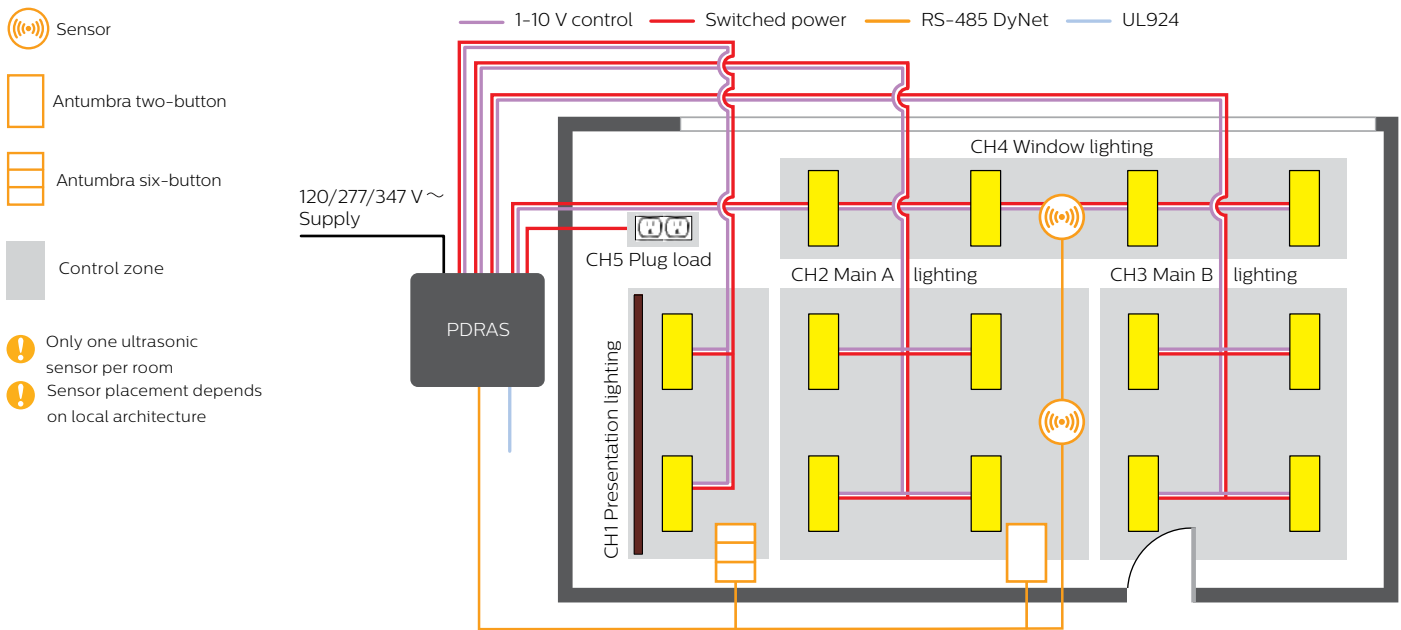

Only one ultrasonic sensor per room  
Sensor placement depends on local architecture

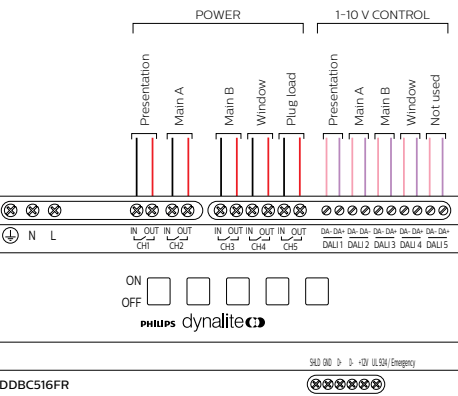

**Single-room advantages:**

- Ideal for spaces where you need 5 control zones per room
- Maximum control per room

Single-Room Controller	12NC
PDRAS120 (120 VAC)	913703348509
PDRAS277 (277/347 VAC)	913703348609
PDRAS120-E (120 VAC + Ethernet)	913703348709
PDRAS277-E (277/347 VAC + Ethernet)	913703348809
User Interfaces	12NC
DACM-PDRAS (Antumbra comms module)	913703349609
PA6BPA-WW-L-PDRAS	913703349709
PA4BPA-WW-L-PDRAS	913703349809
PA2BPA-WW-L-PDRAS	913703349909
Single Room Sensors	12NC
DUS360CS-PDRAS-ML (Motion + lux sensor)	913703349609
DUS360CS-PDRAS-M (Motion only sensor)	913703350609
DUS804CS-UP-NA-PDRAS-M (Ultrasonic motion sensor)	913703350909
Spare RJ45 Connectors*	12NC
DINGUS-DUS-RJ45-DUAL (Dual RJ45 sensor connector - pack of 10)	913703064409
DINGUS-UI-RJ45-DUAL (Dual RJ45 DACM connector - pack of 10)	913703334609

\* Each sensor and DACM is supplied with a dual RJ45 connector.



# Dual-Room System layout and component ordering information

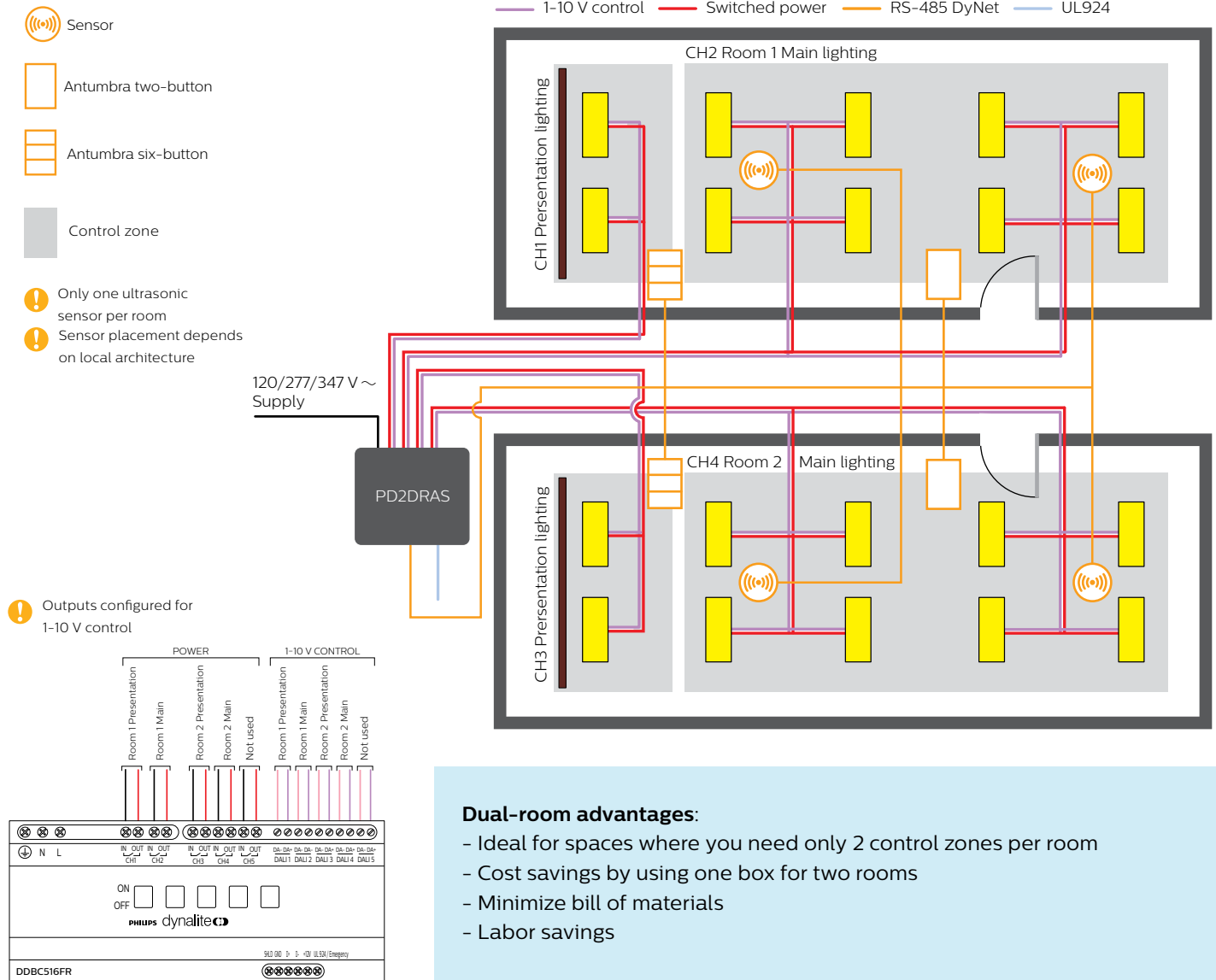

**Dual-room advantages:**

- Ideal for spaces where you need only 2 control zones per room
- Cost savings by using one box for two rooms
- Minimize bill of materials
- Labor savings

Dual-Room Controller	12NC
PD2DRAS120 (120 VAC)	913703349109
PD2DRAS277 (277/347 VAC)	913703349209
PD2DRAS120-E (120 VAC + Ethernet)	913703349309
PD2DRAS277-E (277/347 VAC + Ethernet)	913703349409
User Interfaces	12NC
DACM-PDRAS (Antumbra comms module)	913703349609
PA6BPA-WW-L-PDRAS	913703349709
PA4BPA-WW-L-PDRAS	913703349809
PA2BPA-WW-L-PDRAS	913703349909
Dual Room Sensors	12NC
DUS360CS-PD2DRAS-ML (Motion + lux sensor)	913703350709
DUS360CS-PD2DRAS-M (Motion only sensor)	913703350809
DUS804CS-UP-NA-PD2DRAS-M (Ultrasonic motion sensor)	913703351009
Spare RJ45 Connectors*	12NC
DINGUS-DUS-RJ45-DUAL (dual RJ45 sensor connector - pack of 10)	913703064409
DINGUS-UI-RJ45-DUAL (dual RJ45 DACM connector - pack of 10)	913703334609

\* Each sensor and DACM is supplied with a dual RJ45 connector.

## Component details



**PDRAS XXX** – for standalone deployments and offered in different voltages (120V, 277V, 347V\*)

**PD2DRAS XXX** – for dual room deployments and offered in different voltages (120V, 277V, 347V\*)

- Plenum rated enclosure
- Accepts UL924 trigger
- 20 Amp rating per switched output
- Powers multiple user interfaces and sensors, no separate power supply needed

Control 2 rooms and 2 dimming zones per room with the PD2DRAS

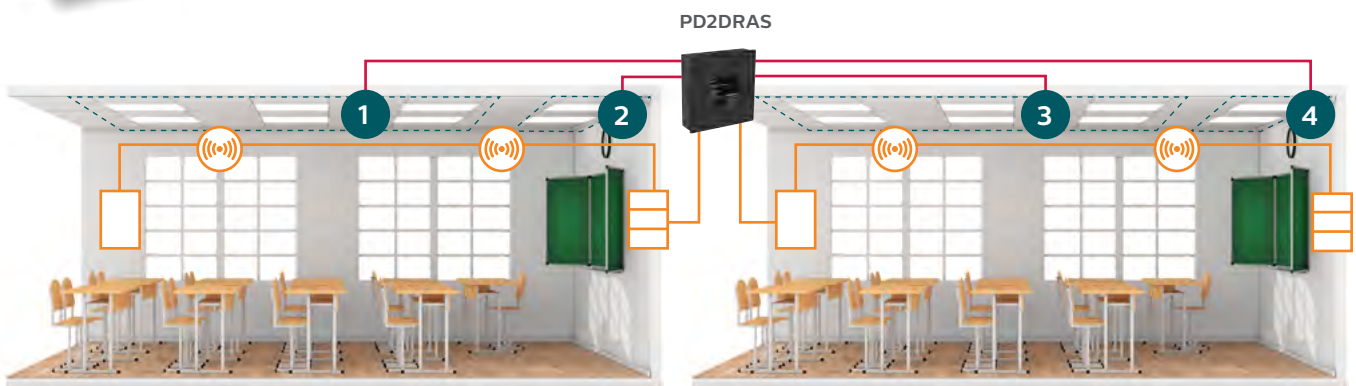

**DACM** – DyNet Communication Module for Antumbra user interfaces.

- Common communication module for single or dual room applications
- Adjust dip switch configuration for application fit and button type selection

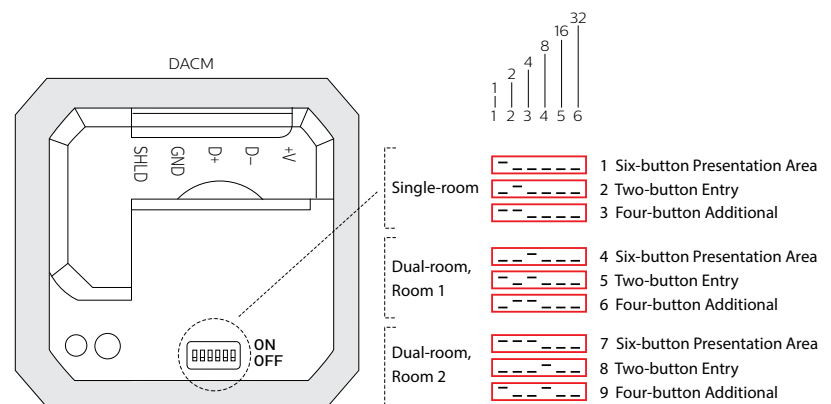

\* 347 VAC loads require external contactors, to be supplied by the installer.

# Need a networked system with monitoring and management capability?

The system is built upon Dynalite architecture and can be scaled up to a networked system using the PDRAS-E option where “E” represents Ethernet gateway and can connect multiple PDRAS boxes together to our head end System Manager software. From there you can monitor and manage rooms, as well as edit the channel levels within different lighting scenes, lux targets, sensor timeout, override, and schedules.



**PDRAS-E** – Includes a built in Ethernet gateway to network multiple spaces together. Specify one PDRAS-E box for every ten PDRAS or PD2DRAS controllers.

- Bridge functionality between Ethernet backbone and the DyNet fieldbus devices.
- Provides a web interface delivering access to the inbuilt timeclock and schedule editor functions.
- Employs HTTPS for secure, encrypted network communication.





© 2021 Signify Holding. All rights reserved. The information provided herein is subject to change, without notice. Signify does not give any representation or warranty as to the accuracy or completeness of the information included herein and shall not be liable for any action in reliance thereon. The information presented in this document is not intended as any commercial offer and does not form part of any quotation or contract, unless otherwise agreed by Signify.

PLt-21022BR 08/21 [dynamite.org](http://dynamite.org)

Signify North America Corporation  
200 Franklin Square Drive,  
Somerset, NJ 08873  
Telephone 855-486-2216

Signify Canada Ltd.  
281 Hillmount Road,  
Markham, ON, Canada L6C 2S3  
Telephone 800-668-9008

Philips and the Philips Shield Emblem are registered trademarks of Koninklijke Philips N.V. All other trademarks are owned by Signify Holding or their respective owners.