

# ASTROBOTIC LUNAR LANDERS

## *Payload User's Guide*

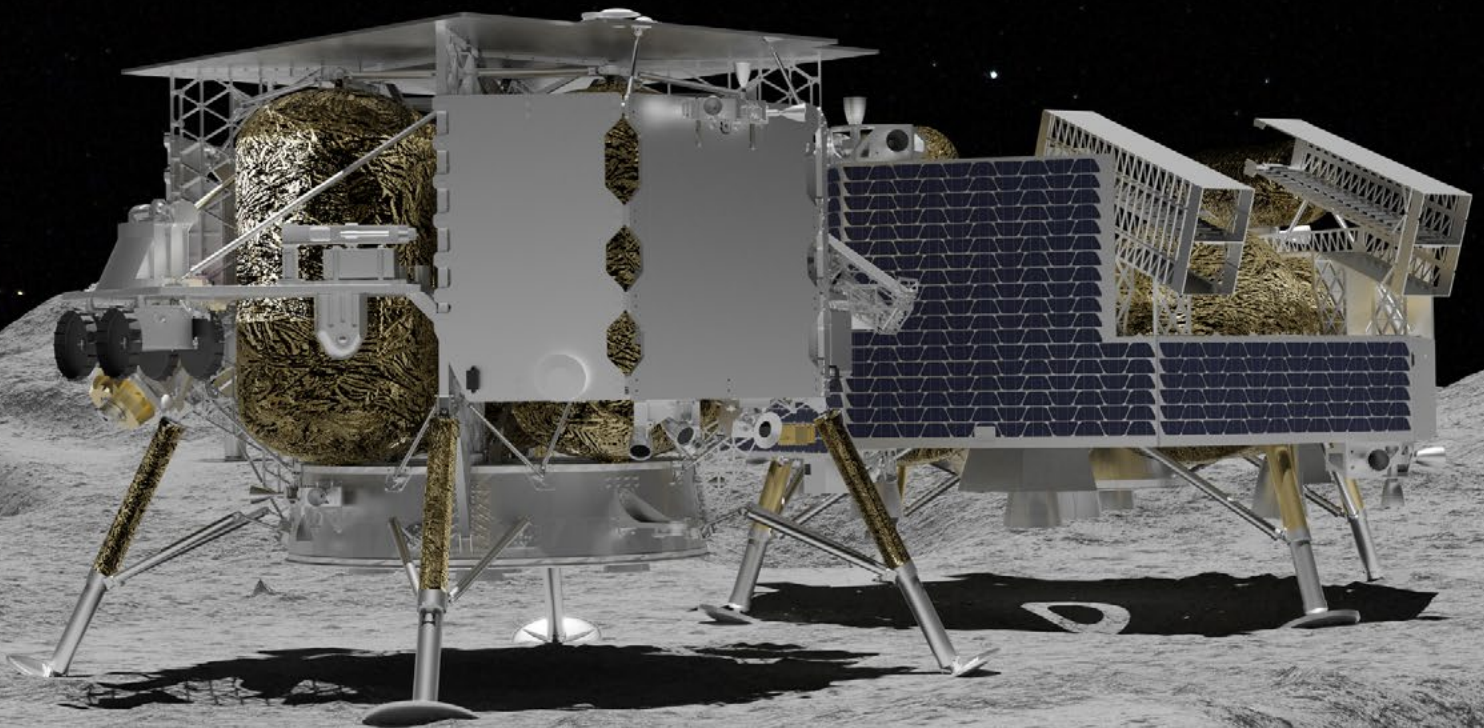

 **ASTROBOTIC**

Publicly available document, please contact  
Astrobotic Technology for more details.

August 2021 // Version 5.0

# TABLE OF CONTENTS

## **ABOUT US ..... 3**

What We Do.....	4
Service Overview.....	5
Payload Experience.....	6
Astrobotic Lunar Services.....	7
Lunar Orbit Delivery Locations.....	8
Lunar Surface Delivery Locations.....	9
Lunar Landers.....	10

## **PEREGRINE ..... 11**

Peregrine Lander.....	12
Structure.....	15
Propulsion.....	16
Guidance, Navigation, and Control.....	17
Power.....	18
Avionics.....	19
Communications.....	20
Thermal Control.....	21

## **GRIFFIN..... 22**

Griffin Lander.....	23
Structure.....	25
Propulsion.....	26
Guidance, Navigation, and Control.....	27
Power.....	28
Avionics.....	29
Communications.....	30
Thermal Control.....	31

## **ENVIRONMENTS ..... 32**

Mechanical Environment.....	33
Thermal Environment.....	35
Pressure and Humidity Environment.....	37
Contamination Control.....	38
Radiation Environment.....	39
Electromagnetic Environment.....	40

## **INTERFACES..... 41**

Payload Types.....	42
Payload Mounting Accommodations.....	43
Payload Mounting Decks.....	44
Adapter Plates.....	45

Electrical Interfaces.....	46
Release Mechanisms.....	47
Data Interfaces.....	48
Ground Segment.....	49

## **MISSION OPERATIONS..... 50**

Landing Site.....	51
Mission Profile.....	52
Trajectory.....	53
Descent Profile.....	54
Power Services.....	55
Data Services.....	56
Egress Procedures.....	57

## **PAYLOAD INTEGRATION ..... 59**

Mission Timeline.....	60
Integration.....	61

## **GLOSSARY..... 62**

Glossary of Units.....	63
Glossary of Terms.....	64
Glossary of Documentation.....	65
Glossary of Milestones.....	66

## **CONTACT US..... 66**

Questionnaire.....	67
--------------------	----



# **ABOUT ASTROBOTIC**

# WHAT WE DO



Astrobotic is a lunar logistics company providing end-to-end delivery services for payloads to the Moon.

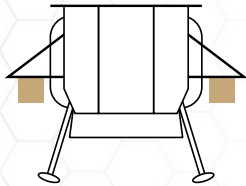

## PAYLOAD INTEGRATION

On each mission, Astrobotic works with payload customers to integrate their payloads onto a single Astrobotic lunar lander.

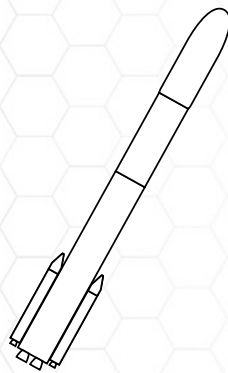

## LUNAR DELIVERY

Astrobotic's lander is launched on a commercially procured launch vehicle and safely delivers payloads to lunar orbit and the lunar surface.

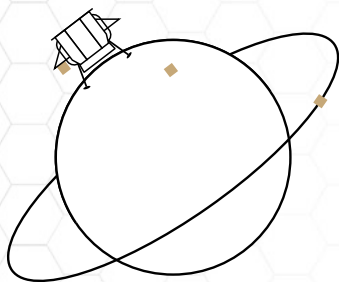

## PAYLOAD SERVICES

Astrobotic's lander provides power and data services to payloads during transit to the Moon and on the lunar surface.

Each payload customer receives comprehensive support from contract signature to end-of-mission. Astrobotic's Payload Customer Service Program equips the customer with the latest information on the mission and facilitates technical exchanges with Astrobotic payload managers and engineers to ensure payload compatibility with Astrobotic's lunar landers and overall mission success.

# SERVICE OVERVIEW



Companies, governments, universities, non-profits, and individuals can send payloads to the Moon at \$300K, \$1.2M, or \$4.5M per kilogram of payload delivered to lunar orbit, to the lunar surface, or on a rover, respectively.

Standard payload delivery options include lunar orbit and the lunar surface where payloads may remain attached to the lander, deploy from the lander for an independent mission, or hitch a ride on an Astrobotic lunar rover.

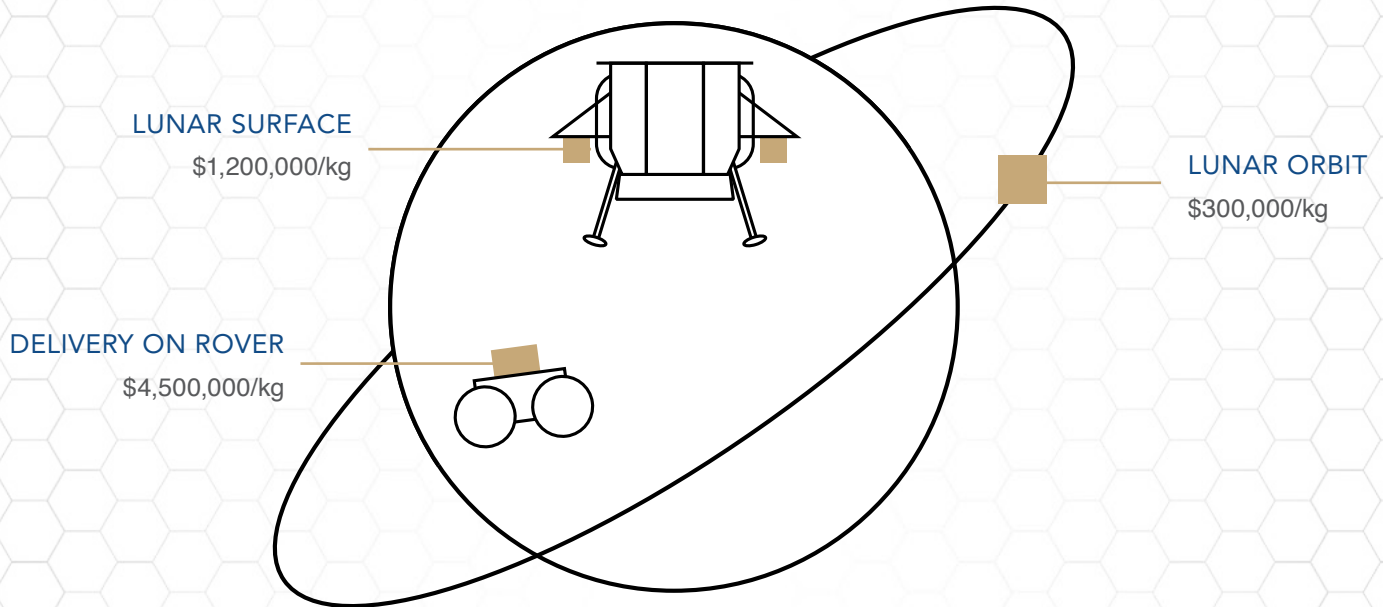

## FOR EVERY KILOGRAM OF PAYLOAD, ASTROBOTIC'S LANDER PROVIDES:



1.0 Watts  
**POWER**



10 kbps  
**BANDWIDTH**

Additional power and bandwidth are available for purchase upon request.

Please **contact Astrobotic** to learn more.



ASTROBOTIC  
**MOONBOX**  
Make your mark on history

Payloads less than 1 kg may be subject to integration fees. DHL MoonBox offers an affordable alternative to send small items to the Moon. Prices start at \$460.

**Check it out at [astrobotic.com](https://astrobotic.com).**



## DELIVERY ON A ROVER

The CubeRover is a modular vehicle designed to provide affordable mobility for scientific instruments and other payloads to operate on the surface of the Moon. Because CubeRover is so light — four kilograms — it dramatically reduces flight costs, making the Moon more accessible.

**Download the CubeRover PUG at [astrobotic.com](https://astrobotic.com)**

# PAYLOAD EXPERIENCE



1

## SERVICES AGREEMENT

Following contract signature, the payload customer is connected with their payload manager to begin development of a schedule and an Interface Control Document.

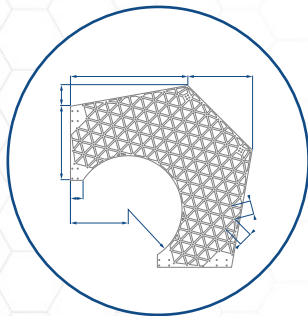

2

## TECHNICAL SUPPORT

Astrobotic supports the payload customer by hosting regular integration working group meetings, participating in payload design cycle reviews, and facilitating payload testing with simulated lander interfaces.



3

## INTEGRATION

The payload is sent to the Astrobotic integration facility. Astrobotic accepts the payload and integrates it onto the lander.



4

## MISSION

The integrated lander is launched and commences its mission. The Astrobotic Mission Control Center connects the customer to their payload during the flight to the Moon and on the lunar surface.

# ASTROBOTIC LUNAR SERVICES



Astrobotic is here to support the success of your payload mission. The standard payload interfaces and services are defined to enable nominal payload missions. This Payload User's Guide (PUG) provides an overview of these standard interfaces and services.

Astrobotic can accommodate payloads with needs outside of the standard interfaces and services at additional cost. Please contact Astrobotic to discuss any nonstandard requests such as custom interfaces, accommodation of large or unusual geometries, specific trajectory or landing site requirements, payload design consulting services, etc.

The Payload Customer Service Program is a standard service for all payload customers to provide the tools necessary to design a payload that successfully interfaces with Astrobotic landers.

*The following features are included as part of the program:*

## PAYLOAD CUSTOMER SERVICE PROGRAM

- 1 Availability for general and technical inquiries.
- 2 Bi-weekly technical exchanges with Astrobotic mission engineers.
- 3 Access to the Astrobotic library of payload design resources and standards.
- 4 Technical feedback through payload milestone design reviews.
- 5 Facilitation of lander-payload interface compatibility testing.

*Access to materials within the Astrobotic library is not always restricted to signed customers. Please contact Astrobotic for more information on obtaining the latest version of any document referenced within this PUG.*

# LUNAR ORBIT DELIVERY LOCATIONS



Astrobotic's landers can deliver payloads to lunar orbit as well as the lunar surface. While the trajectory can change from mission to mission, Peregrine and Griffin typically hold in three distinct Lunar Orbits (LO's), and two are available for payload deployment. The periapsis is consistent at 100 km while the apoapsis decreases through Lunar Orbit Insertion (LOI) maneuvers from 8700 km to a circular 100 km. The orbital inclination is typically determined by the surface landing site.

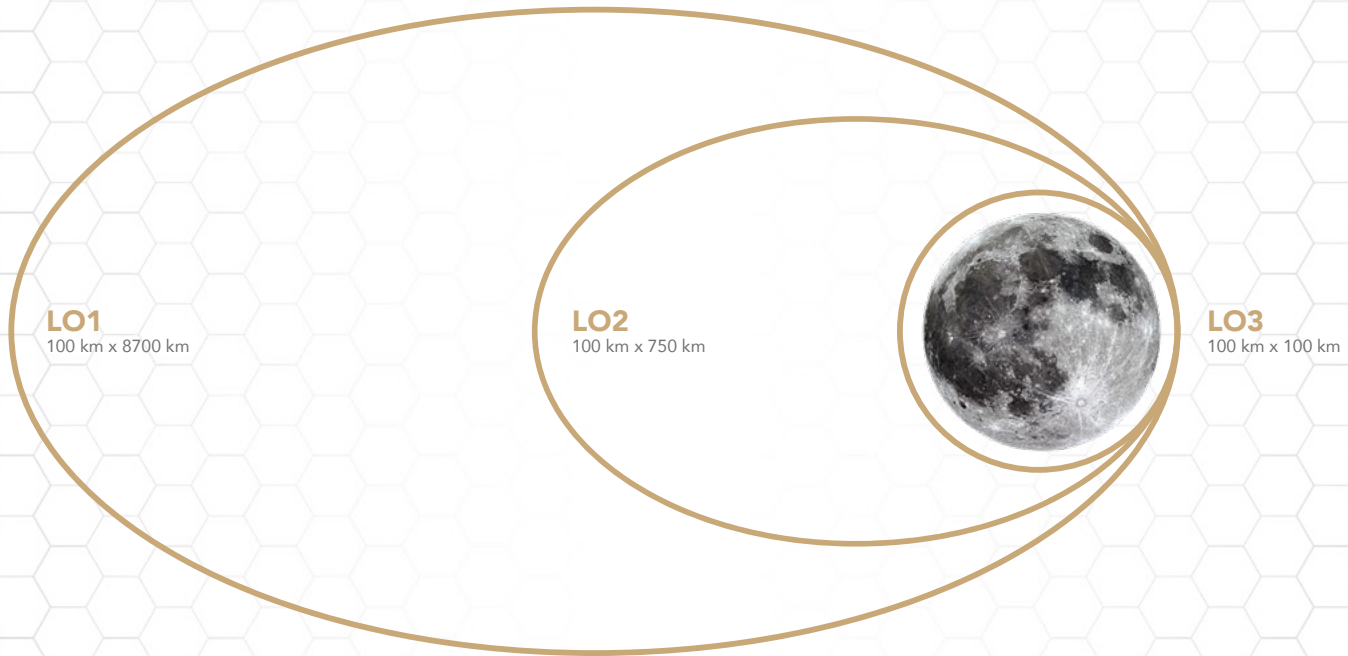

## LUNAR ORBIT 1 (LO1)

The initial lunar orbit, LO1 is a highly elliptical orbit. Peregrine and Griffin nominally spend 12 hours in LO1. Nonstandard payload deployment may be available in this orbit upon request.

## LUNAR ORBIT 2 (LO2)

The next lunar orbit, LO2 is a stable elliptical orbit. The time Peregrine and Griffin spend in LO2 depends on the launch date and subsequent trajectory as well as the orbital deployment schedule. All payload deployments are nominally planned for this orbit.

## LUNAR ORBIT 3 (LO3)

The final lunar orbit, LO3 is a circular orbit. Peregrine and Griffin nominally spend 72 hours in LO3 for descent preparations. Payload deployment is not supported in this orbit.



# LUNAR SURFACE DELIVERY LOCATIONS



Astrobotic's landers are capable of supporting payload missions to locations of interest from the lunar equator to the poles. For example, Peregrine Mission One (PM1) will deliver payloads to a landing site near Lacus Mortis, (44°N, 25°E) and Griffin Mission One (GM1) will deliver payloads to a landing site near the South Pole.

Astrobotic's landers incorporate technology such as Astrobotic's Optical Precision Autonomous Landing (OPAL) Sensor, a terrain relative navigation system for precision landing. These systems enable polar landings and other missions requiring precision landing capabilities.

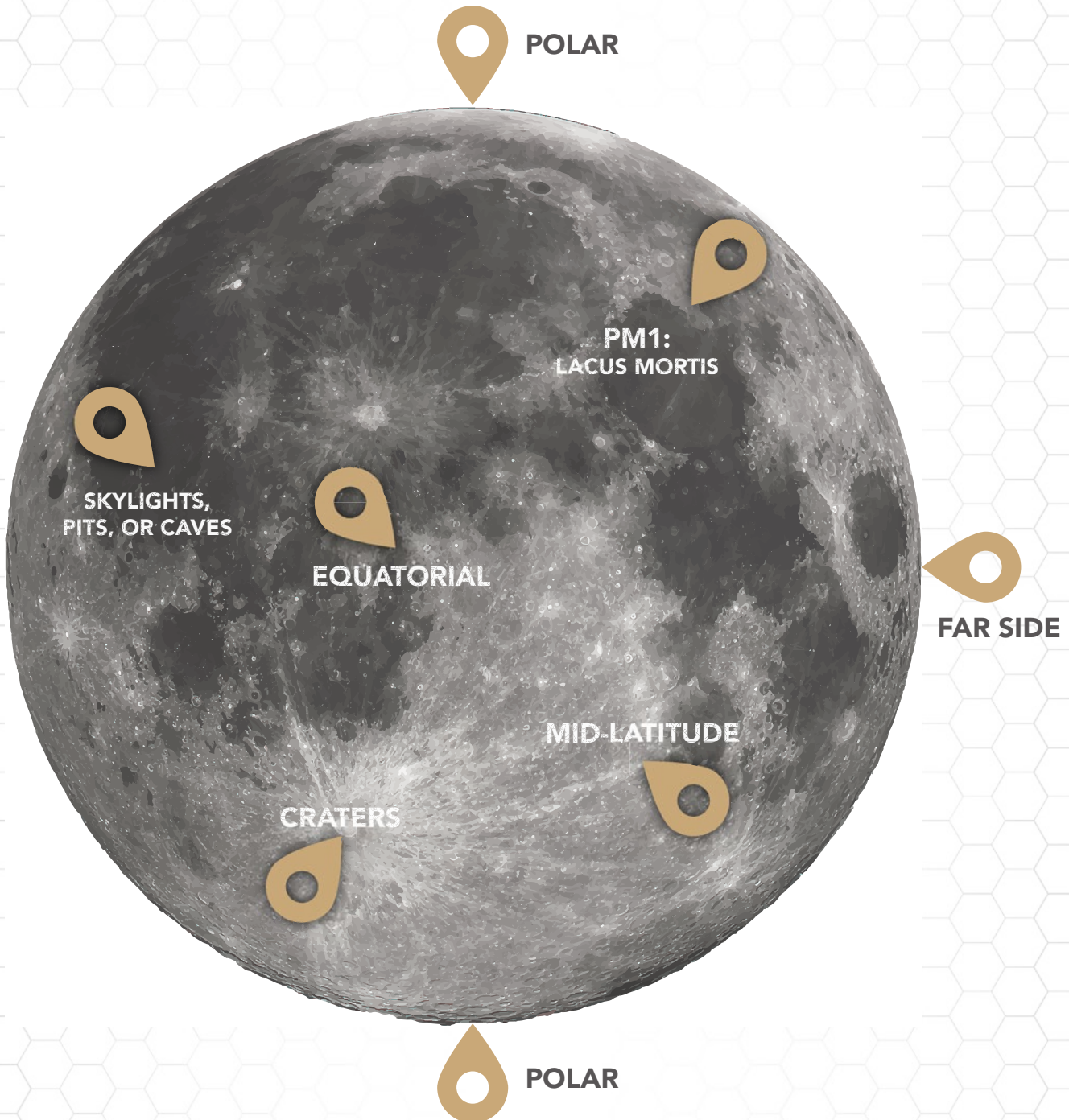

# LUNAR LANDERS



## PEREGRINE:

Peregrine is a small-class lander that precisely and safely delivers payloads to lunar orbit and the lunar surface. Payloads can be mounted above or below the decks, inside or outside of enclosures, and can remain attached or deployed according to their needs.

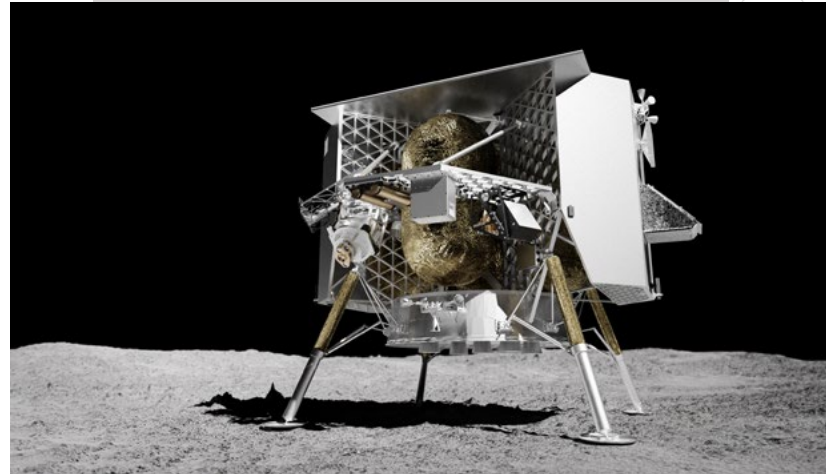

## GRIFFIN:

Griffin is a medium-class lander with flexible mounting options to accommodate a variety of rovers and other large payloads. Its autonomous sensor systems provide a safe and precise landing in even rugged and hazardous terrain, enabling it to support robotic missions such as resource prospecting, polar volatile characterization, and skylight exploration.

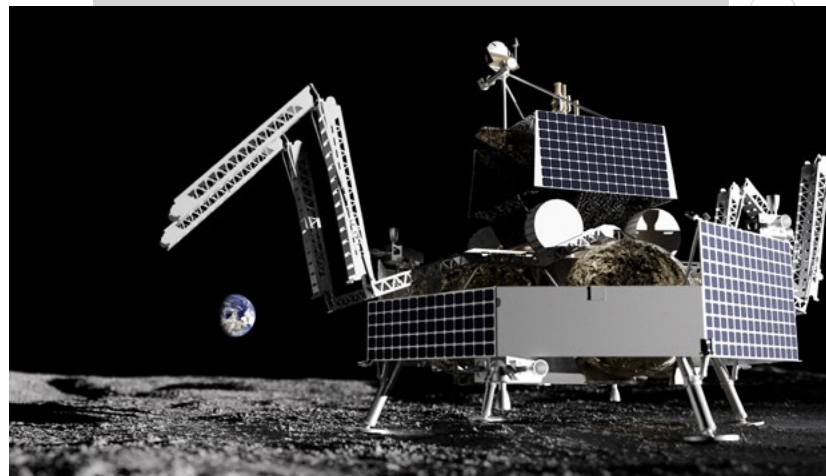

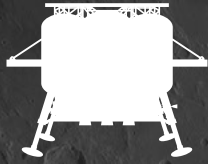

# PEREGRINE

# PEREGRINE LANDER

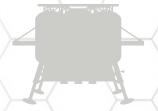

Astrobotic has designed a core set of systems, known as the bus, that are common across our Peregrine and Griffin landers. The lander bus design enables safe payload delivery to lunar orbit and any latitude on the lunar surface. The bus can be arranged, augmented, and adapted to the various payload delivery locations. We have applied this common bus to our Peregrine lander. A configuration that accommodates a variety of payload types for science, exploration, marketing, resources, and commemoration. Other alterations to the lander bus, such as additional sensors for precision landing or a satellite communications relay for far-side operations, may be necessary depending on the specific mission.

The Peregrine Lander is comprised of the following systems.

- 1 STRUCTURES**  
Provides mounting locations for payloads and lander systems.
- 2 PROPULSION**  
Maneuvers lander after separation from the launch vehicle.
- 3 GUIDANCE, NAVIGATION, AND CONTROL**  
Controls, orients, and flies the lander throughout the mission.
- 4 POWER**  
Generates, stores, and distributes power to payloads and lander systems.
- 5 AVIONICS**  
Performs all command and data handling for the lander.
- 6 COMMUNICATIONS**  
Provides communication services between ground stations and the lander.
- 7 THERMAL CONTROL**  
Regulates and controls thermal interfaces for lander systems.

The following pages highlight the mid-latitude and polar configurations of Peregrine and explore each system in more detail. Additional configurations for lunar orbit, equatorial, far side, and many more delivery locations are possible. Contact Astrobotic for more details on specific configurations.

# MID-LATITUDE CONFIGURATION

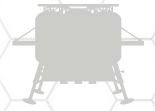

Peregrine's mid-latitude configuration is designed to land and operate at latitudes between 40° and 50° North or South. The lander features side radiators and a top mounted solar panel. This configuration will be flown on Astrobotic's Mission One as a co-manifested payload aboard ULA's Vulcan Centaur launch vehicle.



MID-LATITUDE	
<b>Lunar Surface Payload Delivery Capacity</b>	70-90 kg
<b>Surface Operations Duration</b>	192 hours

# POLAR CONFIGURATION



Missions to the polar regions of the lunar surface feature side-mounted solar panels to produce sufficient power at higher latitudes and support payload needs. Lander avionics are mounted to a radiator at the top of the lander.

Medium Gain Antenna

Radiator Sun Shield

Stretched Propellant Tanks

Payload Mounting Decks

High Gain Antenna

Attitude Control Thrusters

Side-Mounted Solar Panels

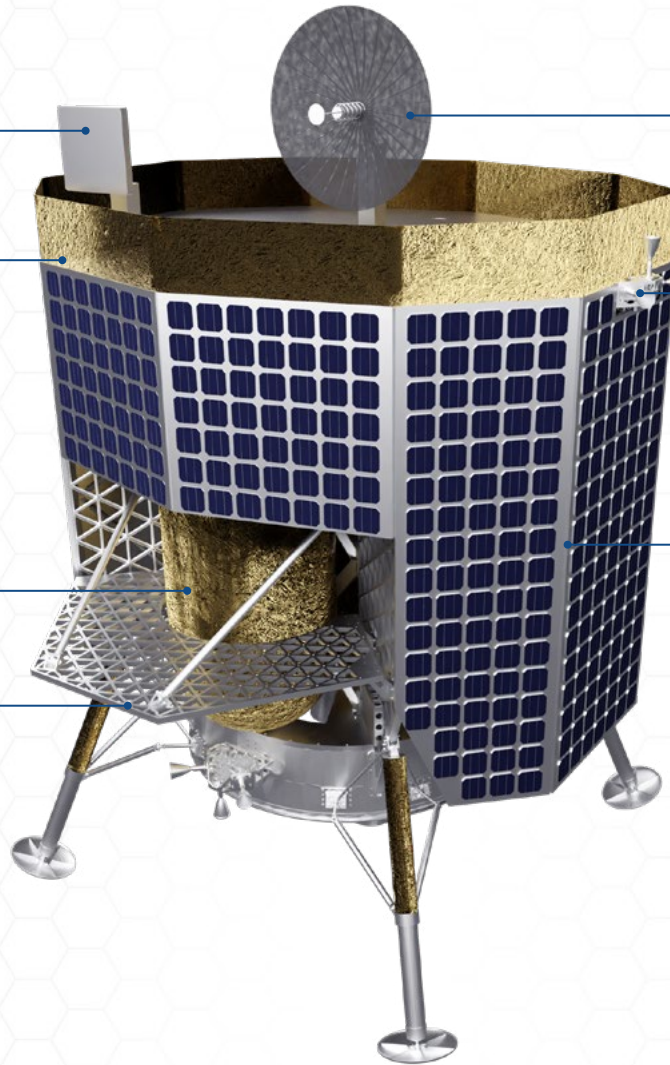

## POLAR

**Lunar Surface Payload Delivery Capacity**

100 kg

**Surface Operations Duration**

192+ hours

NOTE: Some polar landing sites have periods of continuous sunlight that last longer than a lunar day at mid-latitude.

# STRUCTURE



Peregrine's structure is strong, stiff, and lightweight for survivability during launch and landing. The bus structure is manufactured out of aluminum alloy and is comprised of three primary components, the launch vehicle adapter cone, isogrid shear panels, and two aluminum honeycomb enclosures. The standard physical mounting interface for the payloads is optimized for the specific mission profile. For missions to the lunar surface, four landing legs, designed to absorb shock and stabilize the craft on touchdown, are fastened to the bus structure.

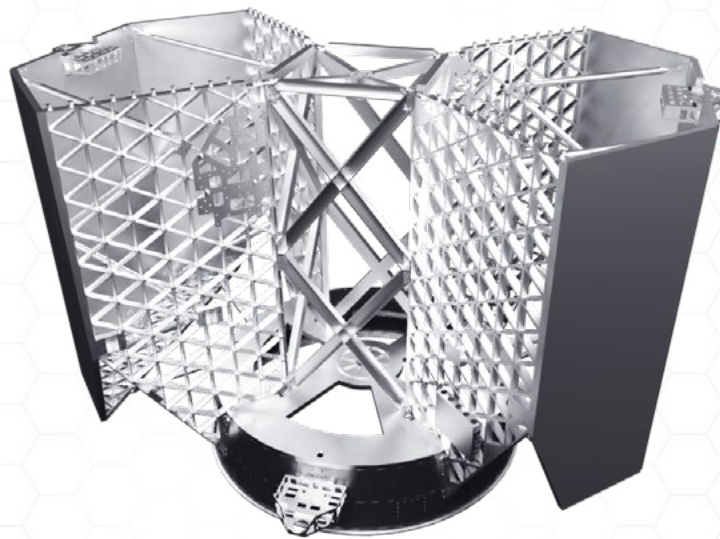

Peregrine Structural Bus

## LAUNCH VEHICLE ADAPTER CONE

The launch vehicle adapter cone houses the main engines. Additionally, it serves as the adapter to the launch vehicle where a releasable clamp band mates Peregrine to the launch vehicle and enables separation.

## ISOGRID SHEAR PANELS

The aluminum isogrid shear panels support the secondary elements of the lander such as fuel tanks, payload mounting decks, and the solar panel. An internal truss structure ties the four shear panels together and serves as a central column for the structure.

## ENCLOSURES

The aluminum honeycomb enclosures provide mounting surfaces and protection for lander avionics. In some configurations these enclosures are also the primary radiators for the lander's thermal system. In other configurations they are converted to mounting surfaces for solar panels.

# PROPULSION



The Peregrine propulsion system features five main engines and twelve Attitude and Control System (ACS) engines powered by a pressure-fed hypergolic bipropellant, which does not require ignition because the fuel and oxidizer combust on contact. The system features a proven hydrazine derivative, Mono-Methyl-Hydrazine (MMH), as the fuel. The oxidizer is a solution of nitric oxide in dinitrogen tetroxide/nitrogen dioxide, 25% Mixed Oxides of Nitrogen (MON-25).

Two tanks each of the fuel and oxidizer are spaced evenly about the craft with a fifth tank for the Helium pressurant in the center. Peregrine's main engines, located within the cone, are used for all major maneuvers. Each of the engines produces 667 N of thrust and is pulsed for throttling. The ACS thrusters, grouped in clusters of three and placed about the lander to ensure control with six degrees of freedom, maintain lander orientation throughout the mission. The ACS engines each generate 45 N of thrust.

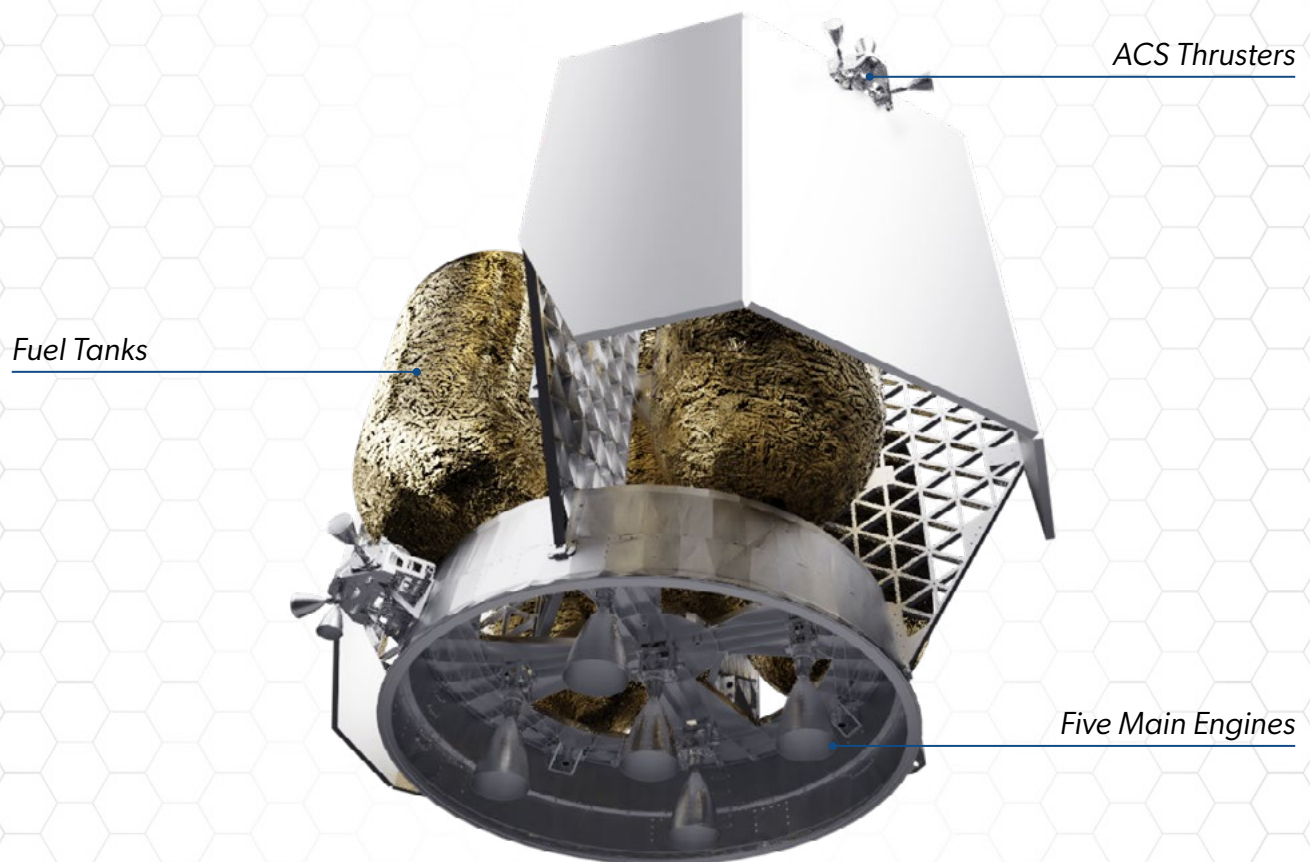

Peregrine Propulsion Bus



# GUIDANCE, NAVIGATION, AND CONTROL



Peregrine's Guidance, Navigation, and Control (GNC) system orients and flies the lander throughout the mission to facilitate operations. GNC processes the inputs from an array of sensors, correcting for idiosyncrasies, and uses them to revise the internal estimate of the lander's position, attitude, and velocity during flight. Commands to maneuver the lander are updated based on this estimate of the spacecraft's state. Earth-based ranging informs position and velocity state estimates for orbital and trajectory correction maneuvers.

Input from the star tracker, sun sensors, and inertial measurement unit aid the GNC system in maintaining a sun-pointing orientation, with the solar panel facing the Sun, during nominal cruise operations. During landing operations, a Doppler LiDAR provides range and range rate information that guides the lander to a safe landing at the target site.



OPAL Sensor Assembly

## OPTICAL PRECISION AUTONOMOUS LANDING SENSOR

Astrobotic leads a team comprised of Moog Space and Defense, Moog Broad Reach, NASA Jet Propulsion Laboratory (JPL), and NASA Johnson Space Center (JSC) developing the Optical Precision Autonomous Landing (OPAL) Sensor. The OPAL Sensor is an imaging-based terrain relative navigation package that will be flown as a technology demonstration on Mission One and then incorporated with the GNC system on the following missions. The OPAL Sensor consists of a camera and high performance computer, which uses images from the camera and maps stored in the lander memory to estimate the pose of the lander in real time.

# POWER



The lander power system is responsible for power storage, generation, distribution, and management. The system is designed to be power positive, generating more power than it uses, for all phases of flight except for descent to the lunar surface where the lander relies on battery power for a short period.

Peregrine stores energy in a space-grade lithium-ion battery. A panel of GaInP/GaAs/Ge triple junction solar cells with heritage in orbital and deep space missions generates the lander's power. The battery feeds into a 28 Vdc power rail from which unregulated and regulated power is distributed to all lander subsystems and payloads. The battery is utilized during quick discharge activities, such as engine burns and attitude maneuvers, and during phases of the mission where the solar panel is not generating power, such as in lunar shadow.

While in orbit, the solar panel is nominally pointed towards the Sun to enable maximum power generation. The solar panel is utilized to provide battery charge and maintain lander and payload operations. After descent to the lunar surface the power system continues to provide reliable power services to payloads through the end of mission.



Peregrine Mid-Latitude Solar Panel Configuration

## SOLAR PANEL CONFIGURATIONS

Missions to different latitudes on the lunar surface require that the solar panels used on Peregrine be reconfigured to optimize power generation. Mid-latitude and equatorial landers utilize top-mounted panels whereas polar missions utilize side-mounted panels. Landers with side-mounted panels perform a thermal control roll during transit to ensure consistent power generation.

# AVIONICS



Peregrine's avionics perform all command and data handling for the lander, managing the various inputs and outputs of the lander's subsystems. The Integrated Avionics Unit (IAU) houses ten modules, or boards, with distinct functionalities encompassing the major aspects of the avionics system like the power management systems and the flight computer.

Other aspects, such as GNC flight sensor drivers and propulsion control units, are enclosed separately near the relevant subsystem hardware. Peregrine's flight computer consists of a 32-bit high-performance dual-core LEON 3 FT microprocessor. The computer employs radiation hardened integrated circuits as well as fault-tolerant and SEU-proof characteristics.

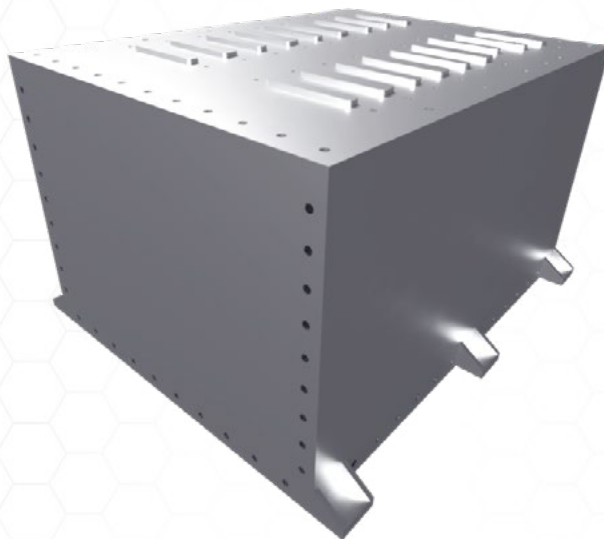

Integrated Avionics Unit (IAU) Enclosure

## THE PAYLOAD COMPUTER

The payload computer, a pair of radiation-tolerant FPGAs, is also housed within the IAU and manages the individual payloads as well as their contractual services. The payload computer monitors payload power consumption and communicates directly with the payloads. Commands from the payload ground software are sent to the payload via the payload computer and payload telemetry is packaged for downlink to Earth. The payload computer features Error Detection And Correction, upset monitoring, and robust software with proven networking standards.

## FLIGHT HERITAGE

Peregrine's avionics system is designed to be modular and reusable; this enables future Peregrine missions to leverage the lessons learned and hardware developed for Mission One. While missions will utilize different lander configurations, the core command and data handling system remains the same, maintaining reliability for the product line.

# COMMUNICATIONS

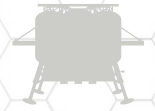

Peregrine's communications system provides for lander commanding and telemetry. The communications system also relays data between the payload customer and their payload throughout the mission. The lander houses a high-powered and flight-heritage transponder to communicate with Earth. The lander-Earth connection uses different frequencies within the X-Band range for uplink and downlink space communications.

The lander utilizes multiple low gain antennas for optimal coverage during cruise and lunar orbit operations and then switches to an actuated medium or high gain antenna following touchdown on the lunar surface for increased bandwidth. The lander-payload connection is provided via Serial RS-422 or SpaceWire for wired communication throughout the mission. Following landing, a 2.4 GHz IEEE 802.11n compliant WLAN modem enables wireless communication between the lander and deployed payloads on the lunar surface. Peregrine relays payload telecommands and telemetry in near real-time.

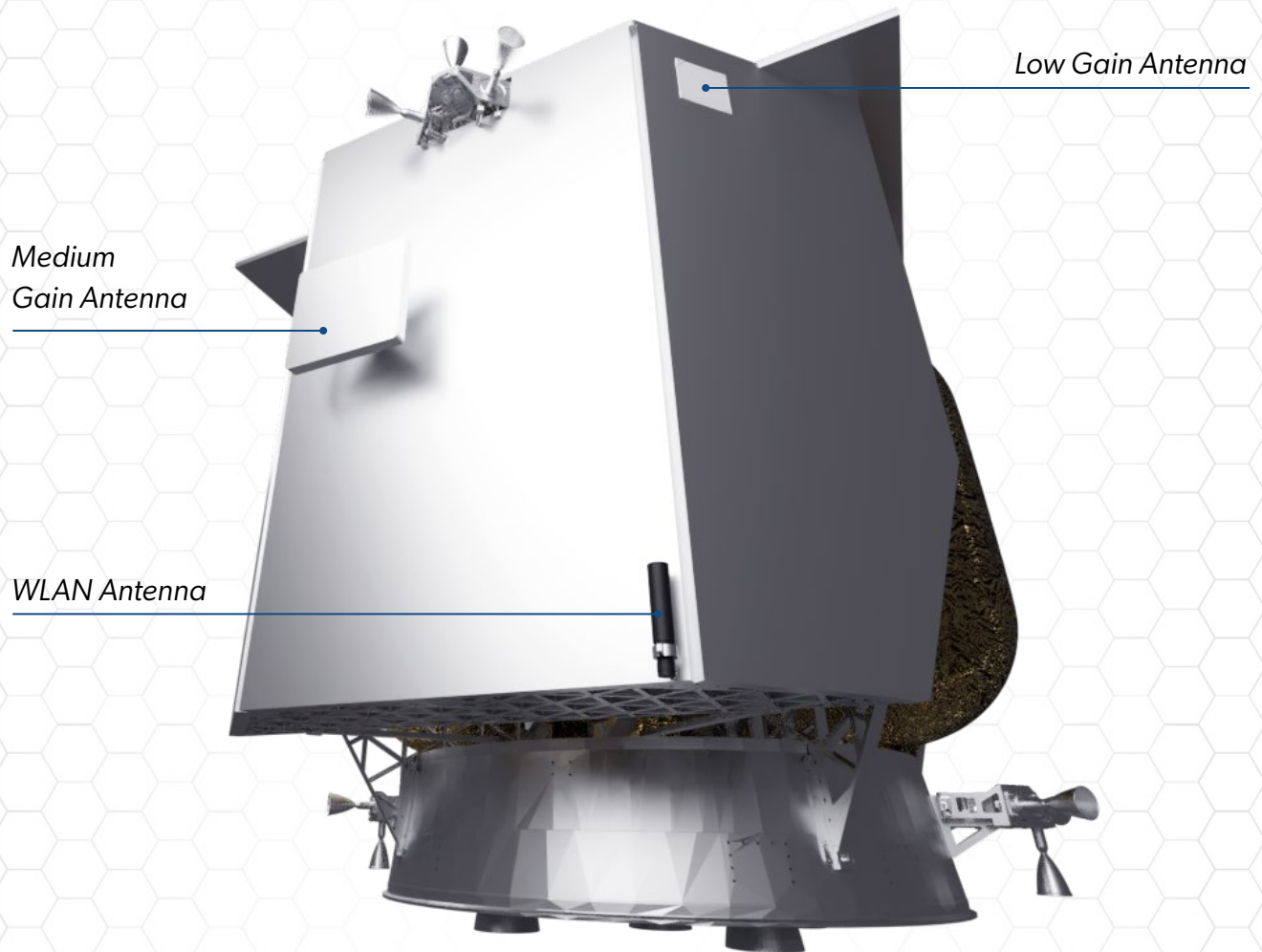

Peregrine Communications Bus

# THERMAL CONTROL

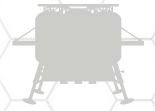

The lander is designed to implement mainly passive methods to regulate its thermal environment. Radiators are used to amass excess heat and radiate it out into space. Passive heat pipes are employed to direct excess heat to colder regions of the lander where it is needed. Layers and coatings, such as Multi-Layer Insulation (MLI), are used to protect components from undesired external thermal effects.

Some active thermal control methods, heating or cooling, may be implemented to maintain particularly stringent thermal conditions of sensitive critical components. The overall thermal design is highly mission-specific as the lander may be either hot or cold-biased depending on the extreme thermal case of each mission profile.



Peregrine Thermal Bus



# GRIFFIN

# GRIFFIN LANDER



Griffin also utilizes the Astrobotic common spacecraft bus, which acts as the base for every Griffin configuration. Similar to Peregrine, the Griffin lander is arranged, augmented, and adapted to the various payload delivery locations, however Griffin is sized to accommodate a larger class of payload. This flexibility allows Griffin to accommodate a variety of payload types for science, exploration, marketing, resources, and commemoration. In order to do this Griffin utilizes upgraded communication systems, structures, propulsion systems, and thermal control solutions to ensure the lander meets the most demanding of payload requirements. Other alterations to the lander, such as rovers, egress ramps, or additional sensors for precision landing, a satellite communications relay for far-side operations, may be necessary depending on the specific mission.

The Griffin Lander is comprised of the following systems.

- 1 STRUCTURES**  
Provides mounting locations for payloads and lander systems.
- 2 PROPULSION**  
Maneuvers lander after separation from the launch vehicle.
- 3 GUIDANCE, NAVIGATION, AND CONTROL**  
Controls, orients, and flies the lander throughout the mission.
- 4 POWER**  
Generates, stores, and distributes power to payloads and lander systems.
- 5 AVIONICS**  
Performs all command and data handling for the lander.
- 6 COMMUNICATIONS**  
Provides communication services between ground stations and the lander.
- 7 THERMAL CONTROL**  
Regulates and controls thermal interfaces for lander systems.

The following pages highlight the polar configuration of the Griffin bus as utilized on Griffin Mission One to deliver the NASA VIPER rover to the lunar South Pole. Additional configurations for lunar orbit, equatorial, far side, and many more delivery locations are possible. Contact Astrobotic for more details on specific configurations.

# POLAR CONFIGURATION



Missions to the polar regions of the lunar surface feature side-mounted solar panels to produce sufficient power at higher latitudes and support payload needs. Lander avionics are mounted on the underside of radiators that form the decks of the lander. The lander also features side radiators that provide additional thermal control capabilities.

Griffin's side-mounted solar panels produce sufficient power at higher latitudes and support payload needs. This configuration will be flown on Astrobotic's Griffin Mission One with NASA's VIPER rover as a payload aboard SpaceX's Falcon Heavy launch vehicle.



POLAR	
<b>Lunar Surface Payload Delivery Capacity</b>	625 kg
<b>Surface Operations Duration</b>	Up to 14 Days

NOTE: Some polar landing sites have periods of continuous sunlight that last longer than a lunar day at mid-latitude.



# STRUCTURE



Griffin's structure is strong, stiff, and lightweight for survivability during launch and landing. The bus structure is manufactured out of aluminum alloy and is comprised of three primary components, the launch vehicle adapter cone, solid deck panels, and four radiator panels for directly mounting payloads or avionics. The standard physical mounting interface for the payloads is optimized for the specific mission profile. In the figure below, the upper cone was specifically designed to accommodate the NASA VIPER rover. For missions to the lunar surface, four landing legs, designed to absorb shock and stabilize the craft on touchdown, are fastened to the bus structure.

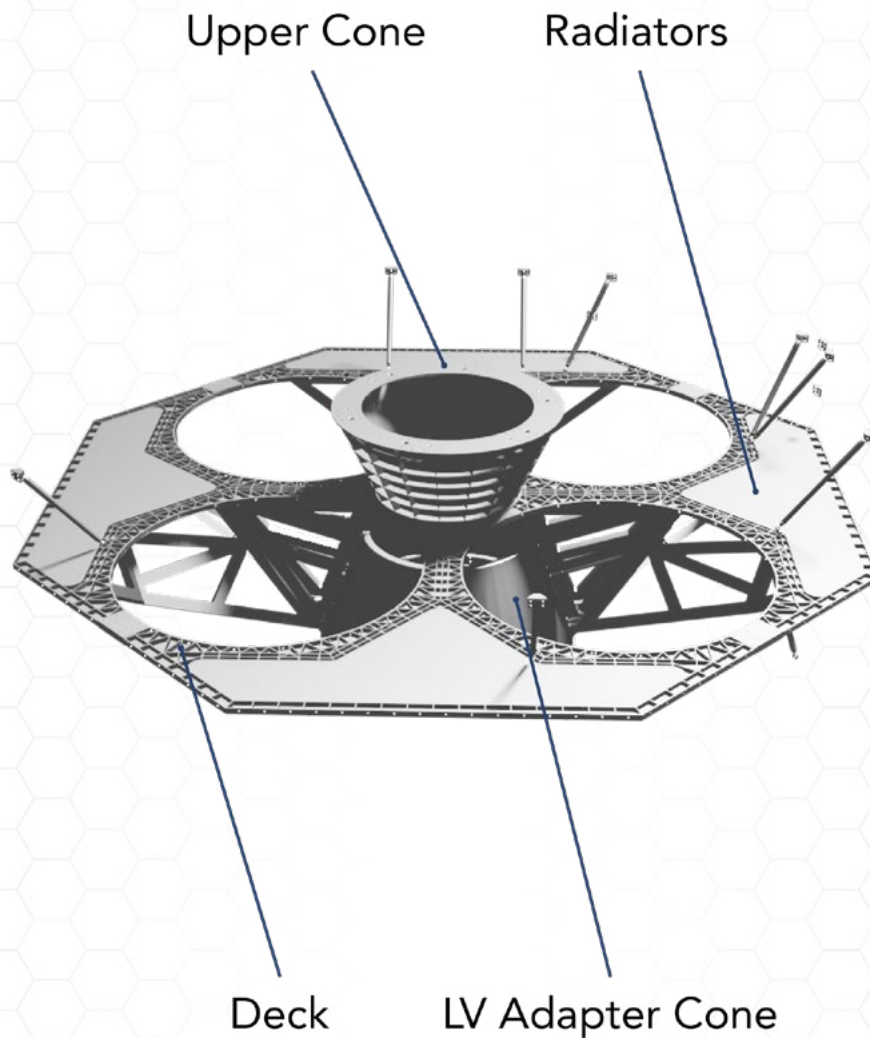

## LAUNCH VEHICLE ADAPTER CONE

The launch vehicle adapter cone serves as the connection to the launch vehicle where a releasable clamp band mates Griffin and enables separation.

# PROPULSION



The Griffin propulsion system features five 700 lbf pulsed main engines and twelve 25 lbf Attitude Control System (ACS) engines powered by a pressure-fed hypergolic bipropellant, which does not require ignition because the fuel and oxidizer combust on contact. The system features a proven hydrazine derivative, M20 as the fuel, and a MON3 Oxidizer. This combination offers enhanced performance for missions requiring the maximum amount of Delta-V

Two tanks each of the fuel and oxidizer are spaced evenly about the craft. Griffin's main engines, located within the cone, are used for all major maneuvers. Each of the engines is pulsed for throttling similar to the engines on Peregrine. The ACS thrusters, grouped in clusters of three and placed about the lander to ensure control with six degrees of freedom, maintain lander orientation throughout the mission.

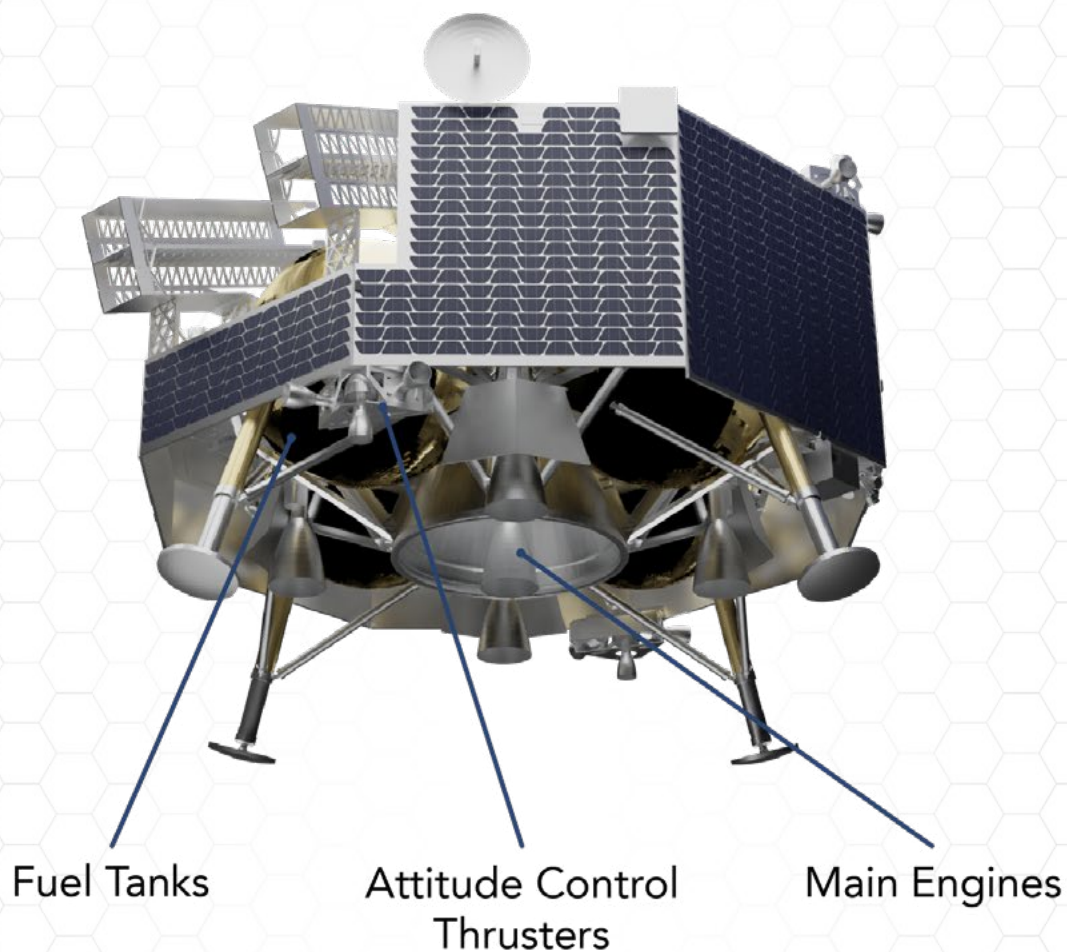

# GUIDANCE, NAVIGATION, AND CONTROL



Griffin uses the same overall Guidance, Navigation, and Control (GNC) architecture that Astrobotic will fly for Peregrine Mission One as the system orients and flies the lander throughout each mission to facilitate operations. GNC processes the inputs from an array of sensors, correcting for idiosyncrasies, and uses them to revise the internal estimate of the lander's position, attitude, and velocity during flight. Commands to maneuver the lander are updated based on this estimate of the spacecraft's state. Earth-based ranging informs position and velocity state estimates for orbital and trajectory correction maneuvers.

Input from the star tracker, sun sensors, and inertial measurement unit aid the GNC system in maintaining a sun-pointing orientation, with the side-mounted solar panels facing the Sun, during nominal cruise operations. During landing operations, a Doppler LiDAR provides range and range rate information that guides the lander to a safe landing at the target site.



OPAL Sensor Assembly

## OPTICAL PRECISION AUTONOMOUS LANDING SENSOR

Astrobotic leads a team comprised of Moog Space and Defense, Moog Broad Reach, NASA Jet Propulsion Laboratory (JPL), and NASA Johnson Space Center (JSC) developing the Optical Precision Autonomous Landing (OPAL) Sensor. The OPAL Sensor is an imaging-based terrain relative navigation package that will be flown as a technology demonstration on Peregrine Mission One and will be incorporated with the GNC system on Griffin Mission One. The OPAL Sensor consists of a camera and high-performance computer, which uses images from the camera and maps stored in the lander memory to estimate the pose of the lander in real time.

# POWER



The lander power system is responsible for power storage, generation, distribution, and management. The system is designed to be power positive, generating more power than it uses, for all phases of flight except for descent to the lunar surface where the lander relies on battery power for a short period.

Griffin stores energy in a space-grade lithium-ion battery. A panel of GaInP/GaAs/Ge triple junction solar cells with heritage in orbital and deep space missions generates the lander's power. Griffin utilizes the same battery and solar cells as Peregrine, however Griffin can be configured to carry larger solar arrays and additional batteries to maximize power capabilities during transit and on the lunar surface. The battery feeds into a 28 Vdc power rail from which unregulated and regulated power is distributed to all lander subsystems and payloads. The battery is utilized during quick discharge activities, such as engine burns and attitude maneuvers, and during phases of the mission where the solar panel is not generating power, such as in lunar shadow.

While in orbit, Griffin's fixed solar panels are nominally pointed towards the Sun to enable maximum power generation. The solar panel is utilized to provide battery charge and maintain lander and payload operations. After descent to the lunar surface the power system continues to provide reliable power services to payloads through the end of mission.

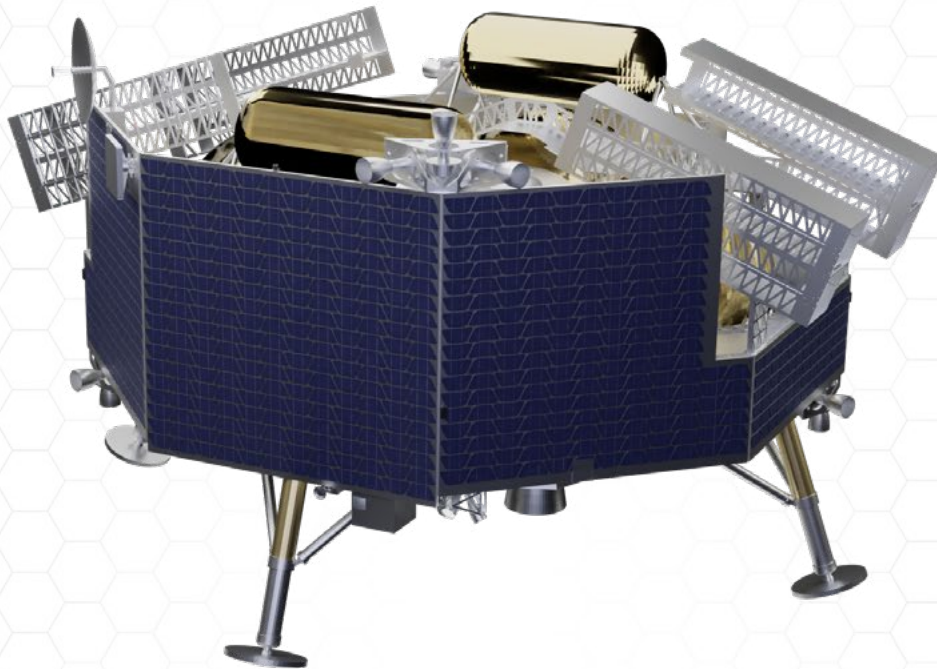

## SOLAR PANEL CONFIGURATIONS

Missions to different latitudes on the lunar surface require that the solar panels used on Griffin be reconfigured to optimize power generation. Mid-latitude and equatorial landers utilize top-mounted panels whereas polar missions utilize side-mounted panels. Landers with side-mounted panels perform a thermal control roll during transit to ensure consistent power generation. Griffin is also capable of carrying deployable solar panels which can greatly expand its potential power generation.



Griffin's avionics are part of the same common spacecraft core utilized by Peregrine, which perform all command and data handling for the lander, managing the various inputs and outputs of the lander's subsystems. The Integrated Avionics Unit (IAU) houses ten modules, or boards, with distinct functionalities encompassing the major aspects of the avionics system like the power management systems and the flight computer.

Other aspects, such as GNC flight sensor drivers and propulsion control units, are enclosed separately near the relevant subsystem hardware. Griffin's flight computer consists of a 32-bit high-performance dual-core LEON 3 FT microprocessor. The computer employs radiation hardened integrated circuits as well as fault-tolerant and SEU-proof characteristics.

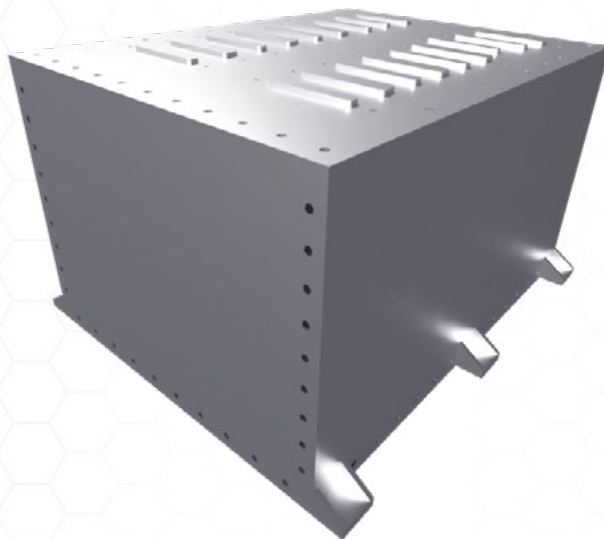

Integrated Avionics Unit (IAU) Enclosure

## THE PAYLOAD COMPUTER

The payload computer, a pair of radiation-tolerant FPGAs, is also housed within the IAU and manages the individual payloads as well as their contractual services. The payload computer monitors payload power consumption and communicates directly with the payloads. Commands from the payload ground software are sent to the payload via the payload computer and payload telemetry is packaged for downlink to Earth. The payload computer features Error Detection And Correction, upset monitoring, and robust software with proven networking standards.

## FLIGHT HERITAGE

The Griffin avionics system is designed to be modular and reusable; this enables future Griffin missions to leverage the lessons learned and hardware developed for Mission One. While missions will utilize different lander configurations, the core command and data handling system remains the same, maintaining reliability for the product line.

# COMMUNICATIONS



Griffin's communications system provides for lander commanding and telemetry. This system can be configured to the same specifications as Peregrine or can be upgraded to enhance data services between the lander and Earth. The communications system relays data between the payload customer and their payload throughout the mission. The lander houses a high-powered and flight-heritage transponder to communicate with Earth. The lander-Earth connection uses different frequencies within the X-Band range for uplink and downlink space communications.

The lander utilizes multiple low gain antennas for optimal coverage during cruise and lunar orbit operations and then switches to an actuated medium or high gain antenna following touchdown on the lunar surface for increased bandwidth. The lander-payload connection is provided via Serial RS-422 or SpaceWire for wired communication throughout the mission. Following landing, a 2.4 GHz IEEE 802.11n compliant WLAN modem enables wireless communication between the lander and deployed payloads on the lunar surface. Griffin relays payload telecommands and telemetry in near real-time.

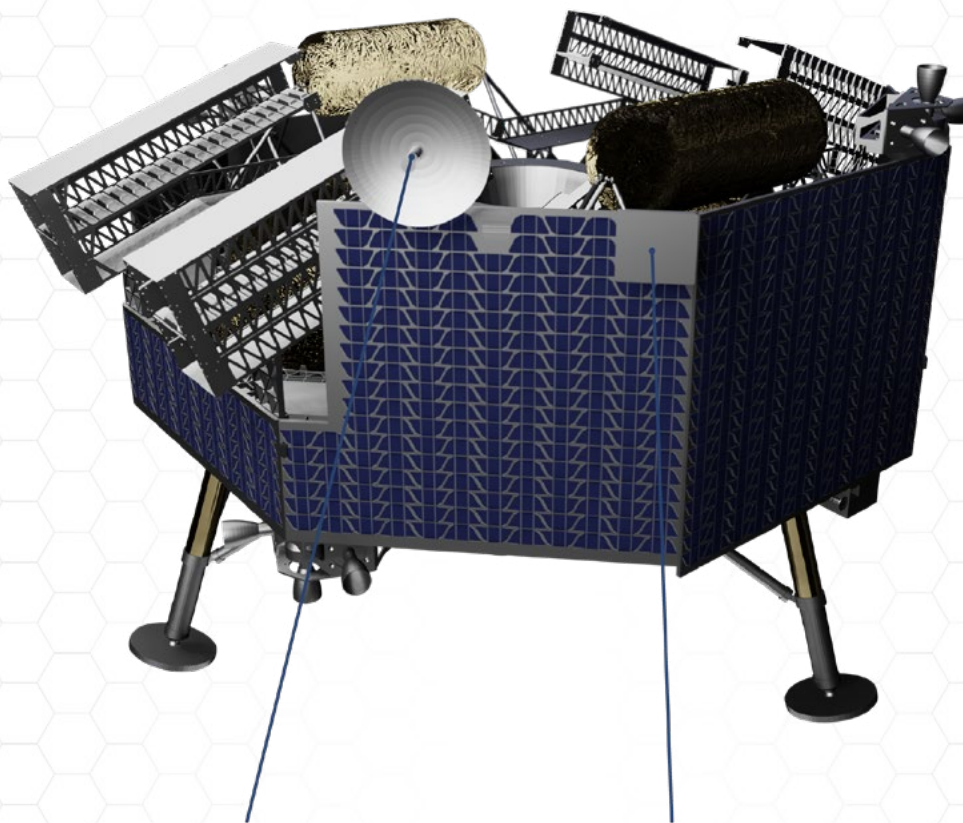

High Gain  
Antenna

Medium Gain  
Antenna

# THERMAL CONTROL



The lander is designed to implement mainly passive methods to regulate its thermal environment. Radiators are used to amass excess heat and radiate it out into space. Passive heat pipes are employed to direct excess heat to colder regions of the lander where it is needed. Layers and coatings, such as Multi-Layer Insulation (MLI), are used to protect components from undesired external thermal effects.

Some active thermal control methods, heating or cooling, may be implemented to maintain particularly stringent thermal conditions of sensitive critical components. The overall thermal design is highly mission-specific as the lander may be either hot or cold-biased depending on the extreme thermal case of each mission profile.

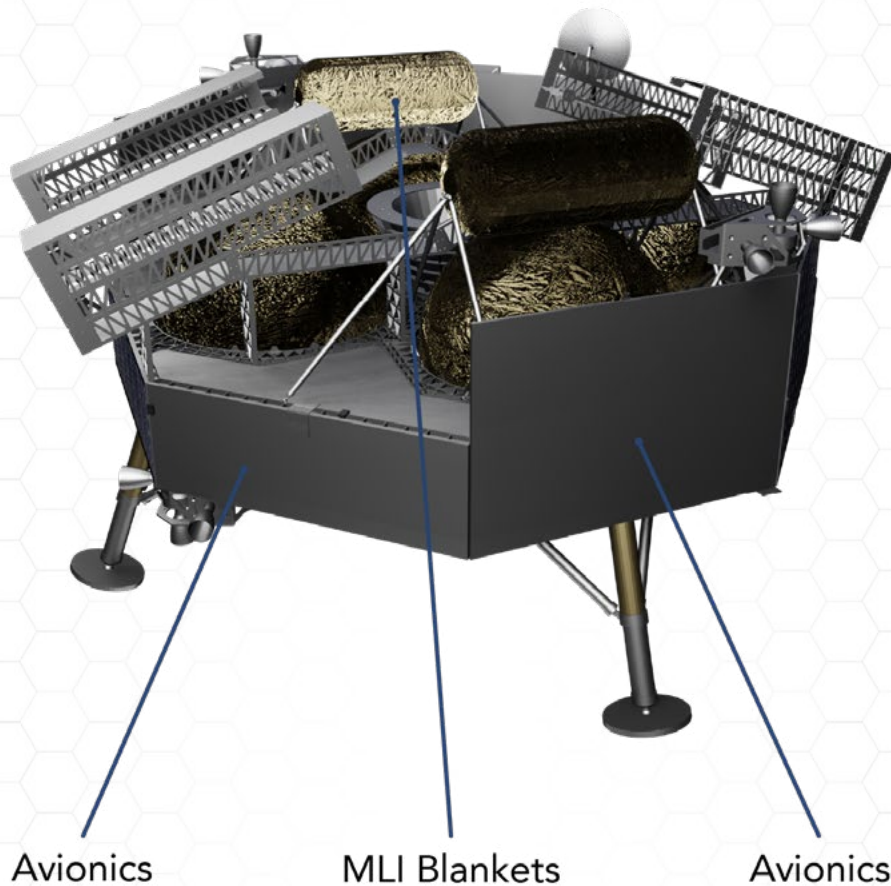



# ENVIRONMENTS



# MECHANICAL ENVIRONMENT



Astrobotic's landers' mechanical environments are enveloped by those of the launch phase. These environments, presented below, apply to the majority of payload mounting locations. However, mission-specific configurations and payload placement may impact expected loads. We will work with you to characterize payload-specific environments for relevant analysis and testing prior to integration.

## SINE VIBRATION LOADS

We perform a coupled loads analysis with the launch vehicle provider and develops sine vibration load profiles for each payload based on the mounting location, payload mass properties, launch vehicle, and specific lander configuration. Please contact us for more details.

## RANDOM VIBRATION LOADS

Random vibration loads on payloads can arise from unsteady engine combustion, exhaust noise, and turbulent flows along the launch vehicle. The plot below shows the limiting loads for random vibration along all axes. A duration of two minutes per axis may be assumed.

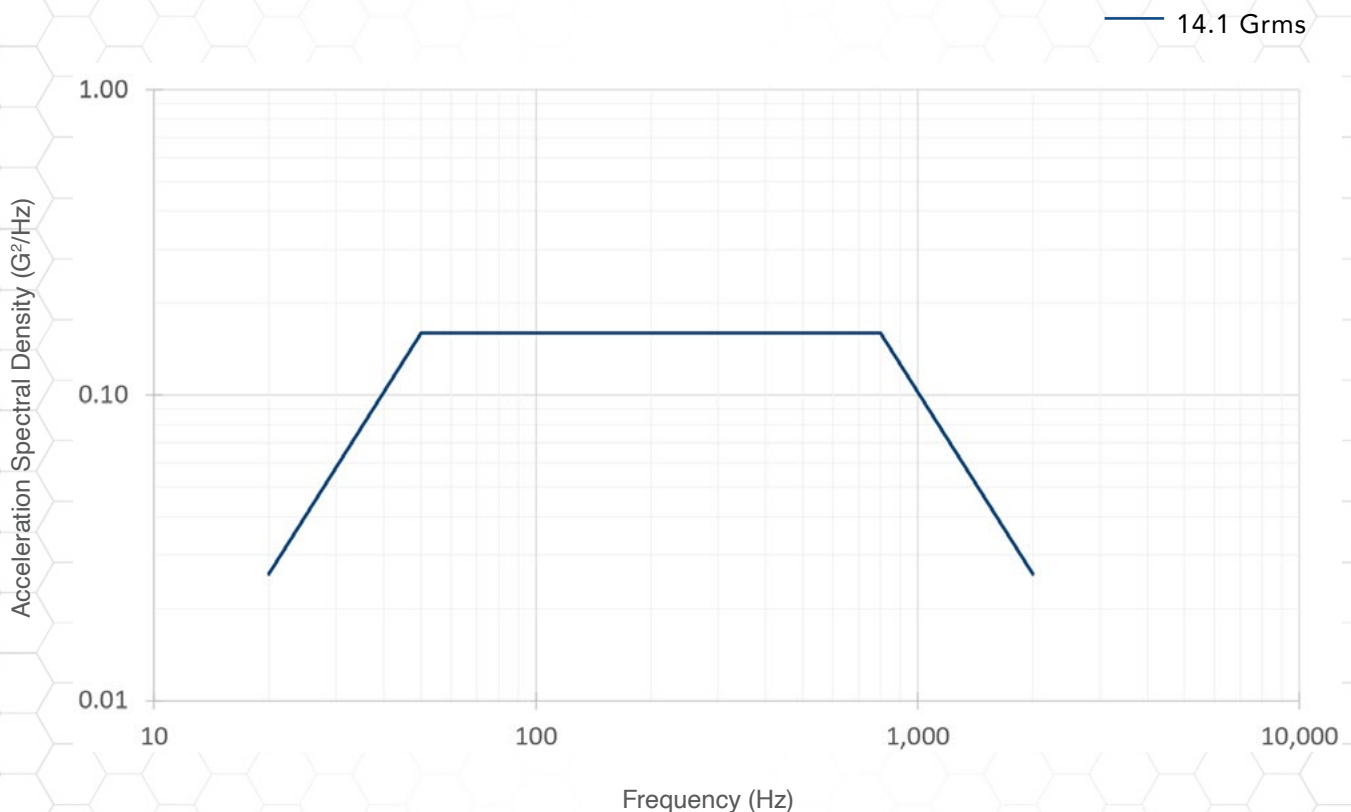



## ACOUSTIC LOADS

Payloads are subjected to sound pressure loads that reach peak levels during lift-off and transonic flight. The plot below shows limiting acoustic qualification loads. The expected duration of these loads is less than two minutes.

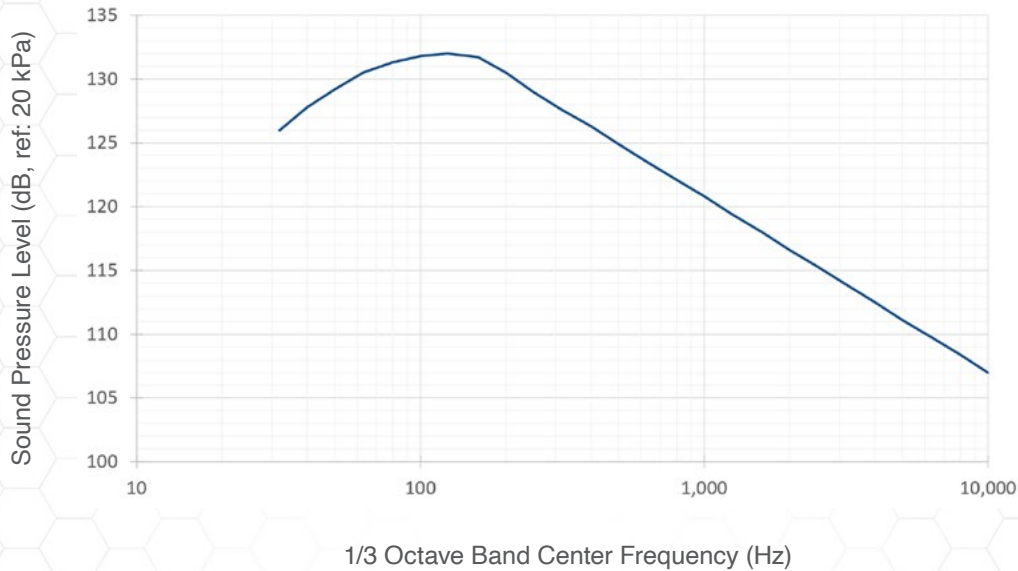

## SHOCK LOADS

Payloads also encounter multiple shock events during launch and injection. Shock events include the launch vehicle fairing release, lander separation, and landing itself. Payloads should be prepared to endure a few shock events with limiting loads as shown in the plot below.

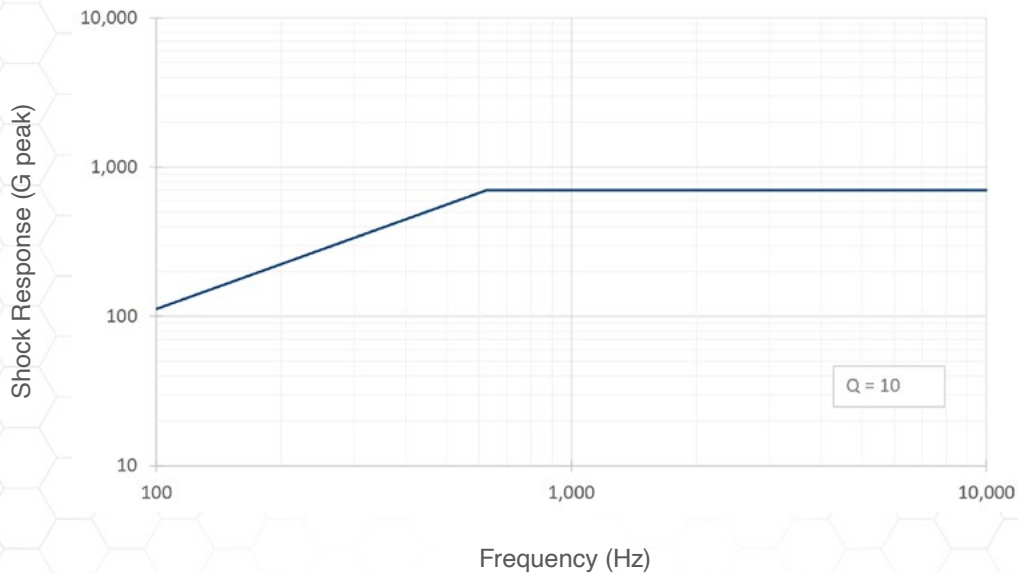

NOTE: Payloads may reference GSFC-STD-7000A (GEVS) for more details on random, shock, and acoustic environments and testing.

# THERMAL ENVIRONMENT



Astrobotic's landers encounter the following approximate thermal environments on a typical mission.

## PRE-LAUNCH (0°C TO 27°C)

The integration and launch facilities are climate-controlled to provide this specific temperature range.

## LAUNCH (0°C TO 27°C)

Throughout the launch phase, the integrated lander is encapsulated in an environmentally controlled launch vehicle payload fairing.

## CRUISE (-40°C TO 60°C)

During cruise, the thermal environment is significantly colder for objects in shadow and much hotter for objects in direct sunlight. Throughout flight, the landers are nominally oriented with the top-mounted solar panel facing the Sun. As a result, the lander's top-side receives the most incident solar radiation, and resulting heat, during the Cruise and Lunar Orbit phases. Polar configurations by contrast perform a thermal control roll during Cruise and Lunar Orbit, evenly heating the spacecraft and pointing the solar panels at the Sun.

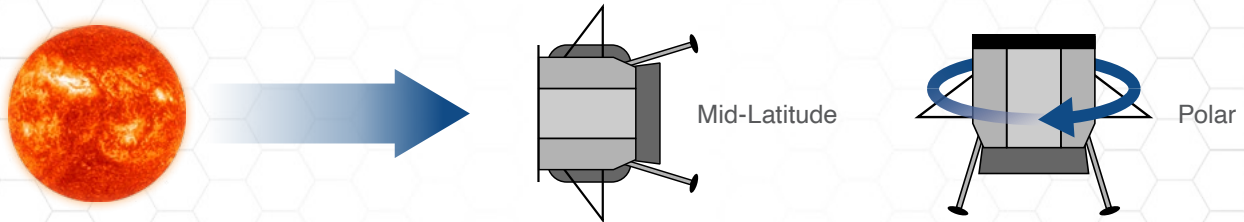



## LUNAR ORBIT (-120°C TO 100°C)

The thermal environment is significantly colder for objects in shadow, particularly during lunar eclipse, and much hotter for objects in direct sunlight, which can be compounded by light and infrared radiation from the lunar surface.

The most extreme thermal environments occur during the Lunar Orbit phase when the lander cycles through cold and hot as it passes through the Moon's shadow, shown in the representative diagram below. Peregrine nominally spends up to 24 hours in LO1 and 72 hours in LO3. The duration in LO2 is dependent on the trajectory and orbital deployment concept of operations.

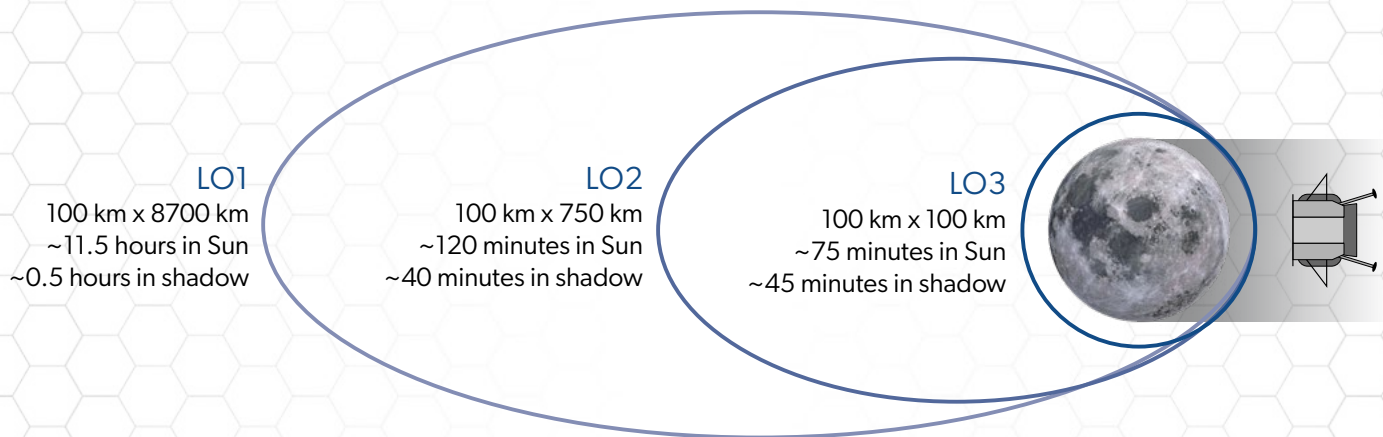

## LUNAR SURFACE (-30°C TO 80°C)

The thermal environment is significantly colder for objects in shadow and much hotter for objects in direct sunlight. This range is relevant for the nominal lunar surface operations duration and does not include lunar night or missions to equatorial latitudes.

For example, Peregrine on the lunar surface is nominally oriented such that the avionics in Enclosure A are pointed towards the lunar north pole where it is mostly or completely shadowed for the duration of lunar surface operations. The movement of the Sun throughout the lunar day and the reflection of light from the lunar surface creates thermal environments highly specific to the payload's mounting locations.

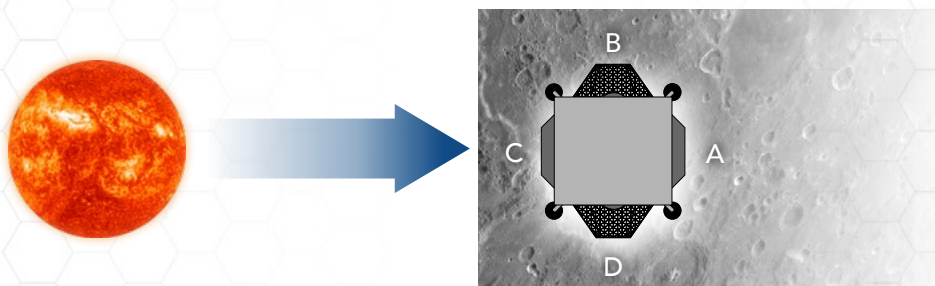

**NOTE:** The corresponding thermal environments of the payload depend on mounting location and the incident sunlight at that location throughout the mission. Astrobotic works with each customer to develop payload-specific environments for relevant system testing prior to payload integration.

# PRESSURE AND HUMIDITY ENVIRONMENT



Astrobotic's landers encounter the following approximate pressure and humidity environments on a typical mission.

## Pressure Environment

### PRE-LAUNCH

The average atmospheric pressure at sea level is 101.25 kPa. The actual value experienced by the lander will depend on the exact locations of the integration and launch facilities.

### LAUNCH

The plot below shows a typical pressure drop curve for launch, which envelopes the pressure drop for all other mission phases. The drop is expected to surpass  $-2.5$  kPa/s only briefly during transonic flight as the launch vehicle exceeds the speed of sound, and will not exceed  $-5.0$  kPa/s.

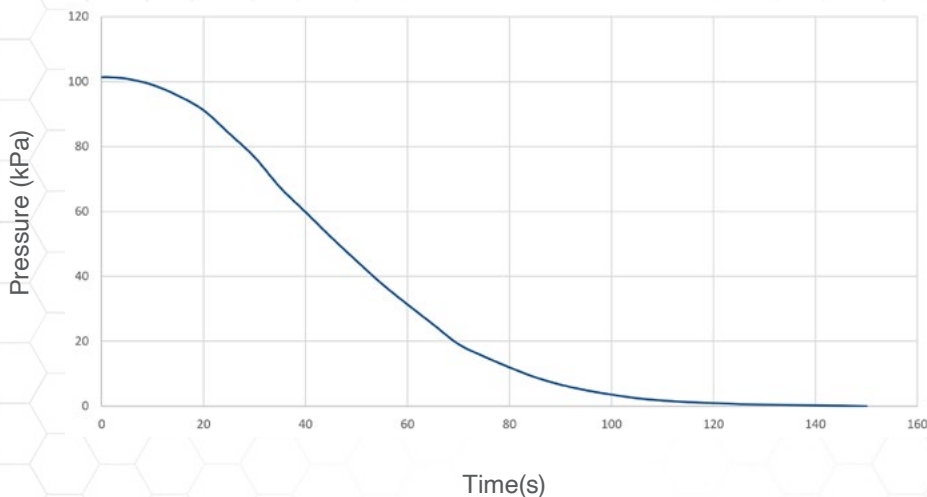

### REMAINING MISSION

For the remaining mission phases the lander will be exposed to the vacuum of the space environment, with a pressure of  $3.2 \times 10^{-5}$  kPa.

## Humidity Environment

### LAUNCH

The integration and launch facilities are climate-controlled to  $50\% \pm 15\%$  humidity. The higher humidity values may occur during transportation and depend on the local climate of the facilities' locations.

### REMAINING MISSION

The vacuum of the space environment has 0% humidity.

# CONTAMINATION CONTROL



## PRE-LAUNCH

Astrobotic maintains two ISO-Class 8 clean rooms for use during payload and lander integration. For payloads with enhanced cleanliness requirements, Astrobotic can also provide a modular ISO-Class 7 integration environment. All launch vehicle integration facilities utilized by Astrobotic also provide cleanrooms that meet these standards.



Astrobotic's Lunar Logistics Headquarters contains two ISO Class 8 cleanrooms capable of hosting four concurrent spacecraft for payload and lander integration and has an adjoining mission control center.

## CRUISE, LUNAR ORBIT, DESCENT, AND LANDING

Astrobotic in coordination with the launch vehicle and all payloads will perform contamination analysis for all phases of the mission through landing and operations on the Moon. Our engineering team is capable of performing assessments for particulate, molecular, and other contamination sources that sensitive payloads may require protection from.

A contamination control plan will be maintained throughout the mission to ensure all customer contamination requirements are met.

# RADIATION ENVIRONMENT



Astrobotic's landers are subject to an ionizing radiation environment that varies along their path to the Moon. This environment can be roughly divided into two regions: near-Earth and interplanetary. The boundary between the two is the outer edge of the Van Allen radiation belts, a set of bands containing energetic protons and electrons trapped by the Earth's magnetic field. The Van Allen belts' overall structure is illustrated in the highly simplified figure below.

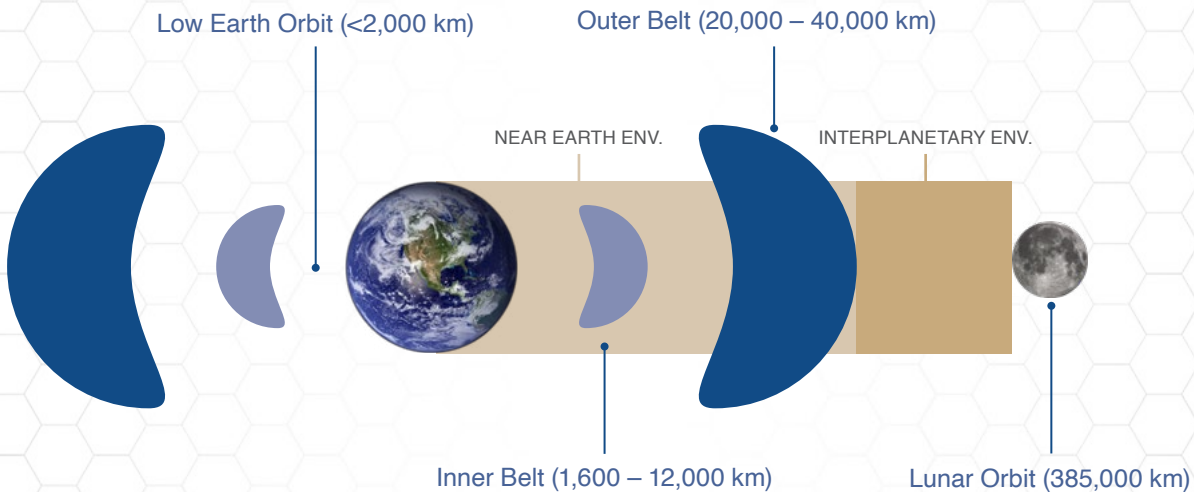

## NEAR-EARTH ENVIRONMENT

The near-Earth radiation environment is defined by the radiation trapped by the Earth's magnetic field. It can reach as high as 20 rads/day when the lander is directly passing through the Van Allen belts. This ionizing dosage is based on expected electron as well as heavy ion and proton radiation per Earth day. Our lander may spend anywhere from 1 to 15 days in this environment, depending on the specific mission trajectory, from the launch through cruise phase.

## INTERPLANETARY ENVIRONMENT

The interplanetary radiation environment occurs in the region outside of the shielding effects of Earth's magnetic field. An ionizing dosage of 1 rad/day is predicted there based on the expected electron radiation per Earth day.

## TOTAL IONIZING DOSAGE

The total ionizing dosage is not expected to exceed 1 krad for most missions. Astrobotic's landers are designed to mitigate destructive events within its own electronics caused by nominal radiation for a period of eight months.

# ELECTROMAGNETIC ENVIRONMENT



Astrobotic's landers and all payloads must be designed in compliance with radiated and conducted electromagnetic emissions (EMI) standards. The table below shows the appropriate testing to perform based on payload type (see Page X), as defined in the Requirements for the Control of Electromagnetic Interference Emissions and Susceptibility (MIL-STD-461G) document. These tests characterize the interference, susceptibility, and compatibility of the lander and payloads to ensure appropriate electrical interfacing that does not induce significant interference, noise, or performance degradation into the integrated system.

EMI CATEGORY	REQUIREMENT	APPLICABILITY
<b>Conducted Emissions</b>	CE102	Active Payloads
<b>Conducted Susceptibility</b>	CS101 CS114 CS115 CS116	Active Payloads
<b>Radiated Emissions</b>	RE102	Active Payloads
<b>Radiated Susceptibility</b>	RS103	Payloads with Antennas

Additionally, these tests inform compliance with other external standards and regulations such as Range Safety. Please contact Astrobotic for the latest version of the relevant Range Safety User Requirements Manual Volume 3 (AFSCMAN91-710V3) document.





# INTERFACES

# PAYLOAD TYPES



A payload may be either passive or active as well as either static or deployable; this results in the four distinct payload types detailed below. The standard payload interfaces, services, and operations are informed by the payload type.

	STATIC	DEPLOYABLE
PASSIVE	<p><b>Static Passive</b></p> <ul style="list-style-type: none"><li>• Remains attached to lander</li><li>• Does not perform mission tasks</li></ul> <p><i>Example: Memorabilia</i></p>	<p><b>Deployable Passive</b></p> <ul style="list-style-type: none"><li>• Detaches from lander</li><li>• Does not perform mission tasks</li></ul> <p><i>Example: Surface time capsule</i></p>
ACTIVE	<p><b>Static Active</b></p> <ul style="list-style-type: none"><li>• Remains attached to lander</li><li>• Performs mission tasks</li></ul> <p><i>Example: Science instrument</i></p>	<p><b>Deployable Active</b></p> <ul style="list-style-type: none"><li>• Detaches from lander</li><li>• Performs mission tasks</li></ul> <p><i>Example: Rover</i></p>

Astrobotic's landers provide payloads with standard and well-defined interfaces to support their missions. The following pages outline the standard physical, functional, and ground segment interfaces for payloads. The service interfaces, which provide power and data to payloads, vary both by payload type and mission phase. Service interfaces are described in the Mission Operations section. Astrobotic is able to accommodate nonstandard interfaces upon request.

Please contact Astrobotic for additional information or the latest version of the Interface Definition Document (IDD), which provides a comprehensive description of the standard interfaces.

# PAYLOAD MOUNTING ACCOMMODATIONS



Peregrine and Griffin can accommodate a wide range of payloads by providing a flexible mounting solution to accommodate payload pointing and mounting requirements. Two open isogrid aluminum decks serve as the standard payload mounting structure, a smaller deck is utilized for some deployable payloads. Alternate mounting locations, such as on the vertical enclosures or internal shear panels, are available as a nonstandard service; please contact Astrobotic for additional information.

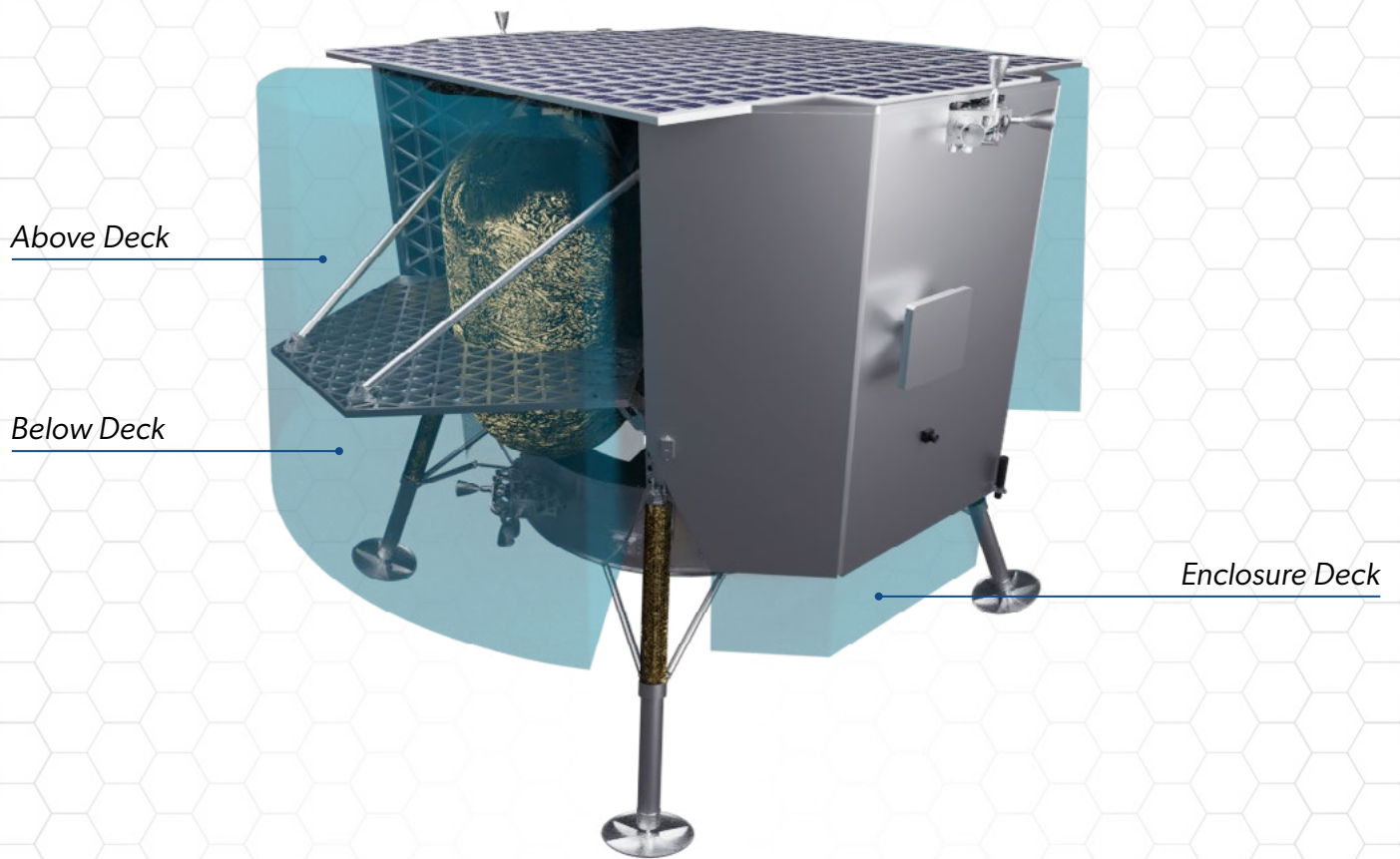

Peregrine - Standard Payload Mounting Envelopes

Astrobotic provides a volume about the payload mounting decks designated for safe and simple accommodation of payloads, known as the payload envelope. The envelope ensures safe stowage during flight and sufficient ground clearance upon landing for payloads. Astrobotic works with each payload customer to define a section of this envelope, which the payload may use as desired.

Payload operations outside of the envelope are permitted during the Surface phase. Such operations must be discussed and scheduled with Astrobotic. Egress procedures may also be performed during the Lunar Orbit phase as discussed and scheduled with Astrobotic.

# PAYLOAD MOUNTING DECKS



The payload mounting decks are the primary mounting location for payloads, featuring a standardized bolt pattern for simplified payload mounting. Most lander configurations feature two standard decks and a deck below one avionics enclosure for smaller payloads.

Each standard deck offers approximately 0.5 m<sup>2</sup> of mounting area per side. The same bolt pattern is provided on both sides of these decks. Locking helicoil inserts are sized for standard M5 bolts and are spaced 75 mm apart, from center to center. The small deck features approximately 0.2 m<sup>2</sup> of mounting area and payloads may only mount below the deck.

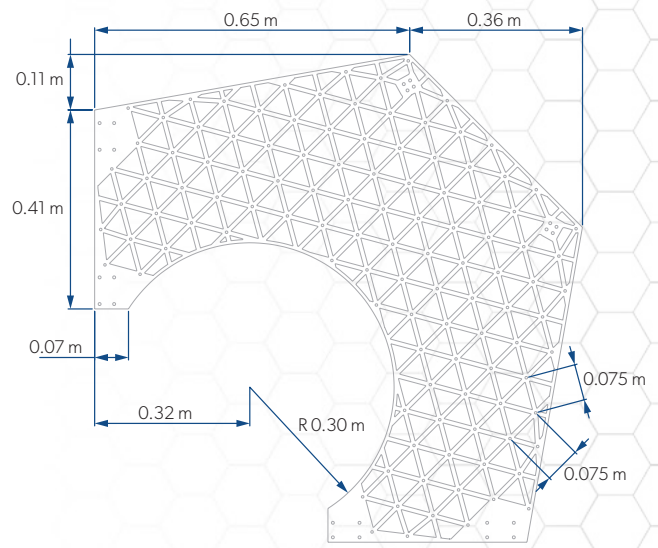
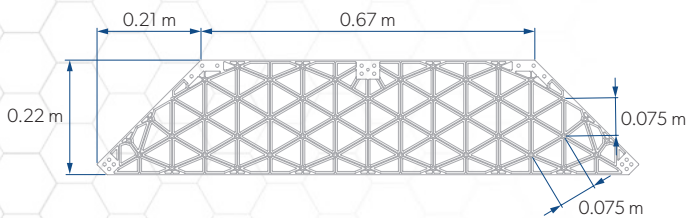

Please contact Astrobotic for more detailed drawings and dimensions of the payload mounting decks.

Astrobotic assigns specific bolt holes to every payload based on their size and mounting location requirements. Astrobotic provides a suitable number of helicoil inserts to each payload as determined by the payload size and allotted number of bolt holes.

The appropriate method for attaching a payload to its assigned helicoil inserts is illustrated in the diagram to the right. The lander deck and Astrobotic-supplied helicoil inserts are shown in gray whereas customer supplied components are shown in blue. Two payloads may utilize the same bolt hole from opposite sides of the deck as each side of the payload mounting deck is provided its own locking helicoil insert.

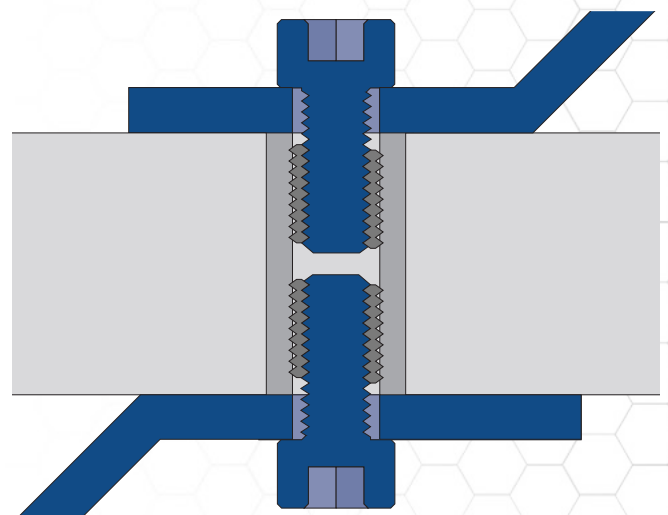

# ADAPTER PLATES



Payload placement on the lander is an iterative and cooperative process between Astrobotic and the payload customer. The final assignment of bolt holes to each payload occurs once the manifest is filled and ICD's are signed. Astrobotic recommends payloads utilize an adapter plate, which allows the payload design to progress independently of the assignment of bolt holes. The diagram below illustrates a typical payload adapter plate design. Adapter plates are considered part of a payload's mass allocation.

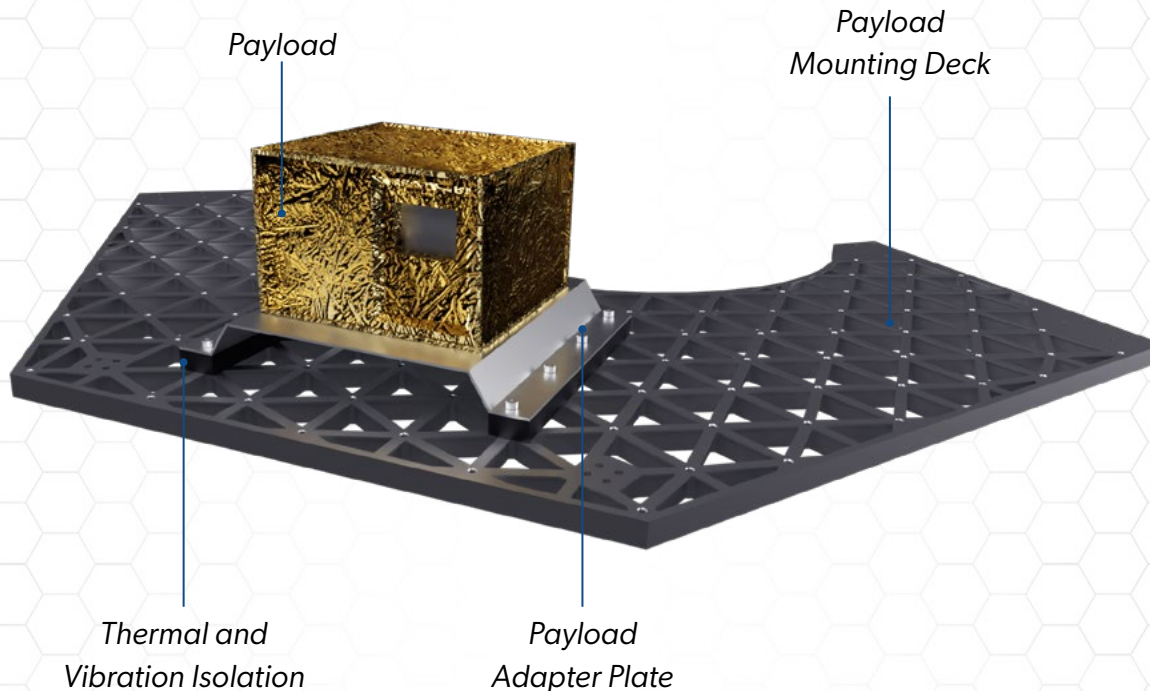

Additionally, the adapter plate can be utilized to dampen loads as experienced by the payload. It can also simplify the provision of the required thermal characteristics as well as the implementation of the required grounding, bonding, and isolation techniques at the payload mounting interface to the lander.

## THERMAL INTERFACES

The payload must implement a thermally isolating connection to the lander, defined as a conductance of  $< 0.1$  W/K. This allows the payload to more effectively regulate its own thermal environment using passive methods, such as radiators and coatings, or active methods, such as internal heaters.

## GROUNDING, BONDING, AND ISOLATION INTERFACES

The landers operate with a single-point ground architecture. Payloads must conform to this approach by employing proper grounding, bonding, and isolation schemes within their own payload design and by providing contact points for the payload structural and conductive elements as well as internal electrical circuit common ground, which Astrobotic connects to the lander chassis for grounding.

# ELECTRICAL INTERFACES



Astrobotic provides power and data services through a Standard Electrical Connector (SEC). The SEC is a Glenair SuperNine connector of the MIL-DTL-38999 Series III screw type connector. The connector is available in a regular and small size, each with a standard pin configuration providing the contacts illustrated below. Please contact Astrobotic for the specific SEC part number for your payload.

- Power
- Power Signal
- Data
- Timing
- Power Return
- Not Connected

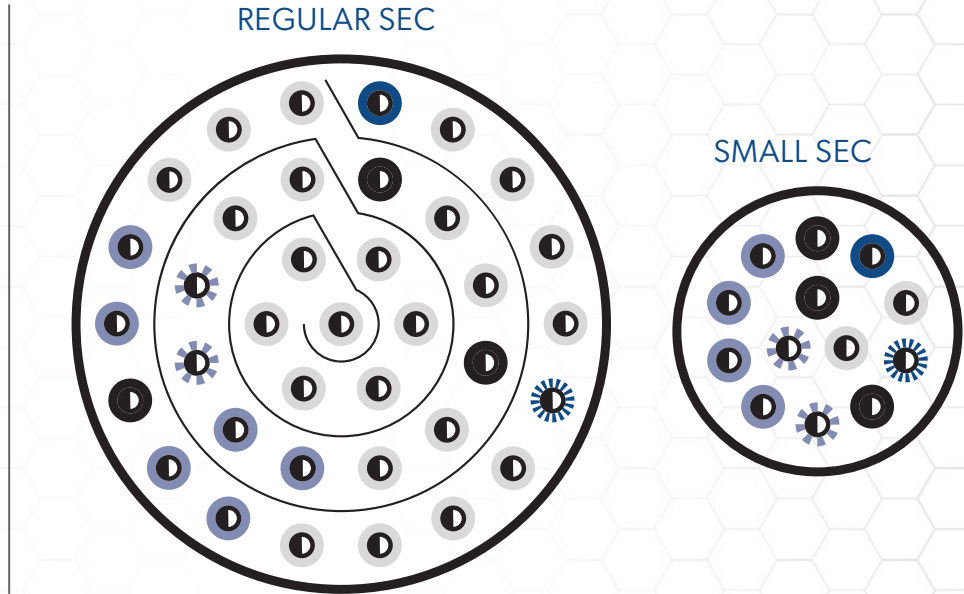

## POWER

Payloads are allocated two power circuits as a standard service. One is used for payload operations and if necessary, heater power. The other power circuit is used to perform deployments or actuations within the payload. The power provided is  $28 \pm 5\%$  Vdc and the power circuits are current regulated, current-monitored, reverse-voltage protected, and over-voltage-protected.

## DATA

Data circuits are available in either Serial RS-422 or SpaceWire configurations. Both data circuits support time at the tone, a time synchronization service that enables payloads to synchronize their internal clock with the lander and by extension UTC time. Payloads requiring the use of SpaceWire for additional data bandwidth must use the regular size SEC.

# RELEASE MECHANISMS



Payloads may deploy from the Astrobotic landers in lunar orbit or on the lunar surface. Deployable payloads require a release mechanism to detach from the lander. The customer is responsible for the selection, procurement, testing, and integration of the release mechanism they deem most suitable for their payload design in accordance with the Astrobotic guidelines and requirements.

## LUNAR SURFACE DEPLOYMENTS

For lunar surface deployable payloads, Astrobotic recommends the use of hold-down and release mechanism style devices, but the customer may select the device most suited to the payload design if it meets the following requirements:

- Non-pyrotechnic
- Creates minimal debris
- Imparts no shocks greater than 300 g's on the lander upon actuation

## LUNAR ORBIT DEPLOYMENTS

Due to the mission-critical nature of orbital payload deployments prior to landing, Astrobotic requires the use of a proven release mechanism design for lunar orbit deployable payloads. Please contact Astrobotic for more details on lunar orbit deployable payloads.

The landers provide power services and power release signal services to the SEC interface. The payload customer is responsible for integrating the release mechanism into their payload design such that it correctly interfaces with these provided services and employs the appropriate arm and fire techniques to satisfy Range Safety requirements. Please contact Astrobotic for the latest version of the Range Safety document.

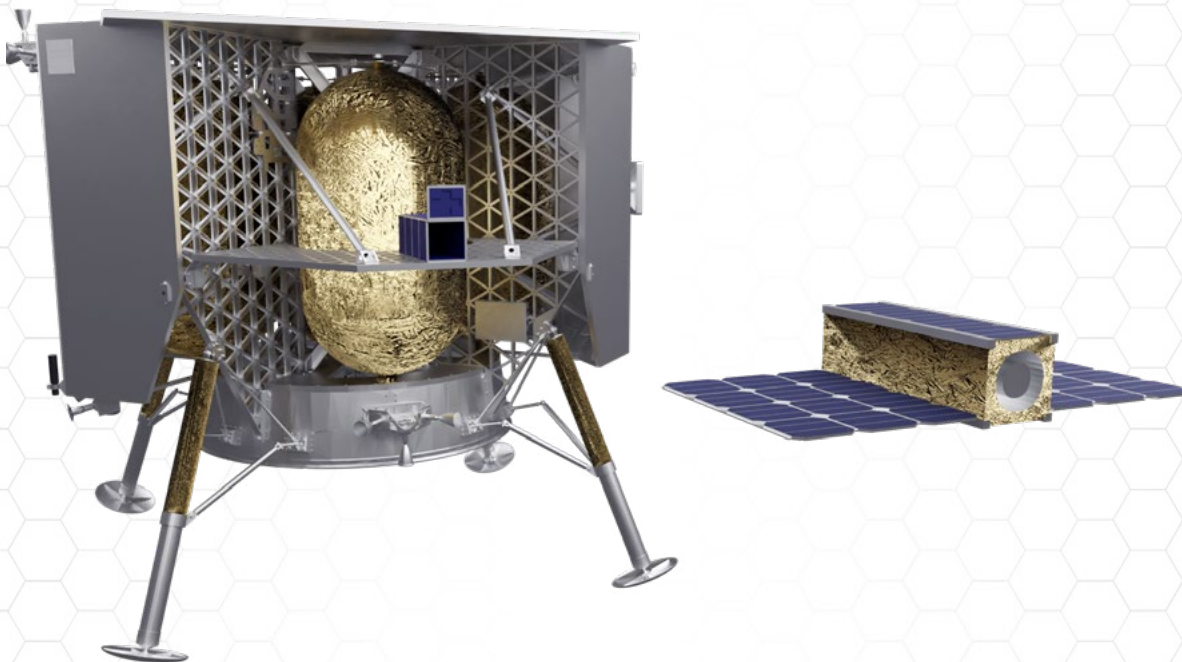

# DATA INTERFACES



Peregrine and Griffin use standard, well-defined data interfaces to simplify payload integration. Wired data services are provided through the SEC. Therefore, wired data services are available only while the payload is attached to the lander. Wireless data services are available to surface deployable payloads following separation from the lander. Orbit deployable payloads must establish an independent communication connection with Earth following separation from the lander.

## NETWORK PROTOCOLS

Payloads may select between the three networking protocols to interface with the lander. Surface deployable payloads are recommended to select a wired data interface for communications prior to separation from the lander in addition to the wireless data interface.

- Serial RS-422, Serial Line IP (SLIP), and User Datagram Protocol (UDP)
- SpaceWire high-speed wired communication

## NETWORK ARCHITECTURE

Payload telemetry and telecommands are transmitted from the lander to the Astrobotic Mission Control Center and then to the Payload Mission Control Centers without modification of payload data. Astrobotic contracts ground stations to communicate with the landers using X-Band for uplink and downlink. One-way latency in the connection between the customer and their payload on the Moon is nominally 4 seconds, although increases in latency may occur during some mission events.

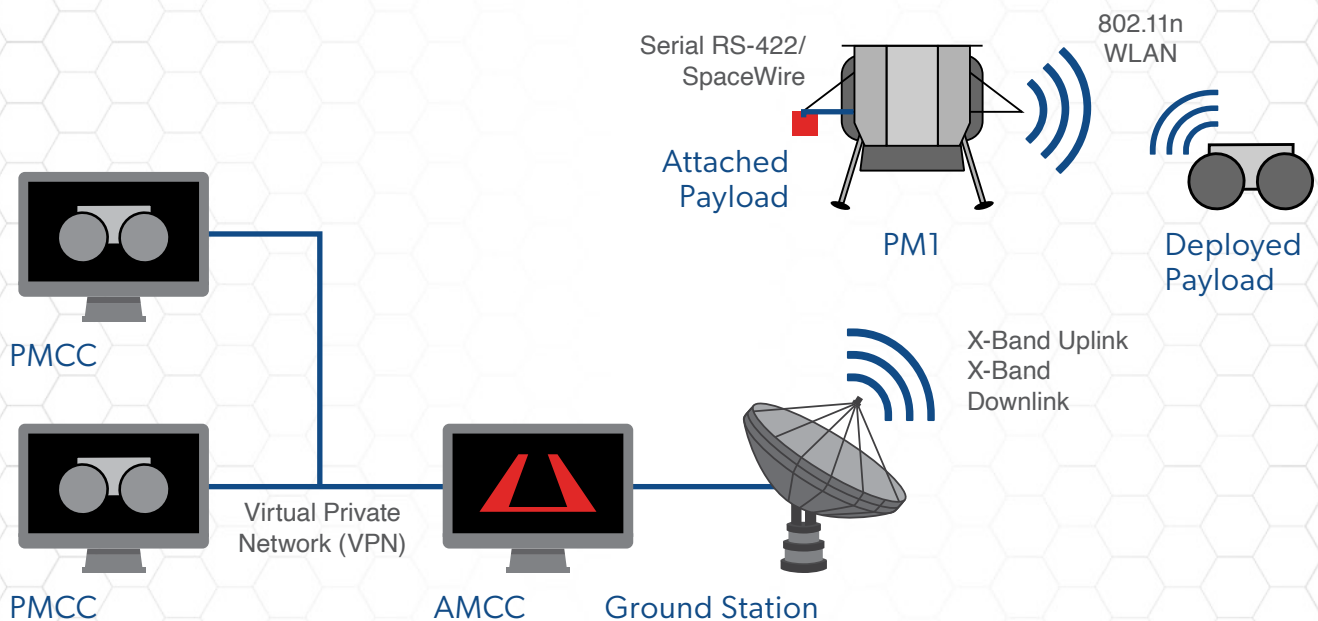



# GROUND SEGMENT



The Astrobotic Mission Control Center (AMCC) serves as the data hub for all missions, providing standardized, transparent, and safe networking to payload customers.

Payload Mission Control Centers (PMCCs) may be located adjacent to or remotely from the AMCC. Payload customers are given access to a secure and private part of the AMCC network via Virtual Private Network (VPN). Payloads that choose to operate their payloads adjacent to the AMCC do so from the Payload Operations Area. Customers may implement custom PMCC applications using whatever hardware or software is necessary to monitor and control the payload.



Rendering of the Astrobotic Mission Control Center in Pittsburgh, PA.

Astrobotic delivers payload telecommands and telemetry without modification. This system means the customer does not need to consider the different mediums and channels traversed by their data packets.

All payload telecommands and telemetry are securely addressed, and the AMCC and lander verify each packet's meta-data for compliance, ensuring safe transmissions. Customer data is not opened or reformatted allowing for payloads to implement encryption or other data security techniques.

Each payload customer is required to provide an on-site representative at the AMCC during mission operations for rapid response to off-nominal situations. This requirement may be waived for static passive payload types.



# MISSION OPERATIONS

# LANDING SITE



## PRECISION LANDING

Each mission targets a landing ellipse in a region of interest based on the mission and payload requirements. Starting with Griffin Mission One, Astrobotic will utilize the Optical Precision Autonomous Landing (OPAL) Sensor to dramatically improve the landing accuracy from a 24 km x 6 km ellipse to a 100 m x 100 m ellipse. Since GPS is not available at the Moon and other planets, the OPAL Sensor uses on-board cameras and computer vision algorithms to detect features on the lunar surface and match these features to onboard maps to provide position updates during landing. Robust, high-speed image processing allows the lander to accurately determine its pose as it descends towards the surface.

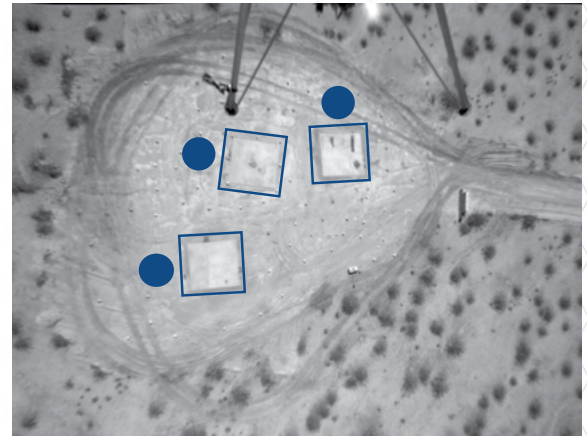
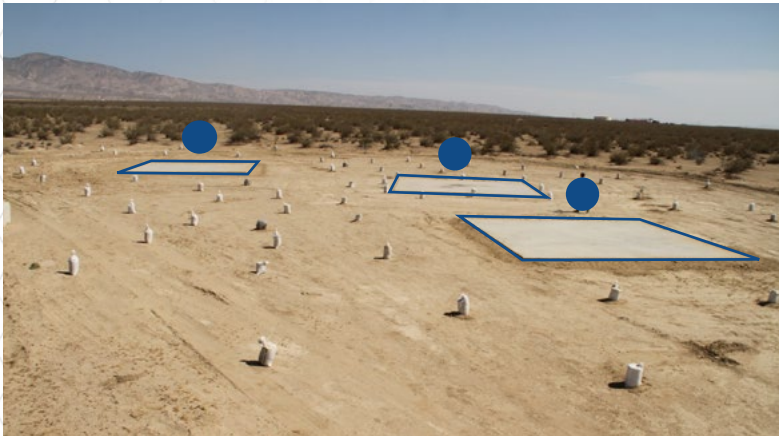

Early version of the OPAL sensor autonomously selects a hazard-free landing site for the Masten Space Systems Xombie Rocket.

## EFFECTIVE SLOPES

Potential landing sites are analyzed based on a wide array of variables; one of the most important being effective slope. The effective slope takes into account natural slopes in the topography and the presence of rocks. Sites are typically selected with an effective slope  $\leq 10^\circ$ . Sites with a maximum expected rock height of 0.3 m are preferred. Improvements to the lander system such as the terrain relative navigation system will enable Astrobotic to select many more landing sites that meet these criteria.

## LOCAL LANDING TIME

Once a landing site has been selected, Astrobotic plans a mission to maximize payload operation time on the lunar surface. For Mission One, Peregrine will land 55-110 hours after sunrise. A lunar day, from local sunrise to sunset on the Moon, is equivalent to 354 hours, or approximately 14 Earth days. At mid-latitudes, Peregrine nominally operates for 192 hours, or 8 Earth days, following landing. Some polar missions may take advantage of unique lighting conditions to operate for longer than a single lunar day.

# MISSION PROFILE



The Astrobotic mission profile encompasses five distinct phases, beginning with payload integration to the lander and concluding at the end of the mission.



# TRAJECTORY



Astrobotic selects a specific trajectory for every mission based on launch profile and landing site. A generic trajectory, typical for Lander missions, is shown below.

- Launch to High Elliptical Orbit Aboard the Launch Vehicle
- Separation from the Launch Vehicle
- Perigee Raise Maneuver
- TLI Maneuver
- Cruise Through Cislunar Space
- Lunar Orbit Insertion (LOI) Maneuver
- Lunar Orbit Hold
- Autonomous Descent Operations
- Landing on the Lunar Surface

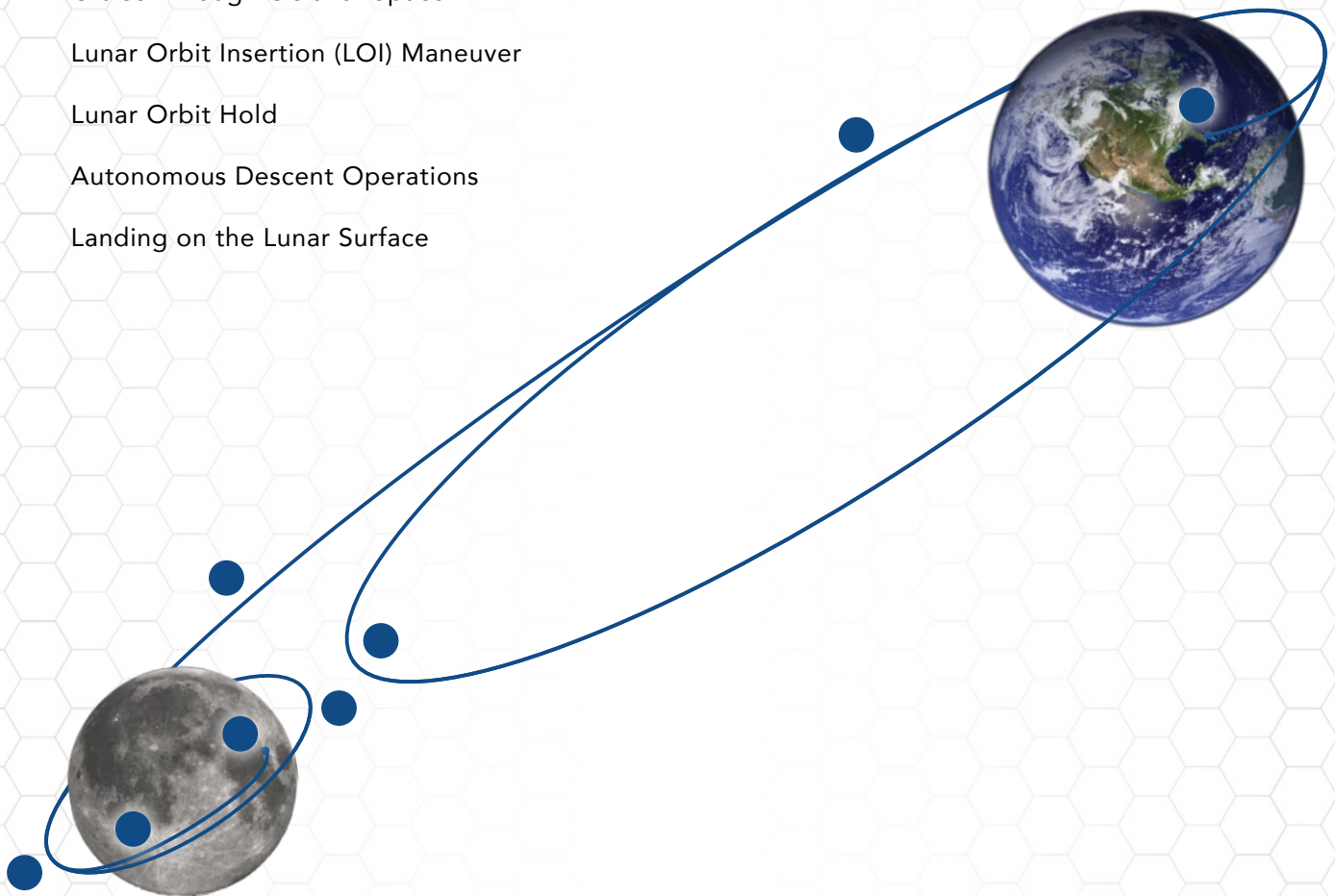

# DESCENT PROFILE



Descent operations take Peregrine and Griffin from lunar orbit safely to the surface. This phase of flight is completed autonomously by the lander.

1

## UNPOWERED DESCENT

The lander initiates descent with a braking maneuver and then coasts, using only attitude control thrusters to maintain orientation.

2

## POWERED DESCENT

As the lander approaches the surface, guided by the OPAL Sensor and Doppler LiDAR, powered descent commences; here the main engines fire continuously to slow down the lander.

3

## TERMINAL DESCENT

The OPAL Sensor and Doppler LiDAR inform targeted guidance activity to the landing site, reducing horizontal velocity.

4

## TERMINAL DESCENT NADIR

The lander descends vertically and maintains constant vertical velocity from 30 m altitude until touchdown.

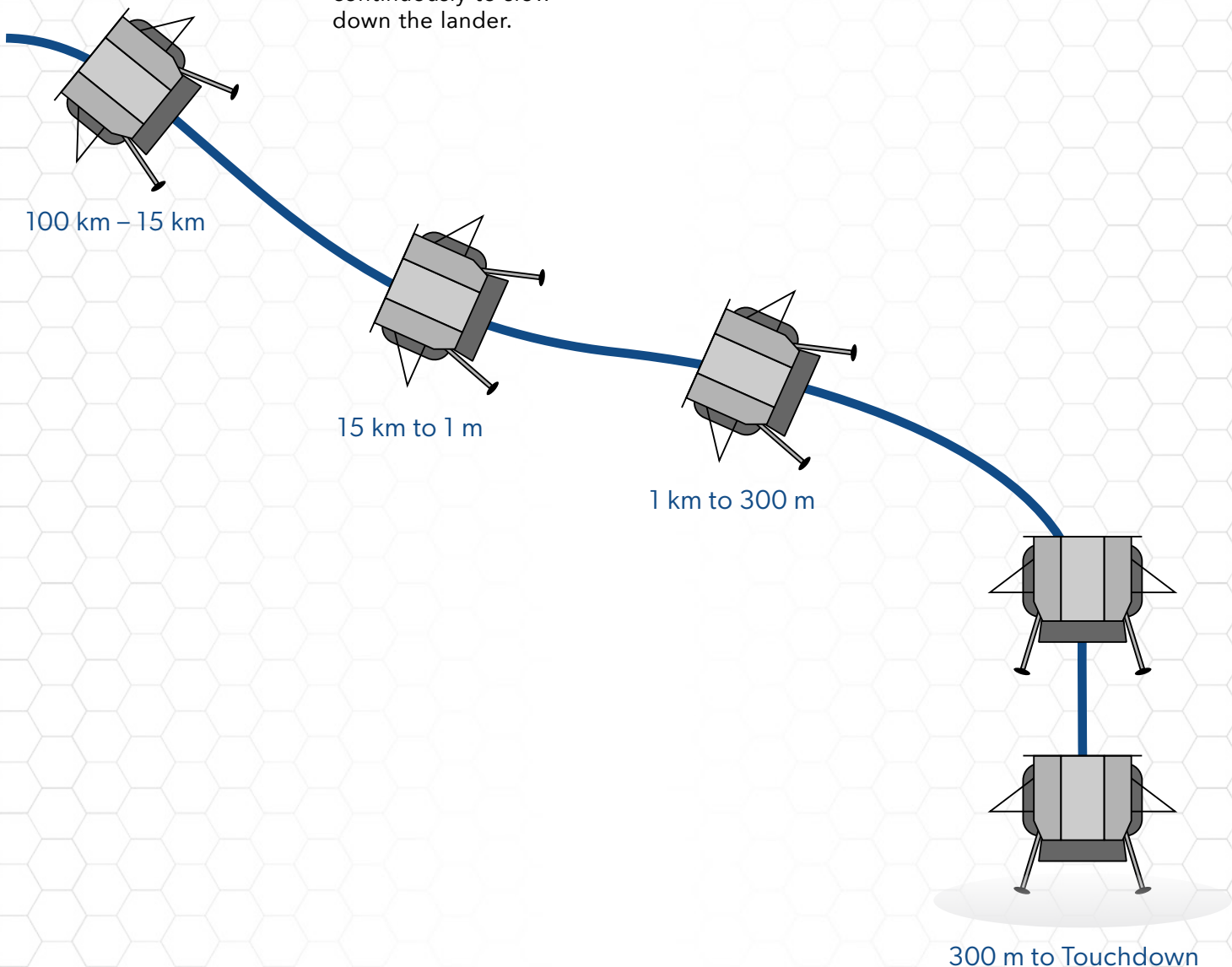

# POWER SERVICES



Our landers allocate power services based on payload mass, with several modes available to fit the payload concept of operations. Additional power services are available for purchase; please contact Astrobotic for more details. Astrobotic defines the following service modes for payloads.

- OFF** No power is provided to payloads.
- NOMINAL** 1.0 W per kilogram of payload.
- PEAK** 2.5 W per kilogram of payload as scheduled by Astrobotic.
- RELEASE** 30 W peak payload power for approximately 60 seconds.

Power service modes provided to payloads change by mission phase as described below.

	PRE-LAUNCH	LAUNCH	CRUISE	LUNAR ORBIT	SURFACE
OFF	As Scheduled	Entire Phase	< 20 minutes per lander maneuver	< 20 Minutes per Lander Maneuver <sup>1</sup>	N/A
NOMINAL	As Scheduled	N/A	Default State	Default State	Default State
PEAK	As Scheduled	N/A	N/A	N/A	As Scheduled
RELEASE	As Scheduled	N/A	N/A	As Scheduled <sup>2</sup>	As Scheduled <sup>3</sup>

<sup>1</sup> Powered descent lasts two hours and is the only lander maneuver to last more than 20 minutes.

<sup>2</sup> Only payloads delivered to lunar orbit are provided release power services in lunar orbit.

<sup>3</sup> Only payloads with deployable or actuated elements on the lunar surface are provided release

Power services are available only while the payload is attached to the lander. Deployable payloads take full control of their own power generation and consumption following release from the lander.

# DATA SERVICES



Data services also feature a base allocation by payload mass, with a nominal data rate mode on the lunar surface and a limited data-rate heartbeat mode while in transit. Additional data services are available for purchase; please contact Astrobotic for more details. Astrobotic defines the following service modes for payloads. The lander typically cycles between modes as it switches between ground stations.

**OFF** No data services are provided to payloads.

**HEARTBEAT** 10 bps per payload.

**RELEASE** 10 kbps per kilogram of payload.

*Data service modes provided to payloads change by mission phase as described below.*

	PRE-LAUNCH	LAUNCH	CRUISE	LUNAR ORBIT	SURFACE
OFF	As Scheduled	Entire Phase	4 Hours per Cycle	4 Hours per Cycle	1 Hour per Cycle
HEARTBEAT	As Scheduled	N/A	4 Hours per Cycle	4 Hours per Cycle	N/A
NOMINAL	As Scheduled	N/A	N/A	N/A	7 Hours per Cycle

Unlike power services, data services are dependent on lander contact with ground stations. For payloads the landers typically provide data services over an 8 hour cycle. Part of that cycle is spent in LOS and the rest is in

Wired services are available only while the payload is attached to the lander. Wireless data services are available to surface deployable payloads following separation from the lander. Orbit deployable payloads must establish an independent communication connection with Earth following separation from the lander.



# EGRESS PROCEDURES



Each deployable payload is given a time window to perform deployment and any payload-specific preparations. Astrobotic informs the payload customer once their egress window is open. The following compliant safe, arm, and fire techniques must be implemented in the payload design.

## SAFE

The payload deployment mechanism is disconnected from the power (release) signal circuit inside the payload, and the circuit is unpowered.

## ARM

The payload deployment is armed by means of a specific customer command to ready the payload for deployment and internally distribute power services to the release mechanism.

## FIRE

The power (release) signal serves as the fire command. Upon customer request, Astrobotic provides the defined power signal to the Standard Electrical Connector (SEC) interface.

The lander maintains power authority over attached payloads and can, by the removal of nominal power services, render payload release mechanism devices inert.

A sample egress procedure guideline is provided below.

- 1** The payload charges its batteries with power provided by the lander. The payload customer performs any necessary system diagnostic checks and firmware or software updates to prepare the payload for deployment.
- 2** Astrobotic and the payload customer enable restricted payload functionality, allowing the use of internal power systems and onboard radios. A diagnostic check may be performed by the payload customer to verify internal power sources and wireless communication.
- 3** Upon request of the payload customer, Astrobotic commands the lander to send the power (release) signal to the payload. Lander-provided power and wired communication are discontinued to the SEC.
- 4** Astrobotic and the payload customer confirm successful separation of the payload from the lander.

**NOTE:** For orbit deployable payloads, Astrobotic may interface directly with the release mechanism and apply the arm and fire signals with customer confirmation of payload readiness. If desired, this also allows the payload to deploy in an unpowered state until separation from the lander.

Astrobotic provides the following forms of confirmation of payload separation.



- 1 Confirmation of provision of the power (release) signal to the SEC interface.
- 2 Visual confirmation of payload separation using the lander status cameras.

Following deployment, all payloads are responsible for their own power management. Orbit deployable payloads also need to ensure separate communications with Earth. Please contact Astrobotic for recommendations on an independent power and communications concept of operations for payloads.

### LUNAR ORBIT EGRESS

Lunar orbit deployments introduce distinct complexities that require additional precautions to be enacted. Payloads are deployed in either the velocity or anti-velocity direction; this results in orbital dynamics that appear to loop back relative to the lander orbit. Astrobotic requires that these loop backs occur outside of a 1 km radius keep-out zone. To be compliant, payloads must provide at least 0.04 m/s velocity relative to the lander upon separation.

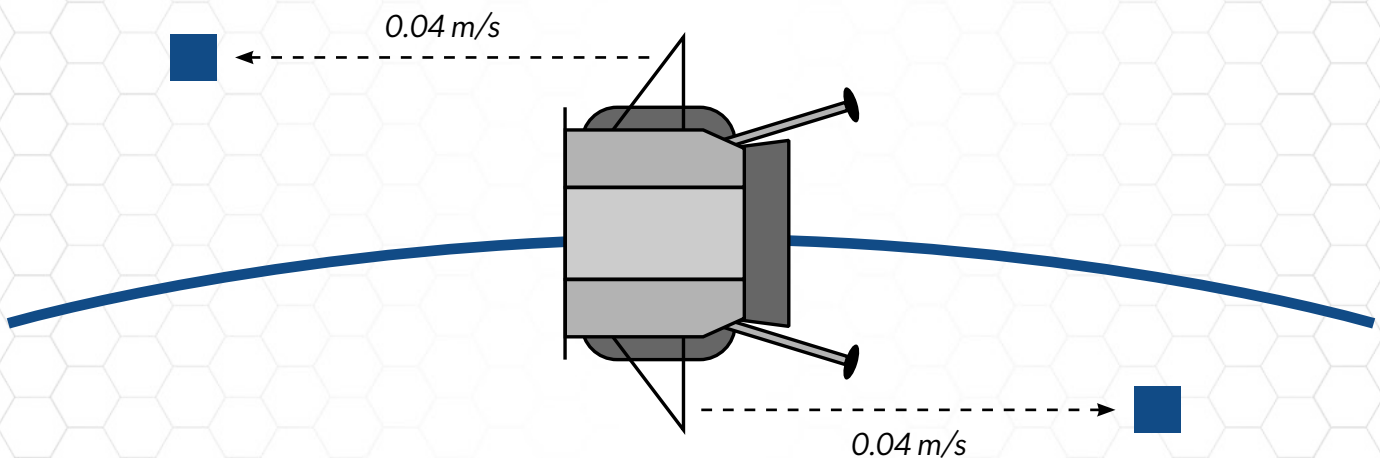

The lander nominally holds in several different lunar orbits during the Lunar Orbit phase; not all lunar orbits are available for orbital payload deployment as some may be less stable than others. Astrobotic identifies the available and preferred lunar orbits for payload customer orbital deployments for each mission. To ensure safe lunar orbit operations for all payloads, orbital deployments may occur at slightly varied altitudes for each payload.



# **PAYLOAD INTEGRATION**

# MISSION TIMELINE



The diagram below provides a high-level overview of the mission timeline. Astrobotic works with the customer to appropriately tailor this timeline to develop a payload-specific schedule based on payload type and complexity.

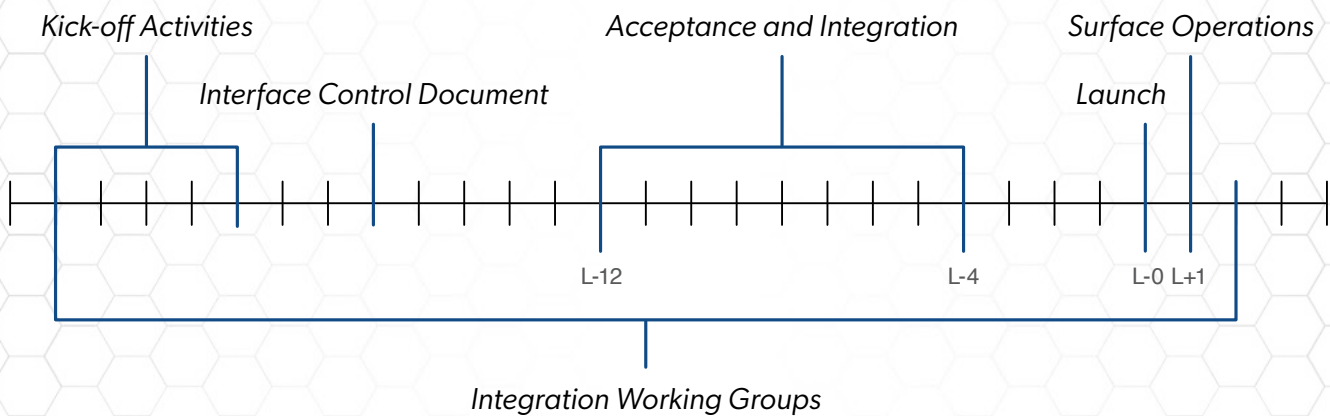

Following contract signature, Astrobotic begins hosting regular Integration Working Group meetings with each payload customer. These meetings, led by an Astrobotic Payload Manager, are the primary forum for technical and programmatic interchanges between the payload team and Astrobotic engineers. Topics for these meetings change as the mission gets closer to launch. Integration Working Group meetings continue until the end of mission.

During the kick-off Activities phase, Astrobotic works to familiarize the payload customer with the lander interfaces and concept of operations. Astrobotic maintains a comprehensive library of payload documentation to aid in this process. The Interface Definition Document (IDD) explains the standard payload interfaces and environments. The Payload Integration Plan (PIP) describes the deliverables and analyses performed by the customer and Astrobotic teams. Astrobotic then works with payload customers to develop an Interface Control Document (ICD), which defines the interface between the payload and the lander.

Payload milestone reviews such as the System Requirements Review, Preliminary Design Review, and Critical Design Review are scheduled by the payload teams and supported by Astrobotic engineers acting as reviewers. The only design review led by Astrobotic is the Payload Acceptance Review.

# INTEGRATION



## PAYLOAD ACCEPTANCE REVIEW

The Payload Acceptance Review (PAR) determines whether the payload is fit for integration with the lander. The PAR is nominally scheduled no later than 9 months prior to launch. Additional flexibility can be afforded to less complex payloads utilizing fully standard interfaces and services. The PAR nominally takes place at the Astrobotic integration facility located at the company headquarters in Pittsburgh, PA and is led by the Astrobotic payload management team.

The customer delivers the fully-assembled flight-configuration payload to Astrobotic. To be considered safe to integrate with the lander, the payload must complete all verification and validation activities without failures. The final agenda for the review is tailored to the specific payload type and complexity.

## PAYLOAD INTEGRATION

Following a successful Payload Acceptance Review, Astrobotic Integrates the payload with the lander. Integration is nominally scheduled between 9 and 5 months prior to launch. Additional flexibility can be afforded to less complex payloads utilizing fully standard interfaces and services. The integration schedule developed by Astrobotic also takes overall accessibility requirements for integration and testing into account.

Integration nominally takes place at the Astrobotic integration facility located at the company headquarters in Pittsburgh, PA and is led by the Astrobotic payload management team.

Astrobotic integrates the accepted payload with the lander. The integration specialists follow the payload-specific guidelines for integration provided by each payload customer in a Payload Operations Plan. Additional verification and validation activities are undertaken to confirm a successful integration between payload and lander. The final agenda is tailored to the specific payload type and complexity.

The Payload Integration Plan provides further details on the Integration schedule and procedures. Please contact Astrobotic for the latest version of this document.

## INTEGRATED LANDER TESTING

The fully integrated lander system is functionally tested, and several environmental tests such as thermal and vibration are performed. Once the fully integrated lander is certified, the lander is delivered to the launch site where payloads may perform final functional tests and the lander is integrated with the launch vehicle.

**NOTE:** The customer may request or require additional time between the PAR and Integration. Astrobotic reserves the right to repeat aspects of the PAR to ensure any changes to the payload in that time did not impact Astrobotic's ability to accept the payload for integration.



# **GLOSSARY**

# GLOSSARY



## UNITS

<b>bps</b>	bits per second [data rate]
<b>dB</b>	decibel [sound pressure level referenced to $20 \times 10^{-6}$ Pa]
<b>°</b>	degree [angle, latitude, longitude]
<b>°C</b>	degree Celsius [temperature]
<b>g's</b>	Earth gravitational acceleration [9.81 m/s <sup>2</sup> ]
<b>Hz</b>	Hertz [frequency]
<b>kg</b>	kilogram [mass]
<b>kPa</b>	Kilopascal [pressure]
<b>m</b>	meter [length]
<b>N</b>	Newton [force]
<b>%</b>	percent [part of whole]
<b>rad</b>	rad [absorbed radiation dose]
<b>s</b>	second [time]
<b>\$</b>	United States dollars [currency]
<b>V (dc)</b>	Volt (direct current) [voltage]
<b>W</b>	Watt [power]

## TERMS

<b>AMCC</b>	Astrobotic Mission Control Center
<b>APR</b>	Astrobotic Payload Requirement
<b>EMI</b>	Electro-Magnetic Interference
<b>FPGA</b>	Field Programmable Gate Array
<b>GNC</b>	Guidance, Navigation, and Control



<b>IAU</b>	Integrated Avionics Unit
<b>IWG</b>	Integration Working Groups
<b>LOI</b>	Lunar Orbit Insertion
<b>M1</b>	Mission One
<b>M2</b>	Mission Two
<b>MMH</b>	MonoMethylHydrazine
<b>MON-25</b>	Mixed Oxides of Nitrogen - 25% nitric oxide
<b>PMCC</b>	Payload Mission Control Center
<b>SEC</b>	Standard Electrical Connector
<b>SEU</b>	Single Event Upset
<b>UDP/IP</b>	User Datagram Protocol / Internet Protocol
<b>TLI</b>	Trans-Lunar Injection
<b>VPN</b>	Virtual Private Network

## DOCUMENTATION

<b>ICD</b>	<h3>Interface Control Document</h3> <p>The document defines the final lander-payload interfaces and is signed by Astrobotic and the customer; the IDD is used as a template for this document.</p>
<b>IDD</b>	<h3>Interface Definition Document</h3> <p>The document defines the standard lander-payload interfaces.</p>
<b>PIP</b>	<h3>Payload Integration Plan</h3> <p>The document details the Payload Acceptance Review and Integration schedules as well as verification and validation procedures.</p>
<b>POP</b>	<h3>Payload Operations Plan</h3> <p>The document details the appropriate handling of the payload system; it is produced in part by the payload customer and guides Astrobotic operations.</p>
<b>PSA</b>	<h3>Payload Services Agreement</h3> <p>The document serves as the initial contract between Astrobotic and the payload customer; it defines programmatic expectations.</p>





<b>PUG</b>	<h3>Payload User's Guide</h3> <p>The document provides a high-level overview of the vehicle, mission, as well as the interfaces and services provided to payloads. (this document)</p> <hr/>
<b>SOW</b>	<h3>Statement of Work</h3> <p>The document outlines the responsibilities of Astrobotic and the payload customer; it is part of the PSA.</p> <hr/>
<b>MILESTONES</b>	
<b>CDR</b>	<h3>Critical Design Review</h3> <p>The review focuses on the final design of the lander/payload and determines readiness to proceed with fabrication and testing.</p> <hr/>
<b>FRR</b>	<h3>Flight Readiness Review</h3> <p>The review focuses on the integrated launch vehicle and determines readiness to proceed with launch operations.</p> <hr/>
<b>LRR</b>	<h3>Launch Readiness Review</h3> <p>The review focuses on the integrated launch vehicle and determines readiness to fuel the vehicle and proceed with launch operations.</p> <hr/>
<b>ORR</b>	<h3>Operational Readiness Review</h3> <p>The review focuses on the ground segment and determines end-to-end mission operations readiness.</p> <hr/>
<b>PAR</b>	<h3>Payload Acceptance Review</h3> <p>The review focuses on the flight-model payload and determines readiness to integrate with the lander.</p> <hr/>
<b>PDR</b>	<h3>Preliminary Design Review</h3> <p>The review focuses on the preliminary design of the lander/payload and determines a feasible design solution to meet mission requirements exists.</p> <hr/>
<b>SIR</b>	<h3>System Integration Review</h3> <p>The review focuses on the flight lander/payload systems and determines readiness to proceed with assembly and testing.</p> <hr/>
<b>TRR</b>	<h3>Test Readiness Review</h3> <p>The review focuses on the integrated lander and determines readiness to proceed with testing.</p> <hr/>

# CONTACT US



Astrobotic provides several points of contact to address the varied needs of payload customers.

## **BUSINESS DEVELOPMENT**

Our Business Development team is available to current and potential customers for questions on the products and services we provide.

## **CUSTOMER RELATIONS**

Our Customer Relations team is available to signed customers for general programmatic inquiries.

## **PAYLOAD MANAGEMENT**

Our Payload Management team is available to signed customers for any mission-specific or technical needs.

To begin your payload journey, please contact us and we will be happy to direct you to the appropriate Astrobotic team member.

Email us at:  
**PAYLOAD@ASTROBOTIC.COM**

We can also be reached using the following contact information:

**1016 N. LINCOLN AVENUE  
PITTSBURGH, PA 15233  
412-682-3282  
WWW.ASTROBOTIC.COM  
CONTACT@ASTROBOTIC.COM**

# QUESTIONNAIRE



For a more personalized experience, please include your specific payload needs when you contact us.

---

Payload Name

---

Payload Point of Contact: Name, Email/Phone

---

Payload Mission Objectives

---

Payload Preferred Launch Date

---

Payload Delivery Location: Lunar Destination [Orbit/Surface], Additional Parameters (e.g., orbital altitude, orbital inclination, surface region, proximity to a lunar surface feature)

---

Payload Mass

---

Payload Dimensions: Length x Width x Height, Description of Shape

---

Payload Power Needs: Nominal Power [Yes/No], Power (Release) Signal [Yes/No], Additional Needs

---

Payload Communications Needs: Wired Communication [Yes/No], Wireless Communication [Yes/No], Nominal Surface Bandwidth [Yes/No], Heartbeat Bandwidth [Yes/No], Additional Needs

---

Payload Concept of Operations

---

Additional Requirements

NOTE: You can also share your payload mission details with us through our website:  
**[Configure Your Mission](#)**