



Dolby Atmos[®] Home Theater Installation Guidelines

Dec 2018

CONTENTS

Preface: How to Use This Guide

1. Background on Dolby Atmos
2. General Dolby Atmos Home Setup Guidelines
 - Dolby Atmos Home Playback
 - Dolby Atmos Home Theater Speaker Options
 - Use of Existing Speakers
 - Overhead Speakers
 - Use of Existing Overhead Speakers
 - Alternatives to Overhead Speakers
 - Dolby Atmos Enabled Speakers
 - Combination: Overhead and Dolby Atmos Enabled Speakers
 - AVR Connection and Setup
 - Speaker-Level Calibration and EQ
3. Standard Speaker Configurations
 - Dolby Conventions for Speaker Configurations
 - Standard Setup for Both Overhead Speakers and Dolby Atmos Enabled Speakers
4. Additional Speaker Placement Guidelines
 - Listener-Level Speaker Placement Guidelines
 - Height Speaker Placement Guidelines
5. Dolby Surround Upmixer

Preface: How to Use this Guide

This document contains recommendations and best practices for setting up a Dolby Atmos® home theater system. The guidelines are intended to cover a typical home theater in a standard listening space. This document does not cover all possible variables, room layouts, and factors for specific installations; adaptations and deviations may be required in particular situations.

Dolby Atmos is a highly flexible solution, so minor variations from these recommendations are unlikely to materially detract from the immersive Dolby Atmos experience.

1. Background on Dolby Atmos

Many leading Hollywood movies, including recent Academy Award® winning films, are presented in Dolby Atmos, as this revolutionary sound technology allows filmmakers unprecedented realism and creative freedom. With Dolby Atmos, content creators can precisely place and move sounds almost anywhere, including overhead, to create an immersive listening experience.

Dolby Atmos technology is now available for the home and produces a listening experience never before experienced in a home theater. You'll get a great immersive experience, no matter what kind of Dolby Atmos home theater setup you have. Dolby Atmos content is mixed as audio objects instead of traditional channels. This means the content is not tied to any specific playback configuration. Further, the technology automatically adapts the object audio to take full advantage of the number and placement of your speakers, from systems with five speakers on the floor and two speakers producing overhead sound up to a Dolby Atmos system with as many as 24 speakers on the floor and 10 overhead speakers.

The naming of Dolby Atmos speaker configurations is based on the standard nomenclature (stereo, 5.1, and 7.1) but adds a number at the end to specify the number of height speakers in the playback system. For example, when we refer to a 5.1.4 setup, the 5 indicates the left, center, right, left surround, right surround, left rear surround, and right rear surround speakers; the .1 indicates the subwoofer; and the .4 indicates the four speakers that play overhead sound (left top front, right top front, left top rear, and right top rear).

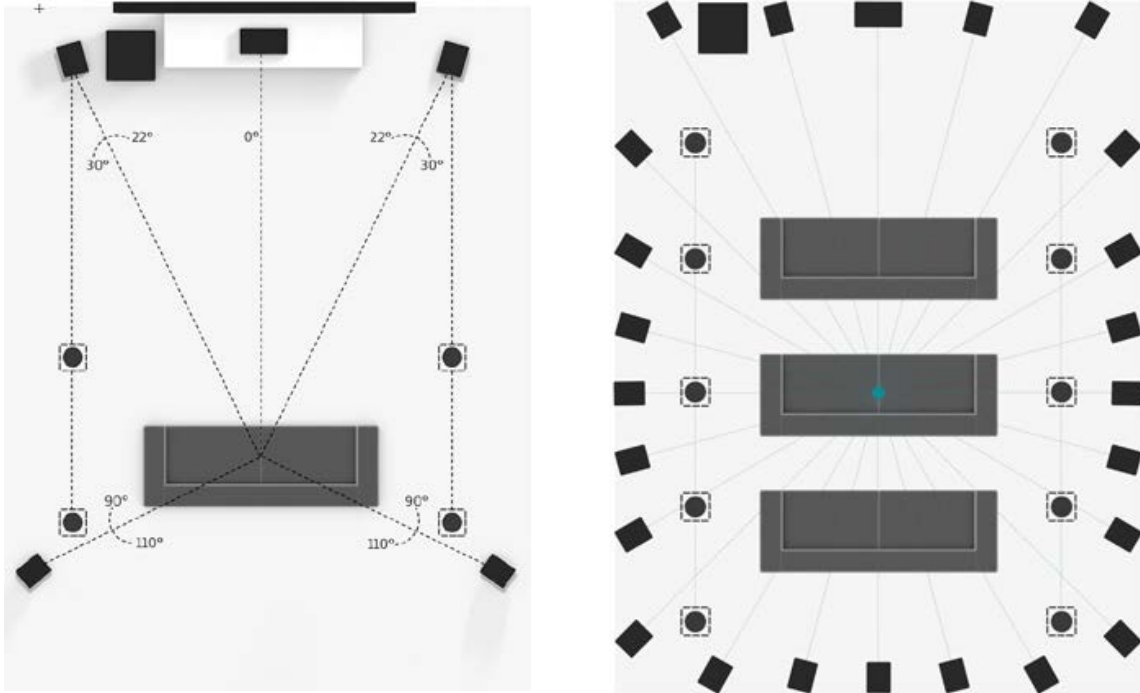

Figure 1: At left is a Dolby Atmos system with five speakers on the floor and four overhead speakers; at right is a Dolby Atmos system with up to 24 speakers on the floor and 10 overhead speakers.

Additionally, a new Dolby® surround upmixer allows for channel-based content that has not been mixed for Dolby Atmos to be expanded to fill the flexible speaker layouts of a Dolby Atmos system.

These installation guidelines are intended to be a resource for integrating Dolby Atmos into a home theater system and unlocking the potential of this revolutionary audio format. Details include the use of conventional overhead speakers and Dolby Atmos enabled speaker technology, which enables you to architect a system capable of reproducing overhead sound, even if you're not able to put speakers in or on the ceiling.

2. General Dolby Atmos Home Setup Guidelines

The following components are needed to set up a Dolby Atmos home theater system:

- A source device to play Dolby Atmos content. Many existing devices will work.
- An A/V receiver (AVR) or processor unit capable of supporting Dolby Atmos.
- Speakers to reproduce overhead audio.
- Speakers to reproduce listener-level audio. Note: In many cases, you can use existing speakers in a Dolby Atmos home theater.¹

Dolby Atmos Home Playback

Source device options to play or stream content

To experience this sound revolution, you'll need a way to play or stream Dolby Atmos content. There are a few pathways into the home theater:

- You can play Dolby Atmos content encoded on a Blu-ray Disc™ through an existing Blu-ray Disc player. Be sure you have a recent player that is fully compliant with Blu-ray™ specifications.²
- You can stream Dolby Atmos content from a compatible game console, Blu-ray, or streaming-media player, or from an application built into certain smart TVs.
- You can play games with Dolby Atmos soundtracks from a PC via HDMI® connected to your Dolby Atmos enabled AVR or processor.
- You can play Dolby Atmos content from your Dolby Atmos enabled cable set-top box if you are in a region where this is available.

In all cases, be sure to set the audio output of your device to bitstream output and ensure that secondary audio functionality is disabled. Connect the devices to your Dolby Atmos enabled AVR using an HDMI connection.³

AVR or processor capable of supporting Dolby Atmos

You can assemble a system from a wide range of available A/V components, starting with an AVR or preprocessor that supports Dolby Atmos decoding and rendering. Almost all leading AVR manufacturers have multiple product offerings available that support Dolby Atmos playback for the home.

¹ With the exception of the center and center surround speakers, all speakers in a Dolby Atmos playback system (listener level, overhead, and Dolby Atmos enabled) must be added in pairs.

² You will not need to replace your Blu-ray player as long as it fully conforms to the Blu-ray specification. Current-generation Blu-ray players, and most recent players, are compatible. You should check with the Blu-ray player manufacturer if you encounter problems.

³ Decoding and rendering of Dolby Atmos content is managed entirely by the AVR. To properly pass the Dolby Atmos audio to the AVR, source devices must be connected to the AVR via HDMI 1.4 or later and set to audio bitstream out. For Blu-ray players, the secondary audio mixing option must be disabled.

Dolby Atmos Home Theater Speaker Options

The dimension of height—hearing sounds coming from above you—is key to the Dolby Atmos experience. Reproducing overhead sounds requires new thinking about home theater design.

You have several different speaker options for a Dolby Atmos home theater system, and you will not likely have to replace all of your current speakers.

Many channel-based home theater systems have either five or seven speakers positioned at about ear level and a subwoofer. In this document, we refer to these speakers as being at the listener level. Any speaker type that is capable of accurately representing a stereo pan is suitable to reproduce objects.

As in the past, the placement of all listener-level speakers should follow these recommendations, which are based on ITU-R BS.775-3:

- The speakers located in the front of the room shall be used as a reference point. All speakers in the listener plane should ideally be equidistant from the listener position. If this is not possible, compensating for distance may be used to time align the arrival of audio from each speaker to the listener.
- All listener speakers should be at the same height, typically 3.9 feet (1.2 meters), which is ear level for the average seated listener (as defined in ITU-R BS.1116-1).

If possible, the height of the rear speakers should be the same as the height of the front speakers. If the room design makes this impractical or impossible, the rear speakers may be positioned higher than the front speakers. However, we suggest that the height of the rear speakers not be more than 1.25 times the height of the front speakers.

Use of Existing Speakers

Most existing speakers within current home theaters will work for Dolby Atmos playback. Floor-standing, stand-mounted, on-wall, and in-wall speakers that currently produce audio at the listener level can be complemented with overhead speakers and/or Dolby Atmos enabled speakers to generate the height plane of overhead sounds. You can also add more speakers at listener level or above, if the AVR or preprocessor supports them, to add greater precision to object audio placement and movement. With the exception of the center and center surround speakers, all speakers in a Dolby Atmos playback system must be added in pairs.

Note: Dipole surround speakers are not recommended for use for Dolby Atmos playback.

Overhead Speakers

Overhead sound is a vital part of the Dolby Atmos experience. There are a variety of options for adding this capability to a room.

One solution is to install speakers overhead. Most conventional overhead speakers with wide dispersion characteristics will work in a Dolby Atmos home theater.

Overhead speaker characteristics

Dolby Atmos audio is mixed using discrete, full-range audio objects that may move around anywhere in three-dimensional space. With this in mind, overhead speakers should complement the frequency response, output, and power-handling capabilities of the listener-level speakers. Choose overhead speakers that are timbre matched as closely as possible to the primary listener-level speakers. Overhead speakers with a wide dispersion pattern are desirable for use in a Dolby Atmos system. This will ensure the closest replication of the cinematic environment, where overhead speakers are placed high above the listeners.

Mounting considerations

If the chosen overhead speakers have a wide dispersion pattern (approximately 45 degrees from the acoustical reference axis over the audio band from 100 Hz to 10 kHz or wider), then speakers may be mounted facing directly downward. For speakers with narrower dispersion patterns, those with aimable or angled elements should be angled toward the primary listening position.

The overhead speakers should be at a height (shown as H3 in Figure 2) between two and three times the vertical position of the listener-level speakers. The angle of elevation from the listening position to the left top front/right top front and left top rear/right top rear overhead speakers in a 7.1.4 reference layout should be 45 degrees. This may be adjusted between 30 and 55 degrees if needed, as shown in Figure 2. Figures 3 and 4 show the preferred locations of the four overhead speakers as seen from above. The horizontal width should be about the same as the horizontal separation of left and right speakers placed at ± 30 degrees. If this guidance is followed, the overhead side-to-side separation should be 0.5 to 0.7 of the width of the overall layout, depending on the distance to the screen and the front three speakers, relative to the surrounds. It is best to keep the overhead arrangement centered, front to back, over the listening area, even if the front speakers and screen are at a greater distance than the surround speakers.

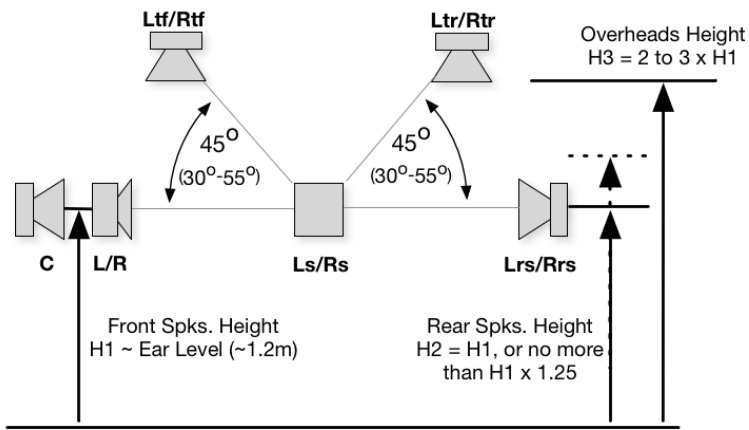

Figure 2: Vertical position of front, surround, and overhead speakers.

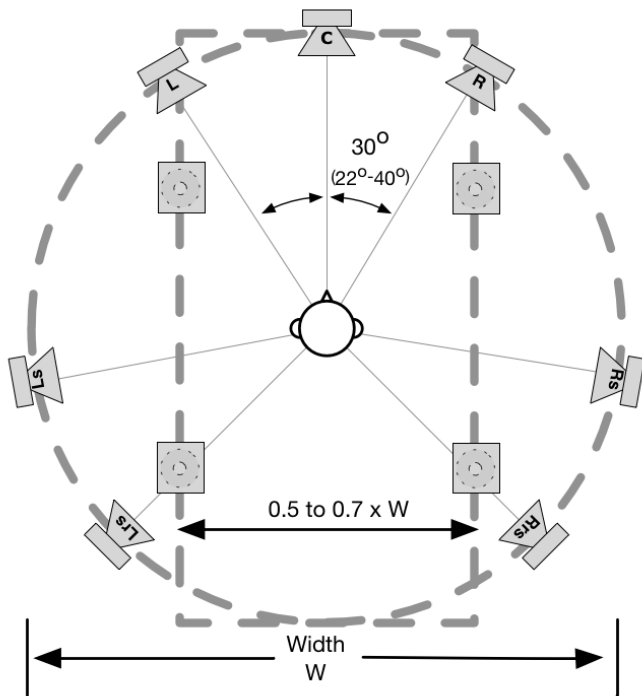

Figure 3: Top view, listener-level and height (overhead) speakers in a 7.1.4 configuration.

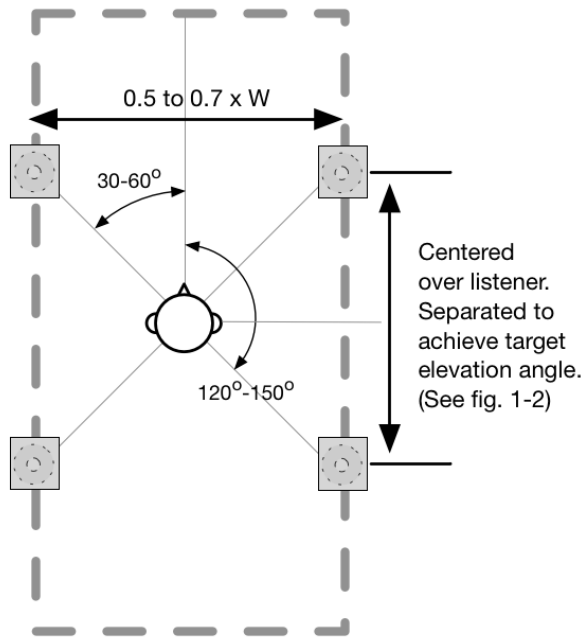

Figure 4: Top view, height (overhead) speaker positioning.

Room treatment considerations for use of overhead speakers

To improve sound quality and reduce unwanted audio reflection, we recommend using sound-absorbing and sound-diffusing treatment to handle reflections from the walls, floor, and ceiling.

Use of Existing Overhead Speakers

In some existing home theater systems, overhead speakers are employed to generate audio that would otherwise be created by listener-level speakers (for example, left/right surround speakers). When transitioning to Dolby Atmos, you should repurpose existing overhead speakers as overhead outputs only if you can add a corresponding listener-level speaker to assume the previous overhead speaker feed.

For example, if two overhead speakers located toward the rear of the room are currently used to reproduce left/right surround outputs, they should be used as overhead speakers only if replacement left/right surrounds can be added at the listener level. If this is not possible, the overhead speakers can continue to be used for left/right surround outputs, although not recommended.⁴ In this case, overhead sound can be achieved by installing additional overhead speakers, Dolby Atmos enabled speakers, or add-on modules in the front speaker locations.

⁴ To get the best Dolby Atmos experience, there must be separation between the listener-level speakers and overhead speakers. Installing all of the speakers in the ceiling will not give the optimal experience and is not recommended.

Alternatives to Overhead Speakers

Installing overhead speakers may not be possible or desirable, and running the necessary wiring can be expensive and time consuming. If you rent the home, the property owner may not allow the change. If the ceiling is made of a material such as concrete or brick, installing speakers overhead may not be possible. Finally, you may not like the look of overhead speakers.

Dolby Atmos Enabled Speakers

Through our knowledge of psychoacoustics and sound physics, we've developed technology that enables speakers to create overhead sound even though they're only a few feet off the floor. Dolby specifies the angle of incidence in the speaker cabinet, directivity, frequency response (including height-cue filtering), and other performance characteristics to ensure that the majority of acoustic energy is directed toward the ceiling, generating audio that the listener perceives as coming from overhead. All of these speaker characteristics work together to ensure that the re-creation of overhead sound is highly accurate and produces a lifelike height image. The performance of Dolby Atmos enabled speakers, whether integrated or add-on modules, must be experienced to be believed.

Integrated speakers

You can select integrated Dolby Atmos enabled speakers that include both traditional front-firing speakers and upward-firing speakers in a single speaker cabinet or in-wall configuration. (These speakers have two sets of speaker binding posts, one for the traditional speaker and one for the upward-firing Dolby Atmos enabled speaker.)⁵

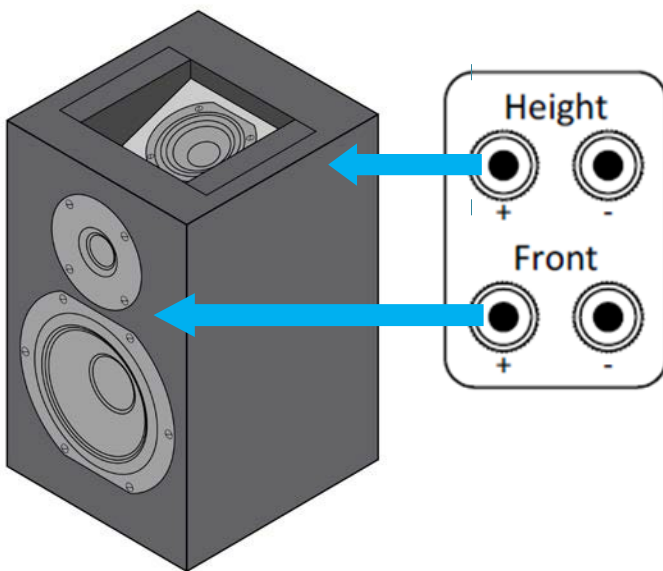

⁵ The height terminals of an integrated Dolby Atmos enabled speaker or an add-on module must be individually connected to the corresponding output terminals on the AVR via their own speaker wire pair. Bridging the height terminals with the main speaker terminals will result in an inaccurate audio experience, and the height audio will not be correctly produced.

Figure 5: Dolby Atmos enabled integrated speakers include both traditional front-firing speakers and upward-firing speakers. Both sets of speakers have their own binding posts to connect to your AVR.

Add-on modules

If you already have conventional speakers that you prefer to maintain, one option is to install Dolby Atmos enabled add-on speaker modules. These modules include only the upward-firing elements and can be in the form of a cabinet or in-wall speaker. You can place the add-on modules on top of the current speakers or nearby on or in another wall or surface.

Note: To ensure optimal performance, be sure to employ proper bass management when installing and calibrating Dolby Atmos enabled integrated speakers and add-on modules in your home theater system. Typically, these speakers are not full range. Please refer to the bass management subsection later in this section.

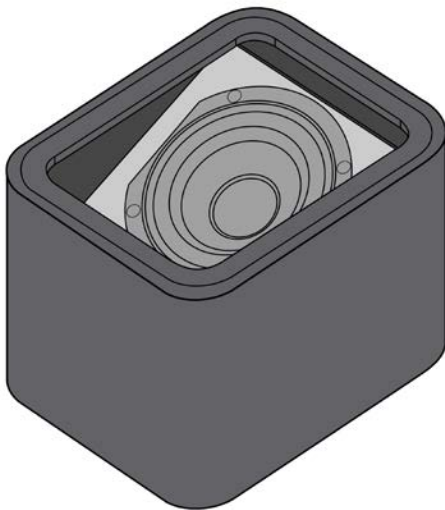

Figure 6: Dolby Atmos enabled add-on modules include only upward-firing elements. You can place them on top of your traditional front-firing speakers or on another surface near them.

Comparison to overhead speakers

Dolby Atmos enabled speakers produce a slightly more diffuse overhead audio experience that is quite lifelike and, in some cases, may be preferable to the sound that originates from overhead speakers. If the ceiling is low or you have to mount the speakers on overhead trusses or brackets, overhead speakers may be too close to you as you listen. The audio may be distracting because you'll hear and notice the output from each speaker instead of feeling immersed in an atmosphere in which sounds occur naturally overhead.

In this environment, Dolby Atmos enabled speakers may be a better solution for reproducing the height plane of sound, similar to what you would hear in a cinema. In a cinema, the overhead speakers are located high in the auditorium and naturally create a more diffuse experience. Using Dolby Atmos enabled speakers produces a similar experience: the reflection of sound off the ceiling makes the overhead effect sound diffuse, which results in the room sounding larger. Audio mixers and experts who have auditioned Dolby Atmos enabled speakers agree that the sound these speakers produce can be preferable to the sound of dedicated overhead speakers.

Dolby Atmos enabled speaker positioning

We recommend installing four Dolby Atmos enabled speakers whenever possible. The use of four speakers will make the placement of overhead sounds more accurate, and you'll get more precise, realistic sounds when an object, such as a helicopter, passes overhead. Two of the Dolby Atmos enabled speakers (whether they are integrated speakers or add-on modules) should be placed in the left front and right front speaker locations of your system. The other two should be positioned ideally in the rear surround speaker locations or alternatively in the surround sound speaker locations.

If you are using only two Dolby Atmos enabled speakers, place them at the left front and right front speaker locations.

Note: With the exception of the center and center surround speakers, all speakers in a Dolby Atmos playback system (listener level, overhead, and Dolby Atmos enabled) must be added in pairs.

Placement height

For optimal effect and to minimize direct radiating audio at listener level, place Dolby Atmos enabled speakers at or slightly above the height of your ears when seated. Avoid placing the Dolby Atmos enabled speakers higher than one-half the height of your wall.

Note: For some Dolby Atmos enabled in-wall speakers, if the placement is above one-half the height of your wall, you may need to adjust the vertical angle, if the manufacturer implements this feature. Please consult the manufacturer's user manual for guidance.

Placement relative to listeners

To avoid an unwanted proximity effect, make sure the speakers are at least 3 feet (0.9 meter) away from listening positions, ideally 5 feet (1.5 meters) or more. This distance may be less than 5 feet if the upward-firing driver(s) of the Dolby Atmos enabled speaker is placed well above the level of the closest listener's head.

Positioning of add-on modules

If you're using add-on modules, place them either on top of the front and surround (ideally, rear surround) speakers or within 3 feet (0.9 meter) of those speakers. Place on-wall or in-wall add-on modules in the same position. Dolby Atmos enabled speakers should be mounted so that the driver is facing toward the ceiling.

Combination: Overhead and Dolby Atmos enabled speakers

In some instances, a home theater system may already have overhead speakers that can be used to generate overhead audio. In this case, Dolby Atmos enabled speakers may be used to complement existing overhead speakers to create a full four-speaker height experience. If existing overhead speakers are in the front of the room, then Dolby Atmos enabled speakers may be used in the rear of the room, and vice versa.

Room treatment considerations for use of Dolby Atmos enabled speakers

For optimal performance, the ceiling should be flat (not angled or vaulted), with a height between 7.5 and 14 feet (2.3 to 4.3 meters), and made of an acoustically reflective material (drywall, plaster, hardwood, or another rigid, non-sound-absorbing material). The ideal ceiling height is between 7.5 and 12 feet (2.3 to 3.66 meters).

To improve sound quality and system performance, we recommend using sound-absorbing and sound-diffusing treatment to reduce unwanted reflections from the walls and floor. When using Dolby Atmos enabled speakers, first audio reflection from the ceiling is desired; audio reflections from elsewhere within the room should be avoided.

Note: If your room has acoustic ceiling tiles, replace the tiles where the reflection from the Dolby Atmos enabled speakers will occur with foam-core board or other reflective material.

Front height mounted speakers

Most AVRs will support the use of front height (Dolby® Pro Logic® IIz) mounted speakers with Dolby Atmos playback; however, we recommend the use of either overhead or Dolby Atmos enabled speakers to create the most lifelike and enveloping audio experience. Front height speakers may be used in conjunction with overhead speakers in larger room installations that can support a greater number of overhead/height outputs.

AVR connection and setup

Speaker connections

Most AVRs that support Dolby Atmos have speaker connections labeled HEIGHT, as shown in Figure 7. Some AVRs do not use the HEIGHT label for all capable channels, but they instead allow you to assign specific terminals for the height speaker outputs through the graphical user interface in the setup menu. Connect overhead speakers or Dolby Atmos enabled speakers to those height-capable outputs.⁶



Figure 7: Rear panel of AVR; the height speaker connections are at right.

If you're using four overhead or Dolby Atmos enabled speakers (or think you might add these in the future), you will need an AVR capable of four height outputs.

Most AVRs will require the user to set up the AVR through the user interface, or microphone detection, in order to properly set the speaker type and speaker locations in the room playback configuration. Be sure to complete this step so that Dolby Atmos audio objects are accurately placed using the available speakers.

Bass management

Bass management settings should be set correctly to correspond to the speaker capabilities in the system. A Dolby Atmos playback system may consist of dedicated overhead speakers, Dolby Atmos enabled speakers, or a combination. Be sure to keep in mind the low-frequency extension of each speaker in the layout when calibrating and setting up bass management. Be mindful to employ proper bass management when installing Dolby Atmos enabled speakers in the system. These speakers are not full range, so please consult the manufacturer's documentation for specific details on each model.

⁶ The height terminals of an integrated Dolby Atmos enabled speaker or an add-on module must be individually connected to the corresponding output terminals on the AVR via their own speaker wire pair. Bridging the height terminals with the main speaker terminals will result in an inaccurate audio experience, and the height audio will not be correctly produced.

Setting distance

It is important to properly set the distance for all speakers to ensure that audio signals arrive at the listening position at the right time. The distance can be set manually or with the automatic calibration system that is included with almost all AVRs or processors. When manually setting the distance for Dolby Atmos enabled speakers, make sure to include the distance from both (a) the speaker to the ceiling and (b) the ceiling to the listening position. Autocalibration systems can sometimes incorrectly set the distance for Dolby Atmos enabled speakers, so make sure to double-check the settings in the speaker setup menu if you run autocalibration.

Speaker-Level Calibration and EQ

You should perform standard calibration (EQ, levels, and delay) on Dolby Atmos playback systems, just as you would with traditional systems. Most home AVR systems feature autocalibration technologies that handle level setting, delays, and frequency response correction adequately for the home theater. However, such systems are not perfect, and we recommend that you or a professional home theater installer combine a manual calibration sweep with skilled listening and adjustment of the system's responses to ensure accurate reproduction capability and consistency of channel-to-channel timbre.

Manual calibration

Each full-range speaker should be calibrated to produce the same C-weighted sound pressure level (SPL). The target SPL can range from 79 dB to 82 dB SPL(C) at the central listening position, depending on the room size, when driven with pink noise with an RMS level of ---20 decibels relative to full scale (dBFS).

Calibrate the subwoofer level to give the same level for redirected bass content from full-range speakers as those speakers produce in their pass bands. The target SPL can range from 79 dB to 82 dB SPL(C) at the central listening position, depending on the room size.

Note: If you use the autocalibration setup included in your AVR or processor, be sure to manually check the levels on the subwoofer and the Dolby Atmos enabled speakers. Some home theater systems do not correctly set the levels for these speakers.

3. Standard Speaker Configurations

Dolby Conventions for Speaker Configurations

With the debut of Dolby Atmos, there is a new method of referring to surround sound speaker configurations (see the “Dolby Atmos for the Home Theater” white paper for more details). As we mentioned earlier, it is based on the standard nomenclature (stereo, 5.1, and 7.1) but adds a number at the end to specify the number of height speakers in the playback system (for example, 7.1.4).

While manufacturers may decide to support more than one subwoofer output, Dolby Atmos technology generates a single Low-Frequency Effects (LFE) signal. Figures 8, 9, and 10 show the most common speaker layouts in a Dolby Atmos home theater system.

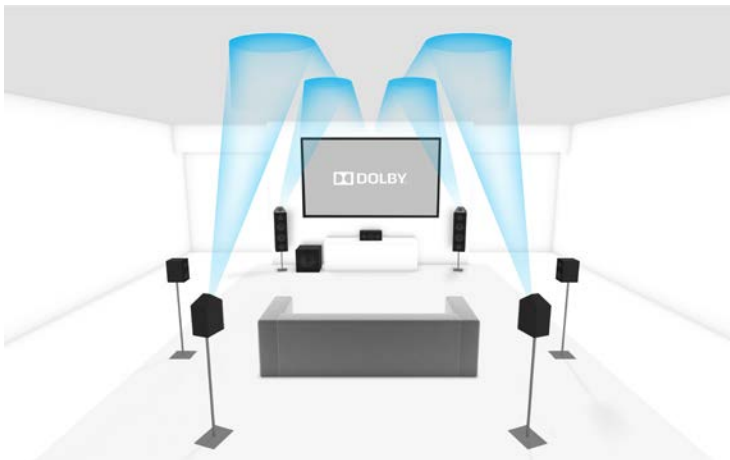

Figure 8: A traditional 7.1 speaker layout with four Dolby Atmos enabled speakers (7.1.4).



Figure 9: A traditional 5.1 speaker layout with four overhead speakers (5.1.4).



Figure 10: A traditional 5.1 speaker layout with two Dolby Atmos enabled speakers (5.1.2).

Standard Setups for Both Overhead Speakers and Dolby Atmos Enabled Speakers

The following pages contain images of standard and hybrid setups for the most common speaker configurations and are provided for both virtual, overhead and Dolby Atmos enabled speakers.



Home Theater Speaker Guide

Optimize your sound system that includes Dolby Atmos® technology with this step-by-step guide to the best speaker setup.

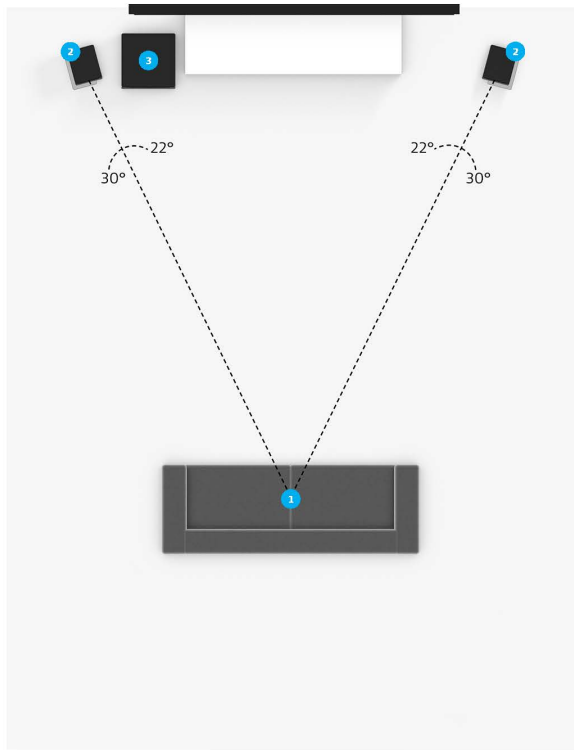

Speaker placement for 2.1 setup

2.1 Virtual Speakers

- 1. Seating position
- 2. Left and right speakers
- 3. Subwoofer

Dolby Atmos speaker setups: What do these numbers mean?

When shopping for Dolby Atmos home theater components, you'll see a new way of describing speaker configurations.

2.1

This refers to the number of traditional surround speakers (front, center, surround, etc.)

This number refers to how many powered subwoofers you can connect to your receiver.



Perspective detail for 2.1 setup

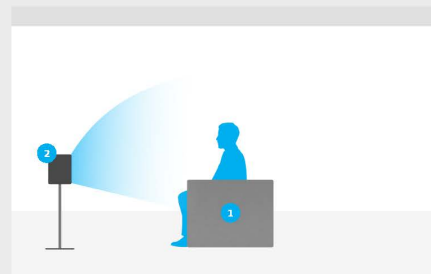

Virtual speaker placement: detail for 2.1 setup



Home Theater Speaker Guide

Optimize your sound system that includes Dolby Atmos® technology with this step-by-step guide to the best speaker setup.

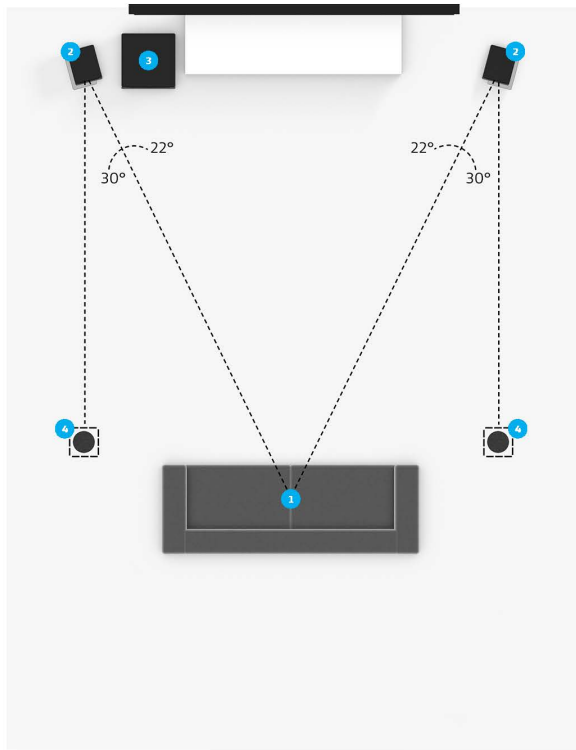

Speaker placement for 2.1.2 setup

2.1.2 Overhead Speakers

1. Seating position
2. Left and right speakers
3. Subwoofer
4. Left and right top middle overhead speakers

Dolby Atmos speaker setups: What do these numbers mean?

When shopping for Dolby Atmos home theater components, you'll see a new way of describing speaker configurations.

2.1.2

This refers to the number of traditional surround speakers (front, center, surround, etc.)

This number refers to how many powered subwoofers you can connect to your receiver.

This refers to how many overhead or Dolby Atmos enabled speakers you can use in your Dolby Atmos capable setup.



Perspective detail for 2.1.2 setup

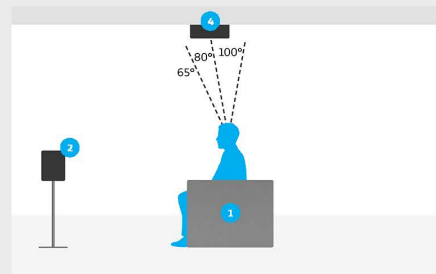

Overhead speaker placement detail for 2.1.2 setup



Home Theater Speaker Guide

Optimize your sound system that includes Dolby Atmos® technology with this step-by-step guide to the best speaker setup.

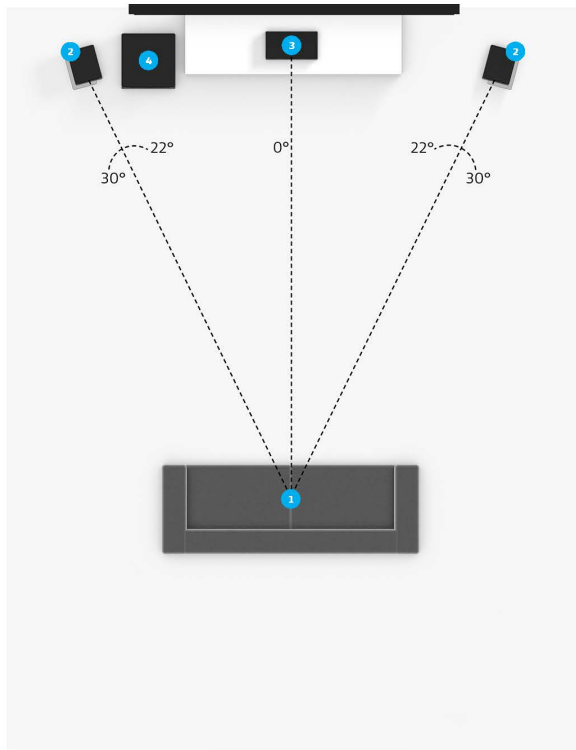

Speaker placement for 3.1 setup

3.1 Virtual Speakers

- 1. Seating position
- 2. Left and right speakers
- 3. Center speaker
- 4. Subwoofer

Dolby Atmos speaker setups: What do these numbers mean?

When shopping for Dolby Atmos home theater components, you'll see a new way of describing speaker configurations.

3.1

This refers to the number of traditional surround speakers (front, center, surround, etc.)

This number refers to how many powered subwoofers you can connect to your receiver.

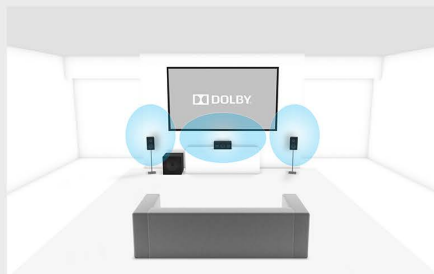

Perspective detail for 3.1 setup

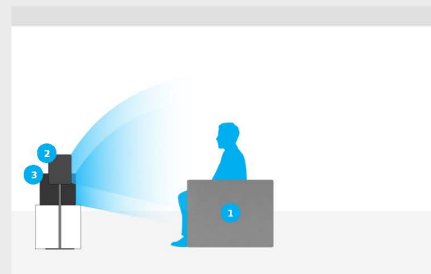

Virtual speaker placement: detail for 3.1 setup



Home Theater Speaker Guide

Optimize your sound system that includes Dolby Atmos® technology with this step-by-step guide to the best speaker setup.

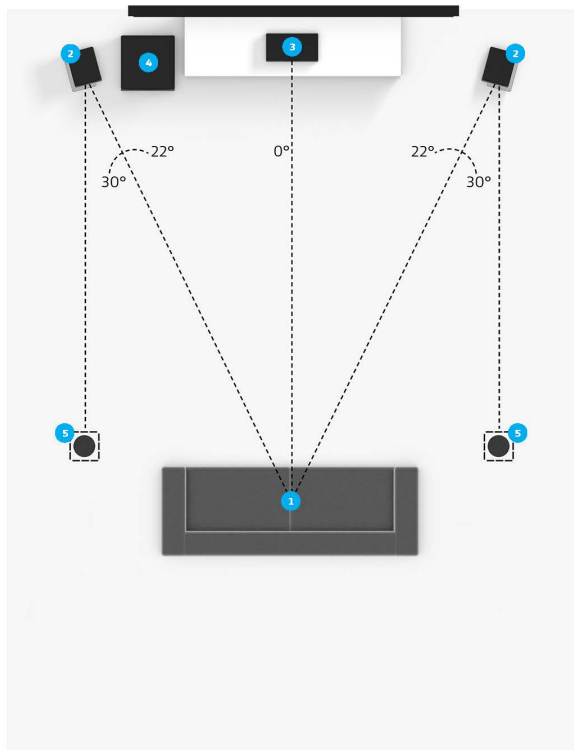

Speaker placement for 3.1.2 setup

3.1.2 Overhead Speakers

1. Seating position
2. Left and right speakers
3. Center speaker
4. Subwoofer
5. Left and right top middle overhead speakers

Dolby Atmos speaker setups: What do these numbers mean?

When shopping for Dolby Atmos home theater components, you'll see a new way of describing speaker configurations.

3.1.2

This refers to the number of traditional surround speakers (front, center, surround, etc.)

This number refers to how many powered subwoofers you can connect to your receiver.

This refers to how many overhead or Dolby Atmos enabled speakers you can use in your Dolby Atmos capable setup.



Perspective detail for 3.1.2 setup

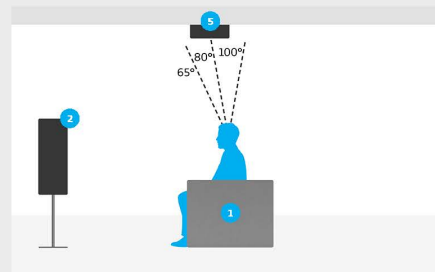

Overhead speaker placement detail for 3.1.2 setup



Home Theater Speaker Guide

Optimize your sound system that includes Dolby Atmos® technology with this step-by-step guide to the best speaker setup.

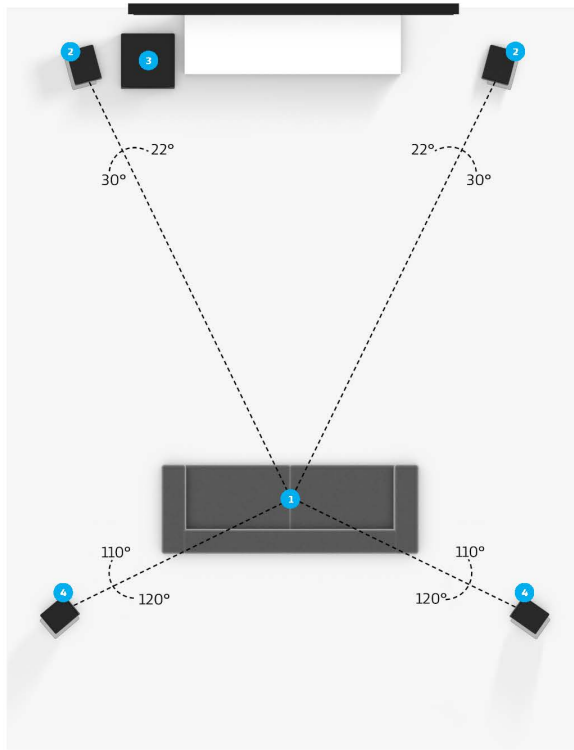

Speaker placement for 4.1 setup

4.1 Virtual Speakers

- 1. Seating position
- 2. Left and right speakers
- 3. Subwoofer
- 4. Left and right surround speakers

Dolby Atmos speaker setups: What do these numbers mean?

When shopping for Dolby Atmos home theater components, you'll see a new way of describing speaker configurations.

4.1

This refers to the number of traditional surround speakers (front, center, surround, etc.)

This number refers to how many powered subwoofers you can connect to your receiver.



Perspective detail for 4.1 setup

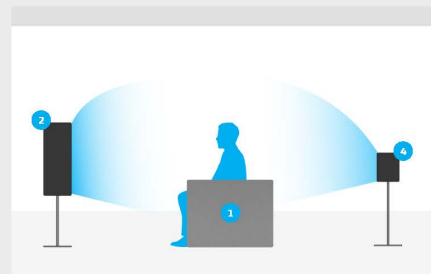

Virtual speaker placement: detail for 4.1 setup



Home Theater Speaker Guide

Optimize your sound system that includes Dolby Atmos® technology with this step-by-step guide to the best speaker setup.

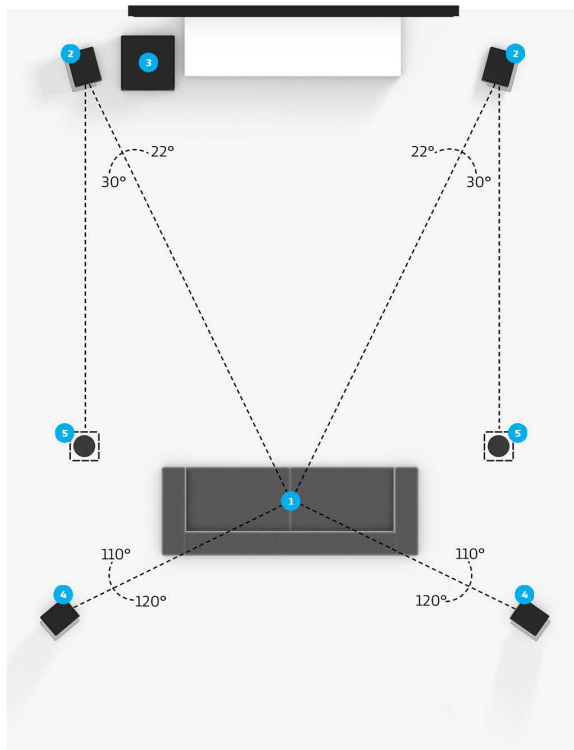

Speaker placement for 4.1.2 setup

4.1.2 Overhead Speakers

- 1. Seating position
- 2. Left and right speakers
- 3. Subwoofer
- 4. Left and right surround speakers
- 5. Left and right top middle overhead speakers

Dolby Atmos speaker setups: What do these numbers mean?

When shopping for Dolby Atmos home theater components, you'll see a new way of describing speaker configurations.

4.1.2

This refers to the number of traditional surround speakers (front, center, surround, etc.)

This number refers to how many powered subwoofers you can connect to your receiver.

This refers to how many overhead or Dolby Atmos enabled speakers you can use in your Dolby Atmos capable setup.



Perspective detail for 4.1.2 setup

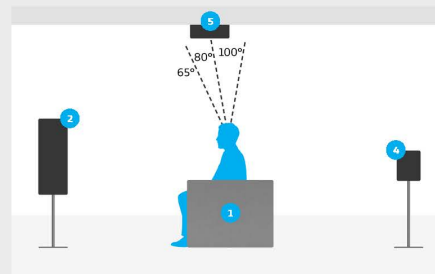

Overhead speaker placement detail for 4.1.2 setup



Home Theater Speaker Guide

Optimize your sound system that includes Dolby Atmos® technology with this step-by-step guide to the best speaker setup.

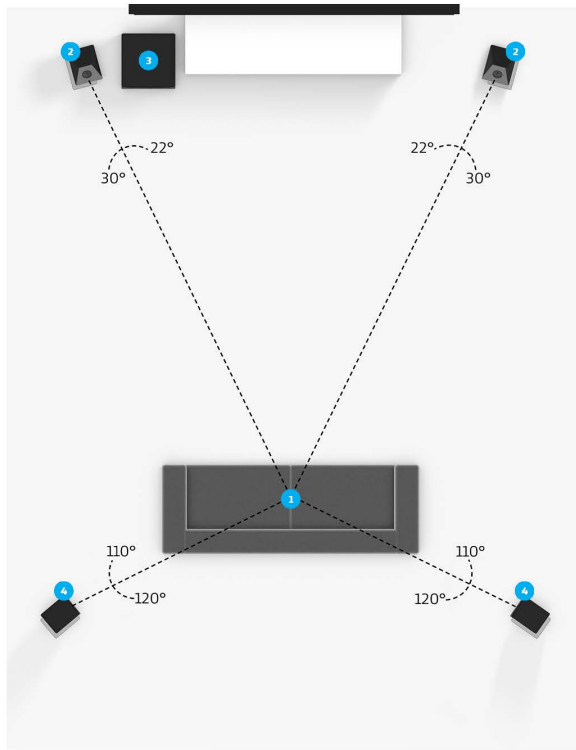

Speaker placement for 4.1.2 setup

4.1.2 Dolby Atmos Enabled Speakers

1. Seating position
2. Left and right Dolby Atmos enabled speakers
3. Subwoofer
4. Left and right surround speakers

Dolby Atmos speaker setups:

What do these numbers mean?

When shopping for Dolby Atmos home theater components, you'll see a new way of describing speaker configurations.

4.1.2

This refers to the number of traditional surround speakers (front, center, surround, etc.)

This number refers to how many powered subwoofers you can connect to your receiver.

This refers to how many overhead or Dolby Atmos enabled speakers you can use in your Dolby Atmos capable setup.



Perspective detail for 4.1.2 setup



Home Theater Speaker Guide

Optimize your sound system that includes Dolby Atmos® technology with this step-by-step guide to the best speaker setup.

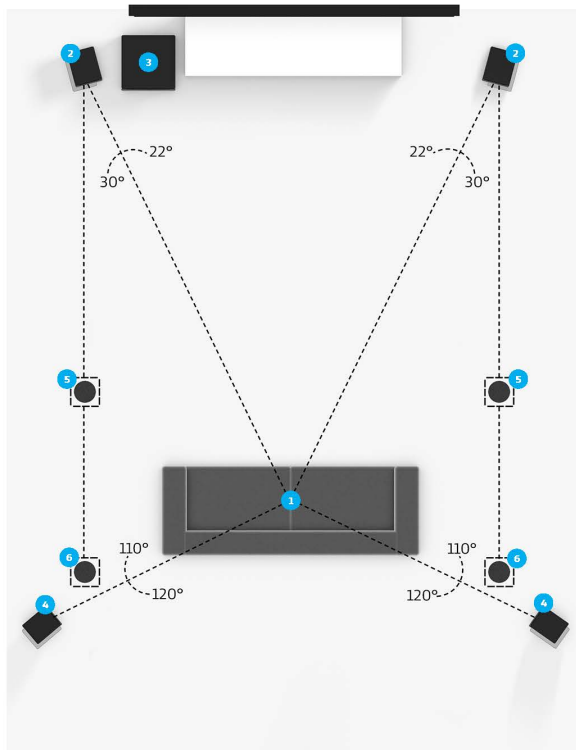

Speaker placement for 4.1.4 setup

4.1.4 Overhead Speakers

- 1. Seating position
- 2. Left and right speakers
- 3. Subwoofer
- 4. Left and right surround speakers
- 5. Left and right top front overhead speakers
- 6. Left and right top rear overhead speakers

Dolby Atmos speaker setups: What do these numbers mean?

When shopping for Dolby Atmos home theater components, you'll see a new way of describing speaker configurations.

4.1.4

This refers to the number of traditional surround speakers (front, center, surround, etc.)

This number refers to how many powered subwoofers you can connect to your receiver.

This refers to how many overhead or Dolby Atmos enabled speakers you can use in your Dolby Atmos capable setup.



Perspective detail for 4.1.4 setup

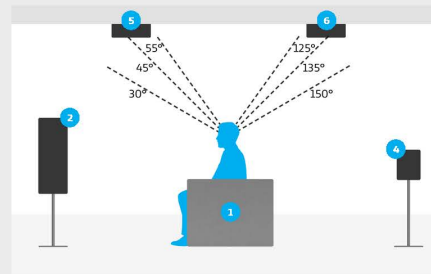

Overhead speaker placement detail for 4.1.4 setup



Home Theater Speaker Guide

Optimize your sound system that includes Dolby Atmos® technology with this step-by-step guide to the best speaker setup.

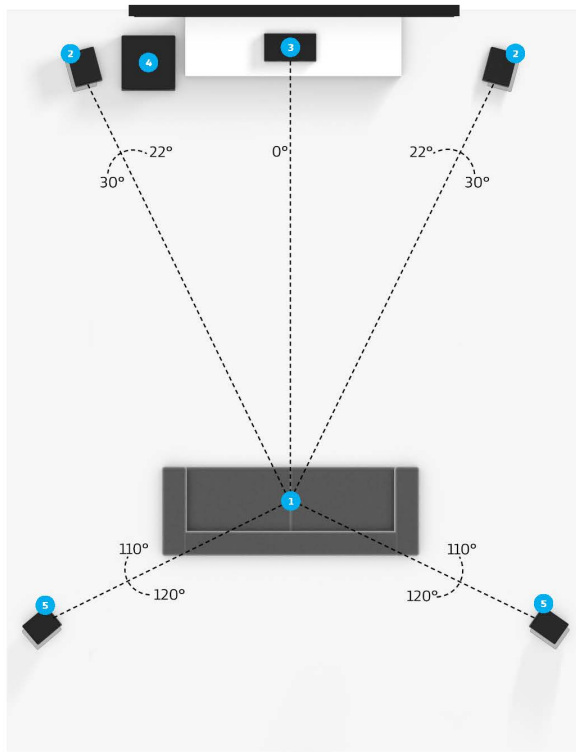

Speaker placement for 5.1 setup

5.1 Virtual Speakers

- 1. Seating position
- 2. Left and right speakers
- 3. Center speaker
- 4. Subwoofer
- 5. Left and right surround speakers

Dolby Atmos speaker setups: What do these numbers mean?

When shopping for Dolby Atmos home theater components, you'll see a new way of describing speaker configurations.

5.1

This refers to the number of traditional surround speakers (front, center, surround, etc.)

This number refers to how many powered subwoofers you can connect to your receiver.



Perspective detail for 5.1 setup

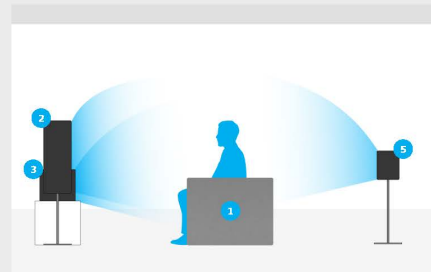

Virtual speaker placement: detail for 5.1 setup



Home Theater Speaker Guide

Optimize your sound system that includes Dolby Atmos® technology with this step-by-step guide to the best speaker setup.

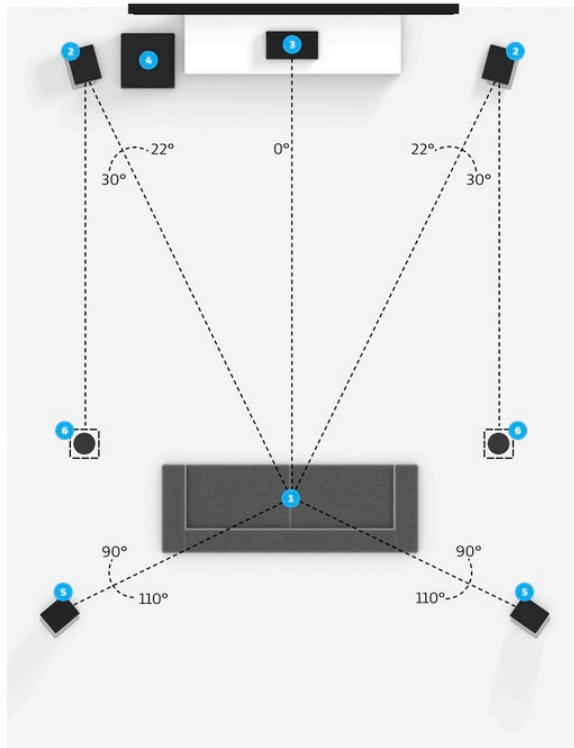

Speaker placement for 5.1.2 setup

5.1.2 Overhead Speakers

1. Seating position
2. Left and right speakers
3. Center speaker
4. Subwoofer
5. Left and right surround speakers
6. Left and right top middle overhead speakers

Dolby Atmos speaker setups: What do these numbers mean?

When shopping for Dolby Atmos home theater components, you'll see a new way of describing speaker configurations.

5.1.2

This refers to the number of traditional surround speakers (front, center, surround, etc.)

This number refers to how many powered subwoofers you can connect to your receiver.

This refers to how many overhead or Dolby Atmos enabled speakers you can use in your Dolby Atmos capable setup.



Perspective detail for 5.1.2 setup

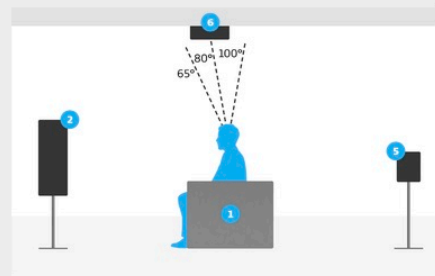

Overhead speaker placement detail for 5.1.2 setup

Figure 11: Standard 5.1.2 setup with overhead speakers.



Home Theater Speaker Guide

Optimize your sound system that includes Dolby Atmos® technology with this step-by-step guide to the best speaker setup.

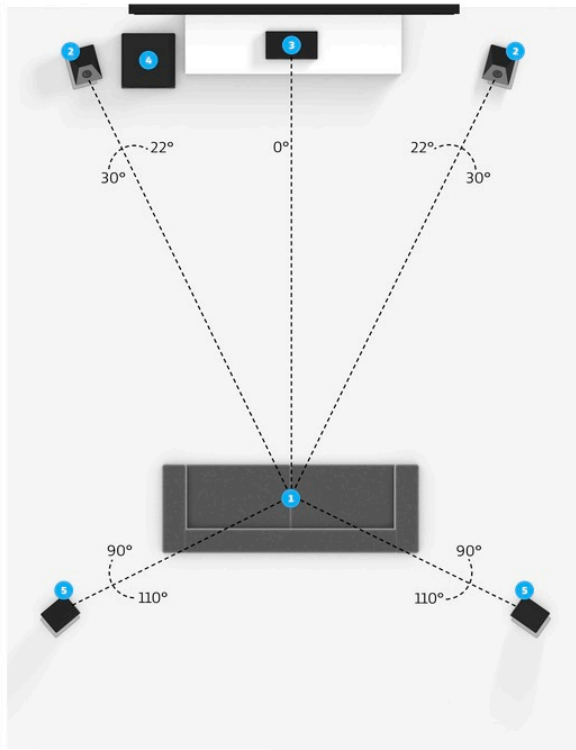

Speaker placement for 5.1.2 setup

5.1.2 Dolby Atmos Enabled Speakers

1. Seating position
2. Left and right Dolby Atmos enabled speakers
3. Center speaker
4. Subwoofer
5. Left and right surround speakers

Dolby Atmos speaker setups:

What do these numbers mean?

When shopping for Dolby Atmos home theater components, you'll see a new way of describing speaker configurations.

5.1.2

This refers to the number of traditional surround speakers (front, center, surround, etc.)

This number refers to how many powered subwoofers you can connect to your receiver.

This refers to how many overhead or Dolby Atmos enabled speakers you can use in your Dolby Atmos capable setup.



Perspective detail for 5.1.2 setup

Figure 12: Standard 5.1.2 setup with Dolby Atmos enabled speakers.



Home Theater Speaker Guide

Optimize your sound system that includes Dolby Atmos® technology with this step-by-step guide to the best speaker setup.

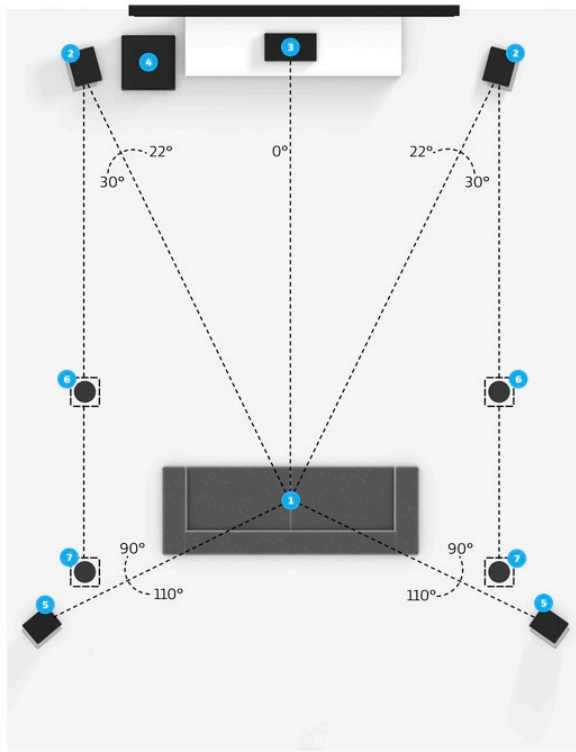

Speaker placement for 5.1.4 setup

5.1.4 Overhead Speakers

1. Seating position
2. Left and right speakers
3. Center speaker
4. Subwoofer
5. Left and right surround speakers
6. Left and right top front overhead speakers
7. Left and right top rear overhead speakers

Dolby Atmos speaker setups:

What do these numbers mean?

When shopping for Dolby Atmos home theater components, you'll see a new way of describing speaker configurations.

5.1.4

This refers to the number of traditional surround speakers (front, center, surround, etc.)

This number refers to how many powered subwoofers you can connect to your receiver.

This refers to how many overhead or Dolby Atmos enabled speakers you can use in your Dolby Atmos capable setup.



Perspective detail for 5.1.4 setup

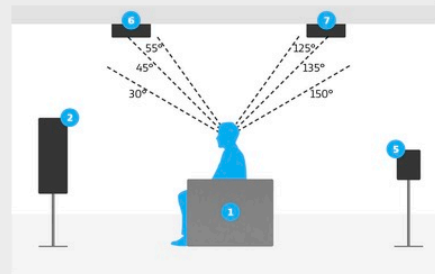

Overhead speaker placement detail for 5.1.4 setup

Figure 13: Standard 5.1.4 setup with overhead speakers.



Home Theater Speaker Guide

Optimize your sound system that includes Dolby Atmos® technology with this step-by-step guide to the best speaker setup.

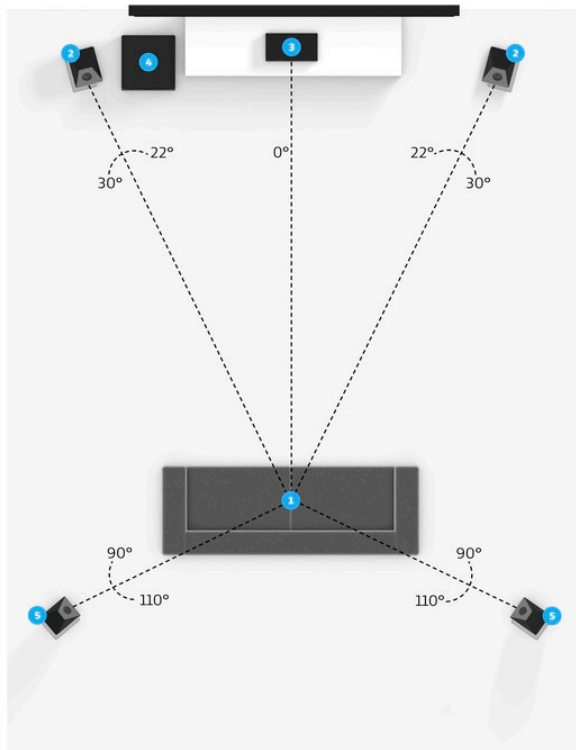

Speaker placement for 5.1.4 setup

5.1.4 Dolby Atmos Enabled Speakers

1. Seating position
2. Left and right front Dolby Atmos enabled speakers
3. Center speaker
4. Subwoofer
5. Left and right rear Dolby Atmos enabled surround speakers

Dolby Atmos speaker setups: What do these numbers mean?

When shopping for Dolby Atmos home theater components, you'll see a new way of describing speaker configurations.

5.1.4

This refers to the number of traditional surround speakers (front, center, surround, etc.)

This number refers to how many powered subwoofers you can connect to your receiver.

This refers to how many overhead or Dolby Atmos enabled speakers you can use in your Dolby Atmos capable setup.



Perspective detail for 5.1.4 setup

Figure 14: Standard 5.1.4 setup with Dolby Atmos enabled speakers.



Home Theater Speaker Guide

Optimize your sound system that includes Dolby Atmos® technology with this step-by-step guide to the best speaker setup.

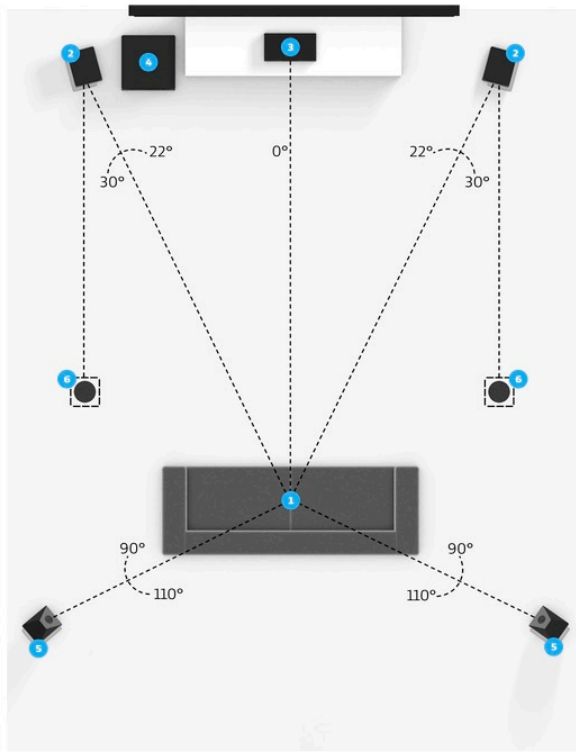

Speaker placement for 5.1.4 hybrid setup

5.1.4 Hybrid Overhead / Dolby Atmos Enabled Speakers

1. Seating position
2. Left and right speakers
3. Center speaker
4. Subwoofer
5. Left and right rear Dolby Atmos enabled speakers
6. Left and right top front overhead speakers

Dolby Atmos speaker setups: What do these numbers mean?

When shopping for Dolby Atmos home theater components, you'll see a new way of describing speaker configurations.

5.1.4

This refers to the number of traditional surround speakers (front, center, surround, etc.)

This number refers to how many powered subwoofers you can connect to your receiver.

This refers to how many overhead or Dolby Atmos enabled speakers you can use in your Dolby Atmos capable setup.



Perspective detail for 5.1.4 hybrid setup

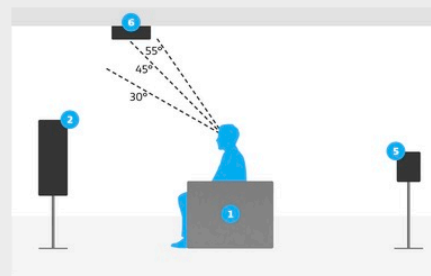

Overhead speaker placement detail for 5.1.4 hybrid setup

Figure 15: Hybrid 5.1.4 setup with rear Dolby Atmos enabled speakers and front overhead speakers.



Home Theater Speaker Guide

Optimize your sound system that includes Dolby Atmos® technology with this step-by-step guide to the best speaker setup.

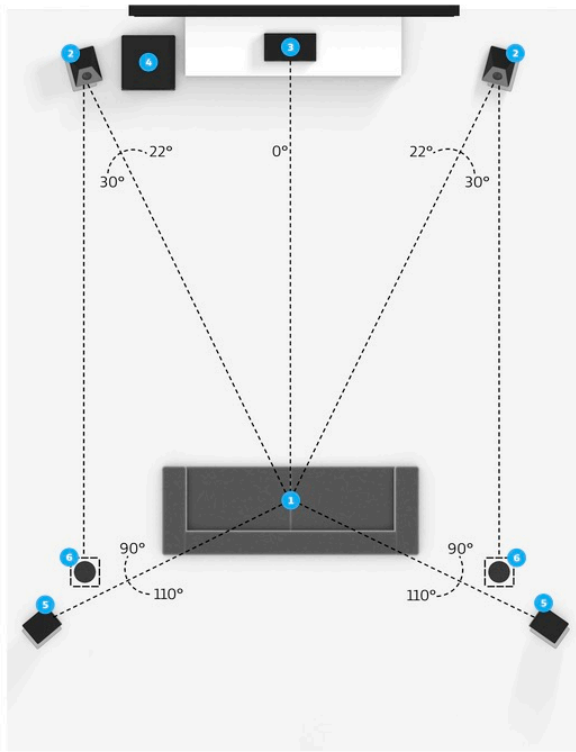

Speaker placement for 5.1.4 hybrid setup

5.1.4 Hybrid Dolby Atmos Enabled Speakers / Overhead

1. Seating position
2. Left and right front Dolby Atmos enabled speakers
3. Center speaker
4. Subwoofer
5. Left and right surround speakers
6. Left and right top rear overhead speakers

Dolby Atmos speaker setups: What do these numbers mean?

When shopping for Dolby Atmos home theater components, you'll see a new way of describing speaker configurations.

5.1.4

This refers to the number of traditional surround speakers (front, center, surround, etc.)

This number refers to how many powered subwoofers you can connect to your receiver.

This refers to how many overhead or Dolby Atmos enabled speakers you can use in your Dolby Atmos capable setup.



Perspective detail for 5.1.4 hybrid setup

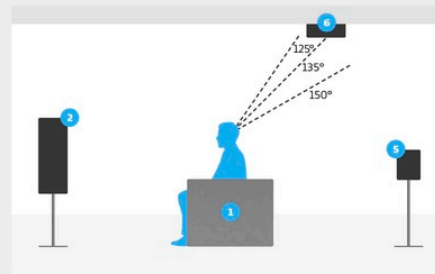

Overhead speaker placement detail for 5.1.4 hybrid setup

Figure 16: Hybrid 5.1.4 setup with front Dolby Atmos enabled speakers and rear overhead speakers.



Home Theater Speaker Guide

Optimize your sound system that includes Dolby Atmos® technology with this step-by-step guide to the best speaker setup.

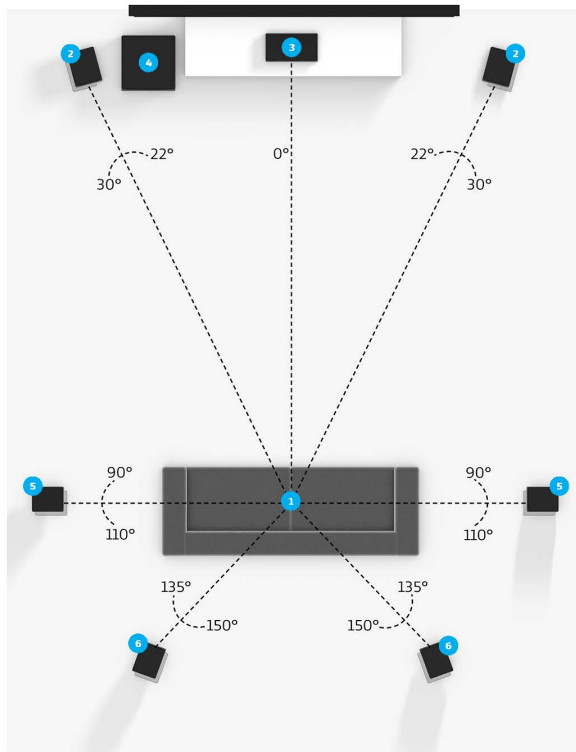

Speaker placement for 7.1 setup

7.1 Virtual Speakers

- 1. Seating position
- 2. Left and right speakers
- 3. Center speaker
- 4. Subwoofer
- 5. Left and right surround speakers
- 6. Left and right rear surround speakers

Dolby Atmos speaker setups: What do these numbers mean?

When shopping for Dolby Atmos home theater components, you'll see a new way of describing speaker configurations.

7.1

This refers to the number of traditional surround speakers (front, center, surround, etc.)

This number refers to how many powered subwoofers you can connect to your receiver.

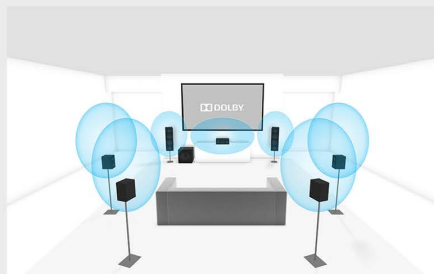

Perspective detail for 7.1 setup

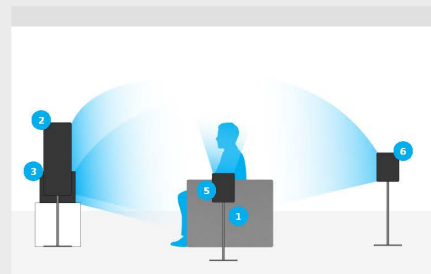

Virtual speaker placement: detail for 7.1 setup



Home Theater Speaker Guide

Optimize your sound system that includes Dolby Atmos® technology with this step-by-step guide to the best speaker setup.

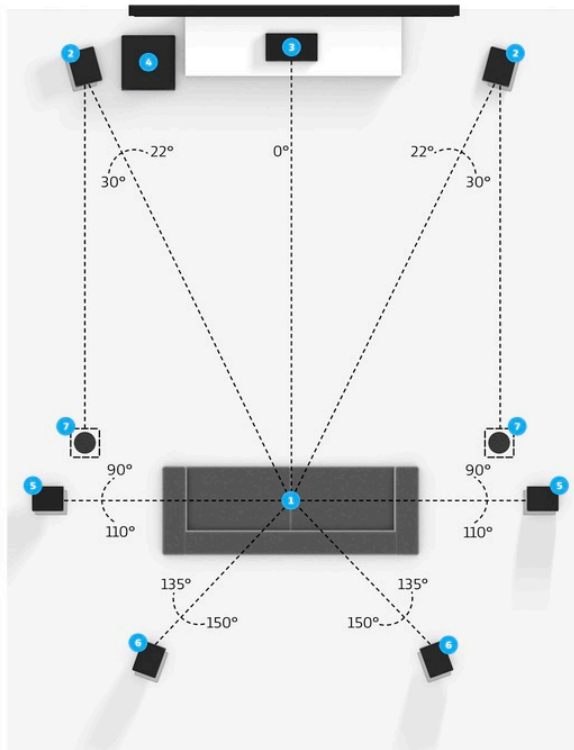

Speaker placement for 7.1.2 setup

7.1.2 Overhead Speakers

1. Seating position
2. Left and right speakers
3. Center speaker
4. Subwoofer
5. Left and right surround speakers
6. Left and right rear surround speakers
7. Left and right top middle overhead speakers

Dolby Atmos speaker setups: What do these numbers mean?

When shopping for Dolby Atmos home theater components, you'll see a new way of describing speaker configurations.

7.1.2

This refers to the number of traditional surround speakers (front, center, surround, etc.)

This number refers to how many powered subwoofers you can connect to your receiver.

This refers to how many overhead or Dolby Atmos enabled speakers you can use in your Dolby Atmos capable setup.



Perspective detail for 7.1.2 setup

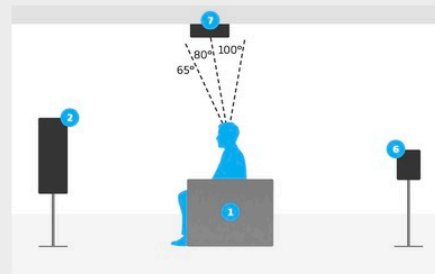

Overhead speaker placement detail for 7.1.2 setup

Figure 17: Standard 7.1.2 setup with overhead speakers.



Home Theater Speaker Guide

Optimize your sound system that includes Dolby Atmos® technology with this step-by-step guide to the best speaker setup.

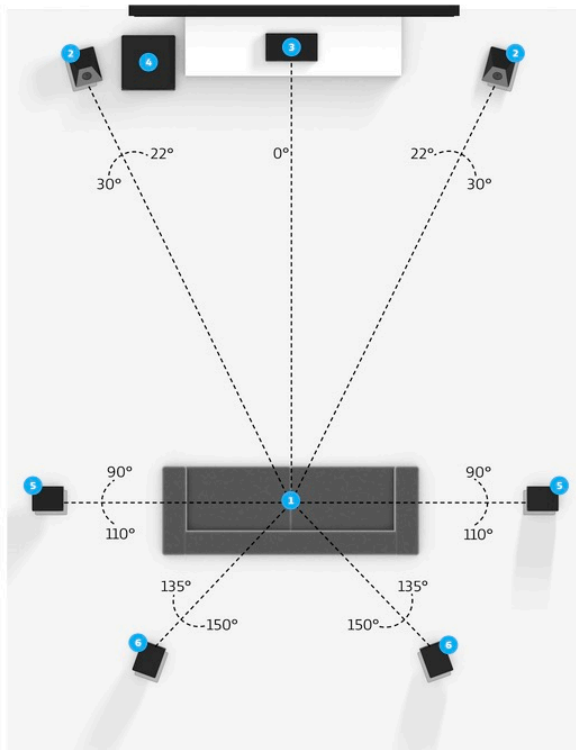

Speaker placement for 7.1.2 setup

7.1.2 Dolby Atmos Enabled Speakers

1. Seating position
2. Left and right Dolby Atmos enabled speakers
3. Center speaker
4. Subwoofer
5. Left and right surround speakers
6. Left and right rear surround speakers

Dolby Atmos speaker setups: What do these numbers mean?

When shopping for Dolby Atmos home theater components, you'll see a new way of describing speaker configurations.

7.1.2

This refers to the number of traditional surround speakers (front, center, surround, etc.)

This number refers to how many powered subwoofers you can connect to your receiver.

This refers to how many overhead or Dolby Atmos enabled speakers you can use in your Dolby Atmos capable setup.



Perspective detail for 7.1.2 setup

Figure 18: Standard 7.1.2 setup with Dolby Atmos enabled speakers.



Home Theater Speaker Guide

Optimize your sound system that includes Dolby Atmos® technology with this step-by-step guide to the best speaker setup.

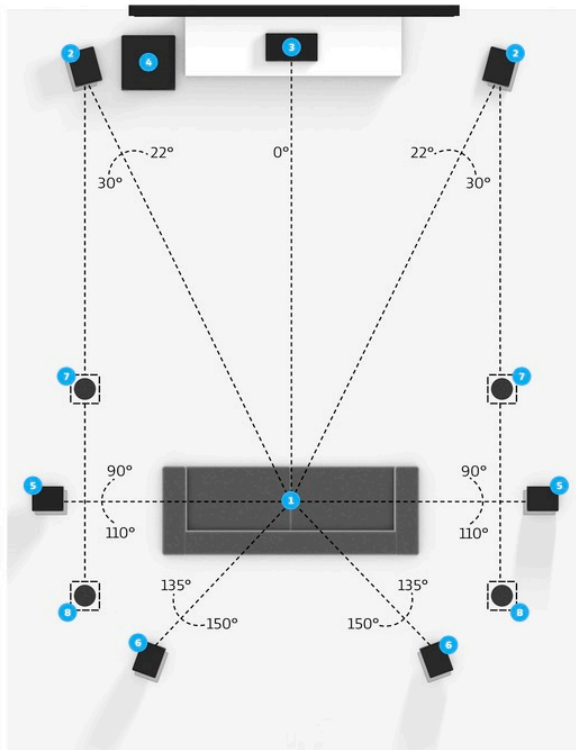

Speaker placement for 7.1.4 setup

7.1.4 Overhead Speakers

1. Seating position
2. Left and right speakers
3. Center speaker
4. Subwoofer
5. Left and right surround speakers
6. Left and right rear surround speakers
7. Left and right top front overhead speakers
8. Left and right top rear overhead speakers

Dolby Atmos speaker setups: What do these numbers mean?

When shopping for Dolby Atmos home theater components, you'll see a new way of describing speaker configurations.

7.1.4

This refers to the number of traditional surround speakers (front, center, surround, etc.)

This number refers to how many powered subwoofers you can connect to your receiver.

This refers to how many overhead or Dolby Atmos enabled speakers you can use in your Dolby Atmos capable setup.



Perspective detail for 7.1.4 setup

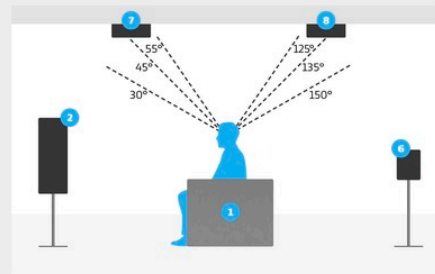

Overhead speaker placement detail for 7.1.4 setup

Figure 19: Standard 7.1.4 setup with overhead speakers.



Home Theater Speaker Guide

Optimize your sound system that includes Dolby Atmos® technology with this step-by-step guide to the best speaker setup.

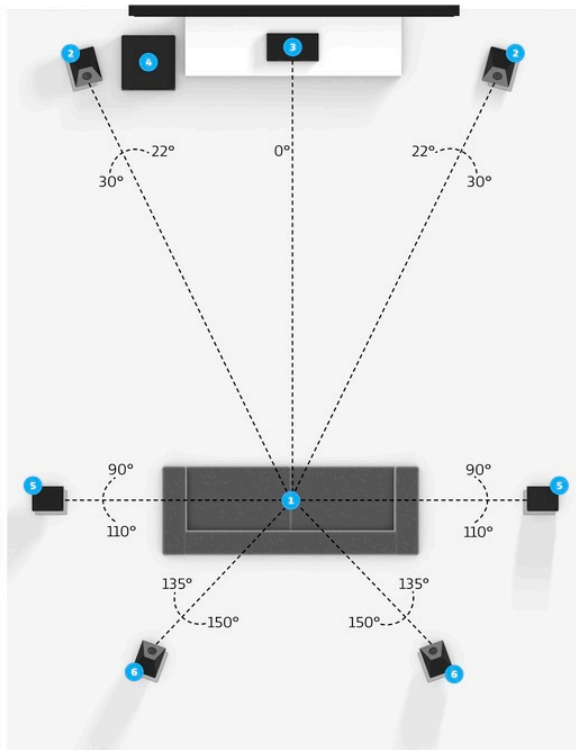

Speaker placement for 7.1.4 setup

7.1.4 Dolby Atmos Enabled Speakers

1. Seating position
2. Left and right front Dolby Atmos enabled speakers
3. Center speaker
4. Subwoofer
5. Left and right surround speakers
6. Left and right rear Dolby Atmos enabled surround speakers

Dolby Atmos speaker setups:

What do these numbers mean?

When shopping for Dolby Atmos home theater components, you'll see a new way of describing speaker configurations.

7.1.4

This refers to the number of traditional surround speakers (front, center, surround, etc.)

This number refers to how many powered subwoofers you can connect to your receiver.

This refers to how many overhead or Dolby Atmos enabled speakers you can use in your Dolby Atmos capable setup.



Perspective detail for 7.1.4 setup

Figure 20: Standard 7.1.4 setup with Dolby Atmos enabled speakers.



Home Theater Speaker Guide

Optimize your sound system that includes Dolby Atmos® technology with this step-by-step guide to the best speaker setup.

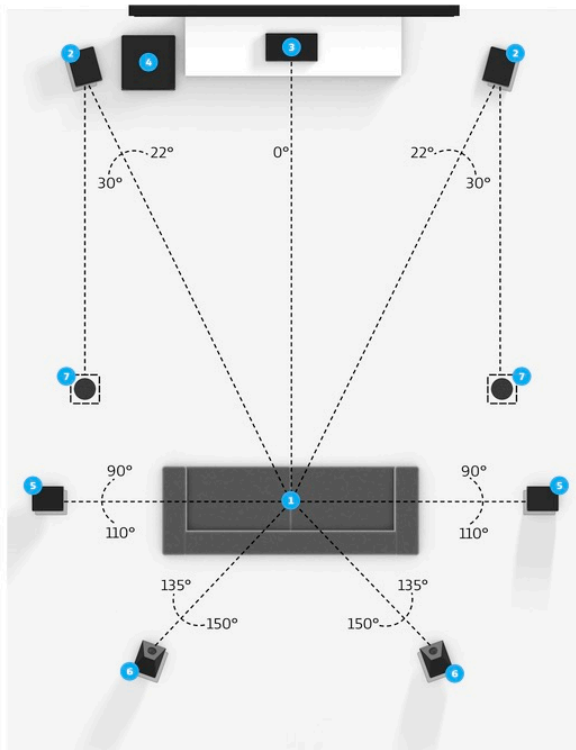

Speaker placement for 7.1.4 hybrid setup

7.1.4 Hybrid Overhead / Dolby Atmos Enabled Speakers

1. Seating position
2. Left and right speakers
3. Center speaker
4. Subwoofer
5. Left and right surround speakers
6. Left and right rear Dolby Atmos enabled speakers
7. Left and right top front overhead speakers

Dolby Atmos speaker setups:

What do these numbers mean?

When shopping for Dolby Atmos home theater components, you'll see a new way of describing speaker configurations.

7.1.4

This refers to the number of traditional surround speakers (front, center, surround, etc.)

This number refers to how many powered subwoofers you can connect to your receiver.

This refers to how many overhead or Dolby Atmos enabled speakers you can use in your Dolby Atmos capable setup.

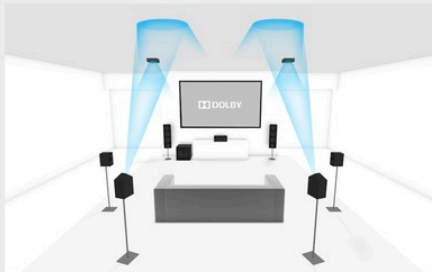

Perspective detail for 7.1.4 hybrid setup

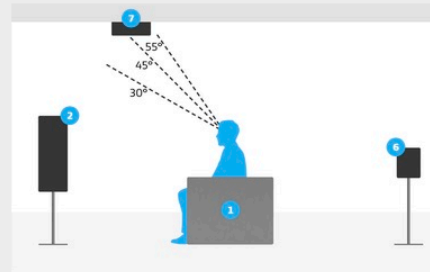

Overhead speaker placement detail for 7.1.4 hybrid setup

Figure 21: Hybrid 7.1.4 setup with rear Dolby Atmos enabled speakers and front overhead speakers.



Home Theater Speaker Guide

Optimize your sound system that includes Dolby Atmos® technology with this step-by-step guide to the best speaker setup.

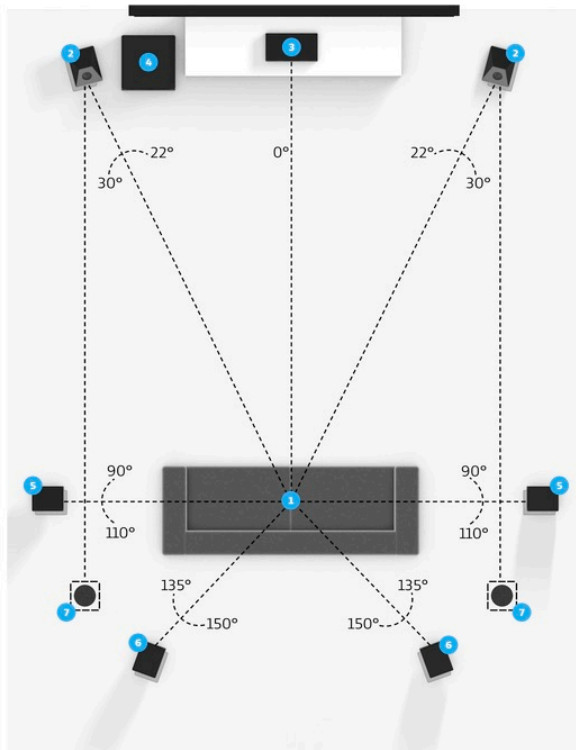

Speaker placement for 7.1.4 hybrid setup

7.1.4 Hybrid Dolby Atmos Enabled Speakers / Overhead

1. Seating position
2. Left and right front Dolby Atmos enabled speakers
3. Center speaker
4. Subwoofer
5. Left and right surround speakers
6. Left and right rear surround speakers
7. Left and right top rear overhead speakers

Dolby Atmos speaker setups: What do these numbers mean?

When shopping for Dolby Atmos home theater components, you'll see a new way of describing speaker configurations.

7.1.4

This refers to the number of traditional surround speakers (front, center, surround, etc.)

This number refers to how many powered subwoofers you can connect to your receiver.

This refers to how many overhead or Dolby Atmos enabled speakers you can use in your Dolby Atmos capable setup.



Perspective detail for 7.1.4 hybrid setup

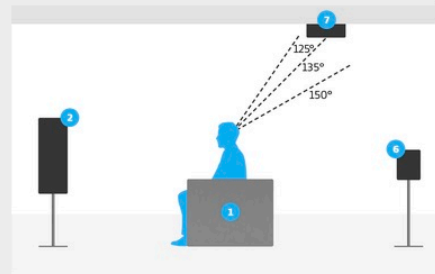

Overhead speaker placement detail for 7.1.4 hybrid setup

Figure 22: Hybrid 7.1.4 setup with front Dolby Atmos enabled speakers and rear overhead speakers.



Home Theater Speaker Guide

Optimize your sound system that includes Dolby Atmos® technology with this step-by-step guide to the best speaker setup.

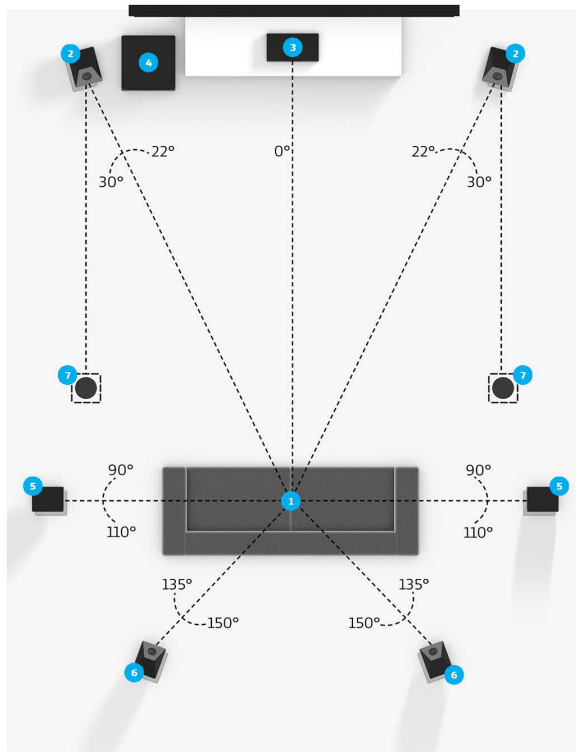

Speaker placement for 7.1.6 setup

7.1.6 Hybrid Dolby Atmos Enabled Speakers / Overhead

1. Seating position
2. Left and right front Dolby Atmos enabled speakers
3. Center speaker
4. Subwoofer
5. Left and right surround speakers
6. Left and right rear Dolby Atmos enabled surround speakers
7. Left and right top middle overhead speakers

Dolby Atmos speaker setups: What do these numbers mean?

When shopping for Dolby Atmos home theater components, you'll see a new way of describing speaker configurations.

7.1.6

This refers to the number of traditional surround speakers (front, center, surround, etc.)

This number refers to how many powered subwoofers you can connect to your receiver.

This refers to how many overhead or Dolby Atmos enabled speakers you can use in your Dolby Atmos capable setup.

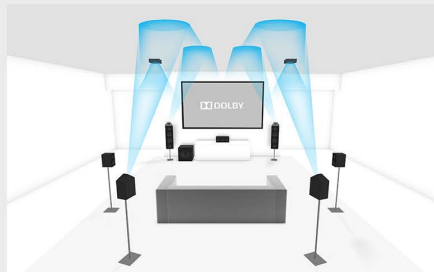

Perspective detail for 7.1.6 setup

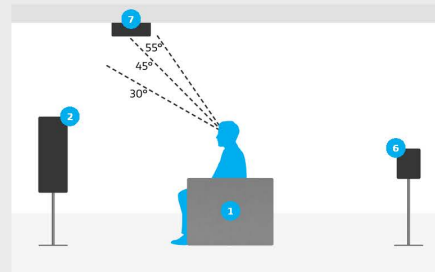

Overhead speaker placement detail for 7.1.6 hybrid setup



Home Theater Speaker Guide

Optimize your sound system that includes Dolby Atmos® technology with this step-by-step guide to the best speaker setup.

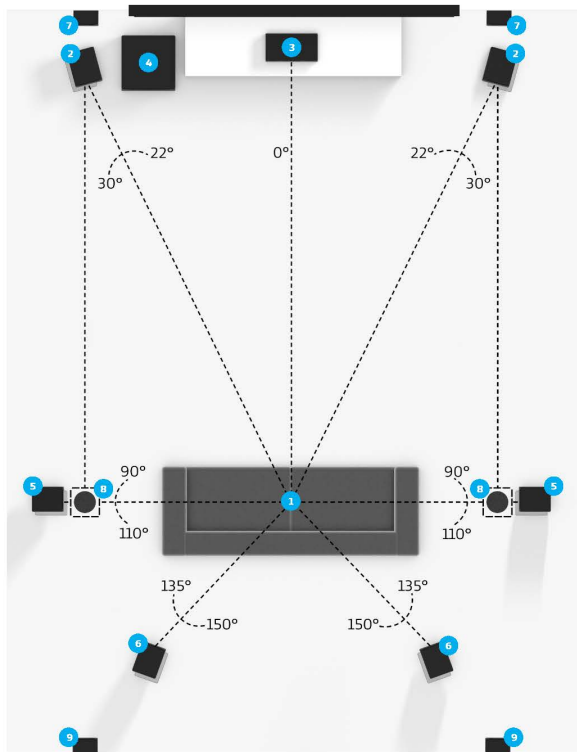

Speaker placement for 7.1.6 setup

7.1.6 Overhead Speakers

1. Seating position
2. Left and right speakers
3. Center speaker
4. Subwoofer
5. Left and right surround speakers
6. Left and right rear surround speakers
7. Left and right front height speakers
8. Left and right top middle overhead speakers
9. Left and right rear height speakers

Dolby Atmos speaker setups: What do these numbers mean?

When shopping for Dolby Atmos home theater components, you'll see a new way of describing speaker configurations.

7.1.6

This refers to the number of traditional surround speakers (front, center, surround, etc.)

This number refers to how many powered subwoofers you can connect to your receiver.

This refers to how many overhead or Dolby Atmos enabled speakers you can use in your Dolby Atmos capable setup.



Perspective detail for 7.1.6 setup

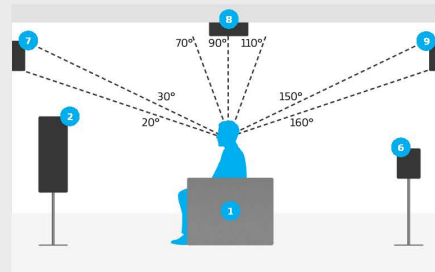

Overhead speaker placement detail for 7.1.6 setup



Home Theater Speaker Guide

Optimize your sound system that includes Dolby Atmos® technology with this step-by-step guide to the best speaker setup.

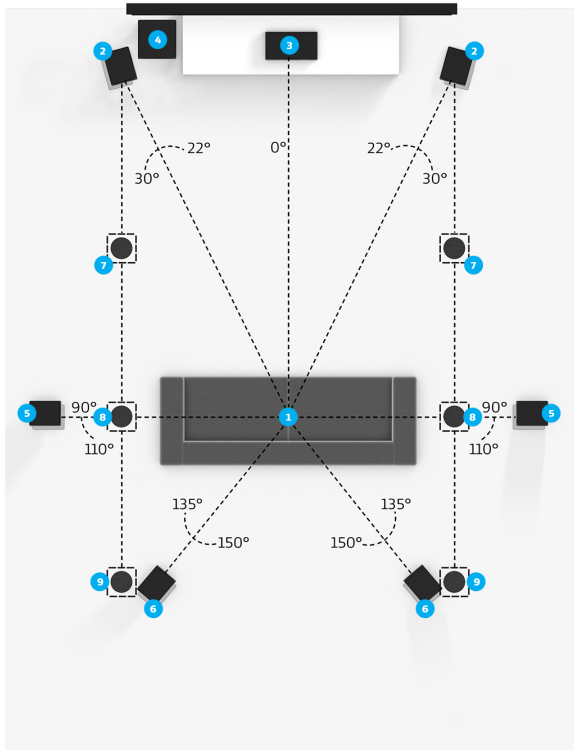

Speaker placement for 7.1.6 setup

7.1.6 Overhead Speakers

1. Seating position
2. Left and right speakers
3. Center speaker
4. Subwoofer
5. Left and right surround speakers
6. Left and right rear surround speakers
7. Left and right top front overhead speakers
8. Left and right top middle overhead speakers
9. Left and right top rear overhead speakers

Dolby Atmos speaker setups: What do these numbers mean?

When shopping for Dolby Atmos home theater components, you'll see a new way of describing speaker configurations.

7.1.6

This refers to the number of traditional surround speakers (front, center, surround, etc.)

This number refers to how many powered subwoofers you can connect to your receiver.

This refers to how many overhead or Dolby Atmos enabled speakers you can use in your Dolby Atmos capable setup.



Perspective detail for 7.1.6 setup

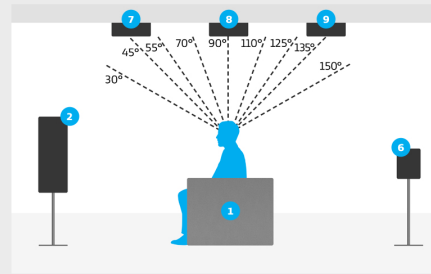

Overhead speaker placement detail for 7.1.6 setup



Home Theater Speaker Guide

Optimize your sound system that includes Dolby Atmos® technology with this step-by-step guide to the best speaker setup.

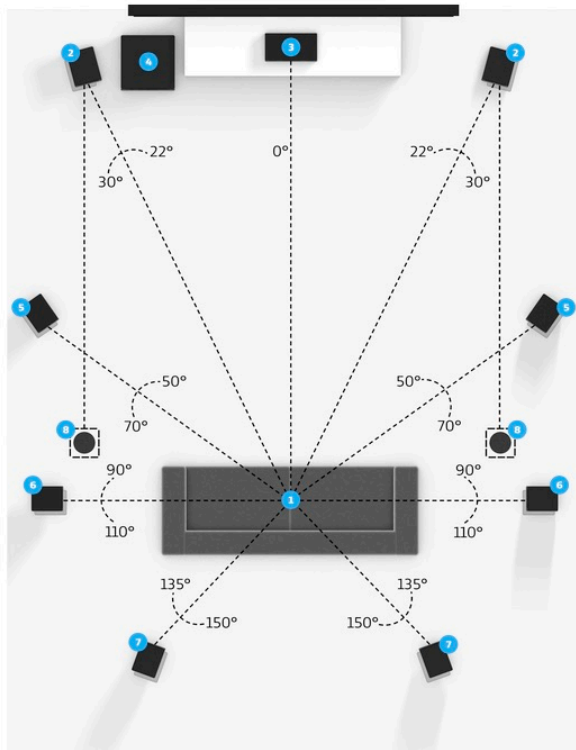

Speaker placement for 9.1.2 setup

9.1.2 Overhead Speakers

1. Seating position
2. Left and right speakers
3. Center speaker
4. Subwoofer
5. Left and right wide speakers
6. Left and right surround speakers
7. Left and right rear surround speakers
8. Left and right top middle overhead speakers

Dolby Atmos speaker setups: What do these numbers mean?

When shopping for Dolby Atmos home theater components, you'll see a new way of describing speaker configurations.

9.1.2

This refers to the number of traditional surround speakers (front, center, surround, etc.)

This number refers to how many powered subwoofers you can connect to your receiver.

This refers to how many overhead or Dolby Atmos enabled speakers you can use in your Dolby Atmos capable setup.



Perspective detail for 9.1.2 setup

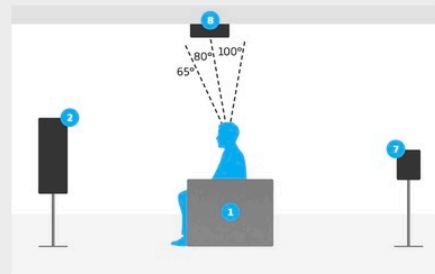

Overhead speaker placement detail for 9.1.2 setup

Figure 23: Standard 9.1.2 setup with overhead speakers.



Home Theater Speaker Guide

Optimize your sound system that includes Dolby Atmos® technology with this step-by-step guide to the best speaker setup.

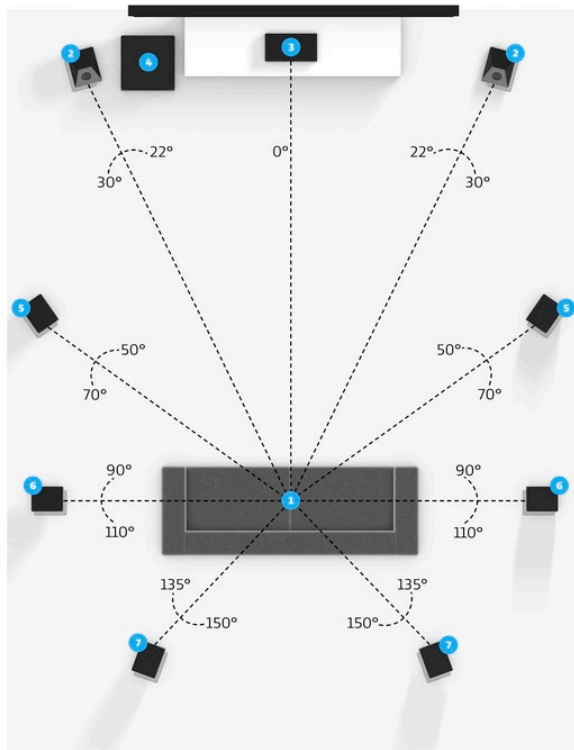

Speaker placement for 9.1.2 setup

9.1.2 Dolby Atmos Enabled Speakers

1. Seating position
2. Left and right Dolby Atmos enabled speakers
3. Center speaker
4. Subwoofer
5. Left and right wide speakers
6. Left and right surround speakers
7. Left and right rear surround speakers

Dolby Atmos speaker setups: What do these numbers mean?

When shopping for Dolby Atmos home theater components, you'll see a new way of describing speaker configurations.

9.1.2

This refers to the number of traditional surround speakers (front, center, surround, etc.)

This number refers to how many powered subwoofers you can connect to your receiver.

This refers to how many overhead or Dolby Atmos enabled speakers you can use in your Dolby Atmos capable setup.



Perspective detail for 9.1.2 setup

Figure 24: Standard 9.1.2 setup with Dolby Atmos enabled speakers.



Home Theater Speaker Guide

Optimize your sound system that includes Dolby Atmos® technology with this step-by-step guide to the best speaker setup.

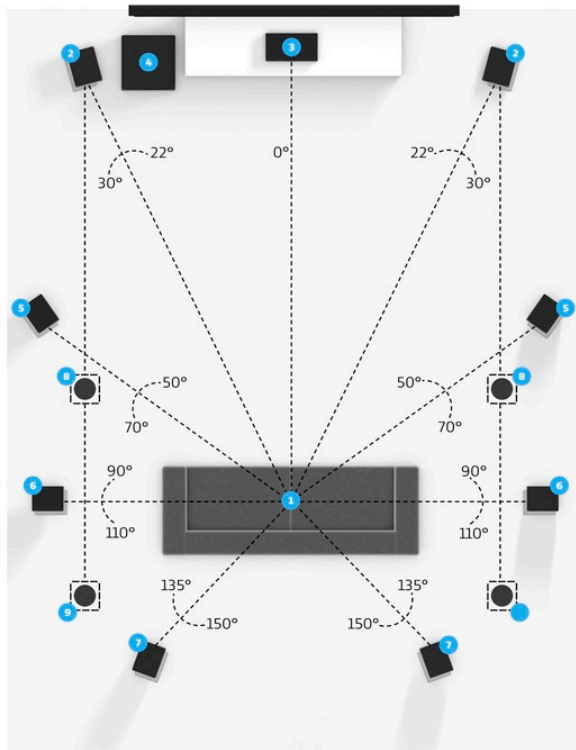

Speaker placement for 9.1.4 setup

9.1.4 Overhead Speakers

1. Seating position
2. Left and right speakers
3. Center speaker
4. Subwoofer
5. Left and right wide speakers
6. Left and right surround speakers
7. Left and right rear surround speakers
8. Left and right top front overhead speakers
9. Left and right top rear overhead speakers

Dolby Atmos speaker setups: What do these numbers mean?

When shopping for Dolby Atmos home theater components, you'll see a new way of describing speaker configurations.

9.1.4

This refers to the number of traditional surround speakers (front, center, surround, etc.)

This number refers to how many powered subwoofers you can connect to your receiver.

This refers to how many overhead or Dolby Atmos enabled speakers you can use in your Dolby Atmos capable setup.



Perspective detail for 9.1.4 setup

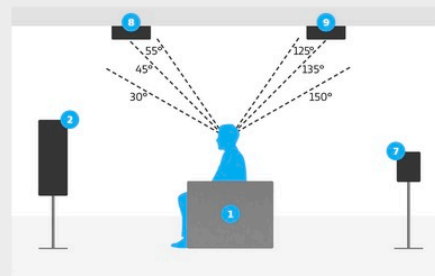

Overhead speaker placement detail for 9.1.4 setup

Figure 25: Standard 9.1.4 setup with overhead speakers.



Home Theater Speaker Guide

Optimize your sound system that includes Dolby Atmos® technology with this step-by-step guide to the best speaker setup.

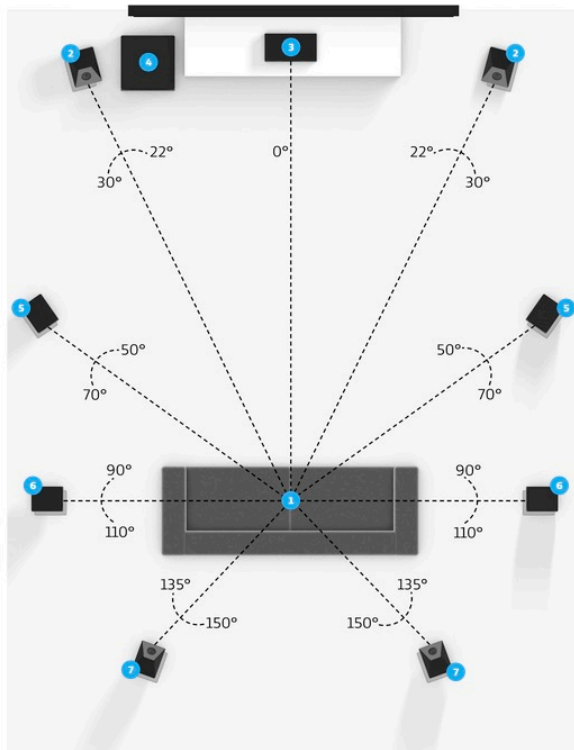

Speaker placement for 9.1.4 setup

9.1.4 Dolby Atmos Enabled Speakers

1. Seating position
2. Left and right front Dolby Atmos enabled speakers
3. Center speaker
4. Subwoofer
5. Left and right wide speakers
6. Left and right surround speakers
7. Left and right rear Dolby Atmos enabled surround speakers

Dolby Atmos speaker setups: What do these numbers mean?

When shopping for Dolby Atmos home theater components, you'll see a new way of describing speaker configurations.

9.1.4

This refers to the number of traditional surround speakers (front, center, surround, etc.)

This number refers to how many powered subwoofers you can connect to your receiver.

This refers to how many overhead or Dolby Atmos enabled speakers you can use in your Dolby Atmos capable setup.



Perspective detail for 9.1.4 setup

Figure 26: Standard 9.1.4 setup with Dolby Atmos enabled speakers.



Home Theater Speaker Guide

Optimize your sound system that includes Dolby Atmos® technology with this step-by-step guide to the best speaker setup.

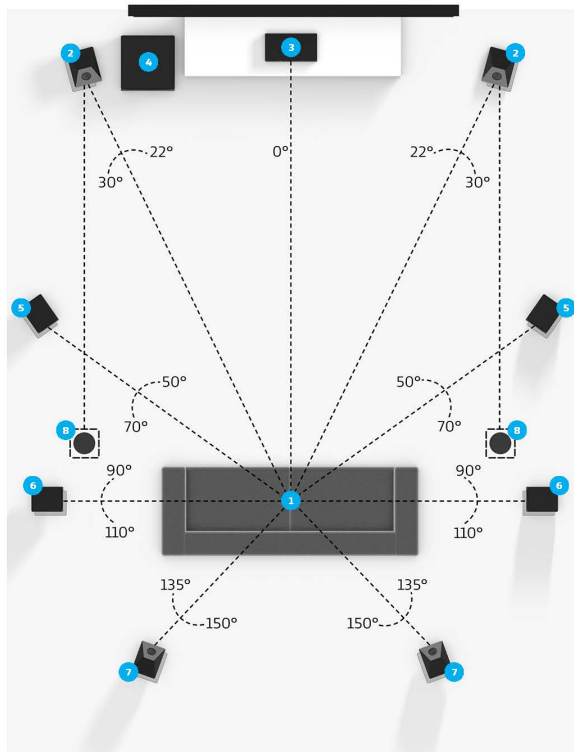

Speaker placement for 9.1.6 setup

9.1.6 Hybrid Dolby Atmos Enabled Speakers / Overhead

1. Seating position
2. Left and right front Dolby Atmos enabled speakers
3. Center speaker
4. Subwoofer
5. Left and right wide speakers
6. Left and right surround speakers
7. Left and right rear Dolby Atmos enabled speakers
8. Left and right top middle overhead speakers

Dolby Atmos speaker setups: What do these numbers mean?

When shopping for Dolby Atmos home theater components, you'll see a new way of describing speaker configurations.

9.1.6

This refers to the number of traditional surround speakers (front, center, surround, etc.)

This number refers to how many powered subwoofers you can connect to your receiver.

This refers to how many overhead or Dolby Atmos enabled speakers you can use in your Dolby Atmos capable setup.



Perspective detail for 9.1.6 setup

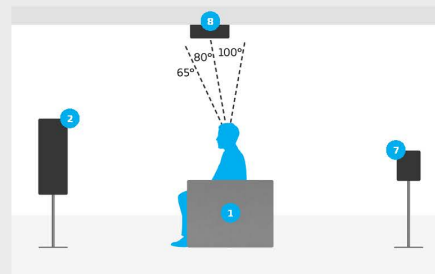

Overhead speaker placement detail for 9.1.6 setup



Home Theater Speaker Guide

Optimize your sound system that includes Dolby Atmos® technology with this step-by-step guide to the best speaker setup.

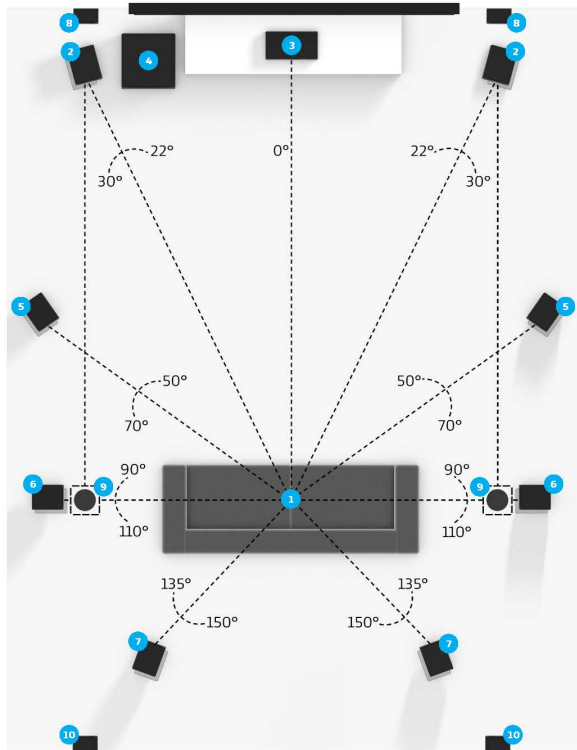

Speaker placement for 9.1.6 setup

9.1.6 Overhead Speakers

1. Seating position
2. Left and right speakers
3. Center speaker
4. Subwoofer
5. Left and right wide speakers
6. Left and right surround speakers
7. Left and right rear surround speakers
8. Left and right front height speakers
9. Left and right top middle overhead speakers
10. Left and right rear height speakers

Dolby Atmos speaker setups: What do these numbers mean?

When shopping for Dolby Atmos home theater components, you'll see a new way of describing speaker configurations.

9.1.6

This refers to the number of traditional surround speakers (front, center, surround, etc.)

This number refers to how many powered subwoofers you can connect to your receiver.

This refers to how many overhead or Dolby Atmos enabled speakers you can use in your Dolby Atmos capable setup.



Perspective detail for 9.1.6 setup

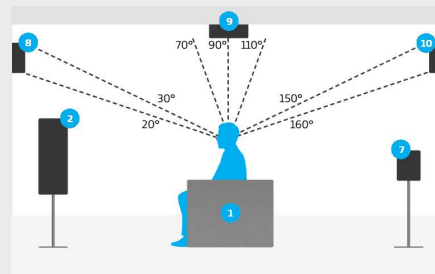

Overhead speaker placement detail for 9.1.6 setup



Home Theater Speaker Guide

Optimize your sound system that includes Dolby Atmos® technology with this step-by-step guide to the best speaker setup.

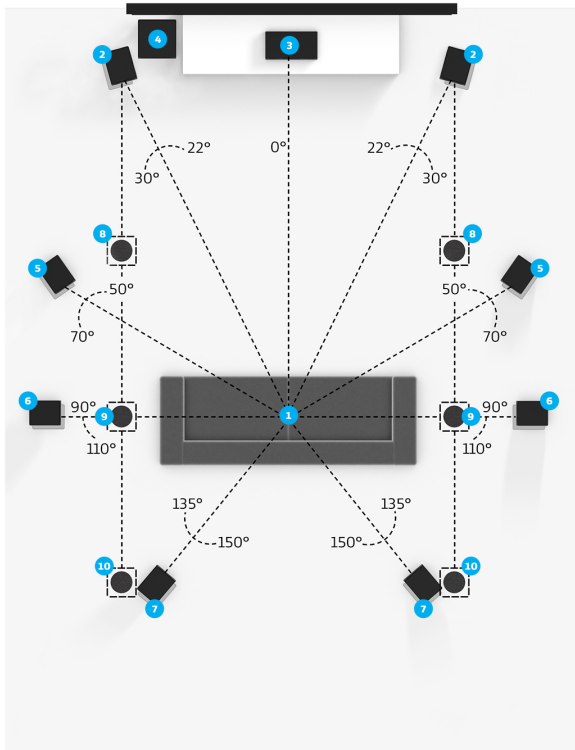

Speaker placement for 9.1.6 setup

9.1.6 Overhead Speakers

1. Seating position
2. Left and right speakers
3. Center speaker
4. Subwoofer
5. Left and right wide speakers
6. Left and right surround speakers
7. Left and right rear surround speakers
8. Left and right top front overhead speakers
9. Left and right top middle overhead speakers
10. Left and right top rear overhead speakers

Dolby Atmos speaker setups: What do these numbers mean?

When shopping for Dolby Atmos home theater components, you'll see a new way of describing speaker configurations.

9.1.6

This refers to the number of traditional surround speakers (front, center, surround, etc.)

This number refers to how many powered subwoofers you can connect to your receiver.

This refers to how many overhead or Dolby Atmos enabled speakers you can use in your Dolby Atmos capable setup.



Perspective detail for 9.1.6 setup

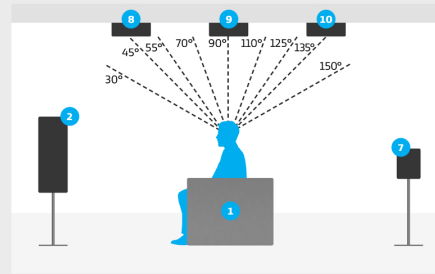

Overhead speaker placement detail for 9.1.6 setup



Home Theater Speaker Guide

Optimize your sound system that includes Dolby Atmos® technology with this step-by-step guide to the best speaker setup.

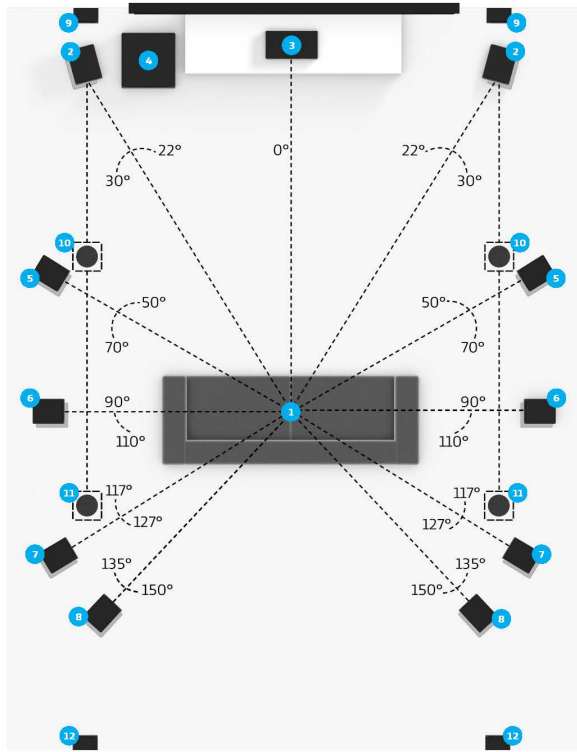

Speaker placement for 11.1.8 setup

11.1.8 Overhead Speakers

1. Seating position
2. Left and right speakers
3. Center speaker
4. Subwoofer
5. Left and right wide speakers
6. Left and right surround speakers
7. Left and right surround 1 speakers
8. Left and right rear surround speakers
9. Left and right front height speakers
10. Left and right top front overhead speakers
11. Left and right top rear overhead speakers
12. Left and right rear height speakers

Dolby Atmos speaker setups: What do these numbers mean?

When shopping for Dolby Atmos home theater components, you'll see a new way of describing speaker configurations.

11.1.8

This refers to the number of traditional surround speakers (front, center, surround, etc.)

This number refers to how many powered subwoofers you can connect to your receiver.

This refers to how many overhead or Dolby Atmos enabled speakers you can use in your Dolby Atmos capable setup.



Perspective detail for 11.1.8 setup

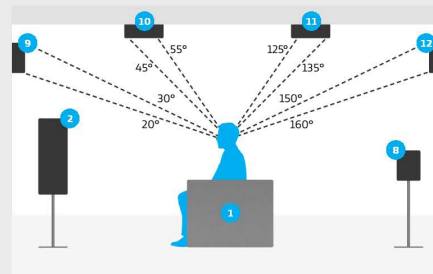

Overhead speaker placement detail for 11.1.8 setup

4. Additional Speaker Placement Guidelines

In addition to the typical configurations in the previous section, Dolby Atmos can support more speaker positions, up to a maximum of 34 total (for example, 24.1.10).

This section focuses on the placement of speakers, which may be added to the positions covered in section 3. For clarity, the positions covered in section 3 were:

- left/right speaker pair
- left surround/right surround speaker pair
- left rear surround/right rear surround speaker pair
- left wide/right wide speaker pair
- left top front overhead/right top front overhead speaker pair
- left top middle overhead/right top middle overhead speaker pair
- left top rear overhead/right top rear overhead speaker pair

For information on how to position these standard speaker positions, please refer to section 3.

Listener-Level Speaker Placement Guidelines

This section provides placement guidelines for the following nontraditional listener speakers:

- left center/right center speaker pair
- left screen/right screen speaker pair
- left surround 1/right surround 1 speaker pair
- left surround 2/right surround 2 speaker pair
- left rear surround 1/right rear surround 1 speaker pair
- left rear surround 2/right rear surround 2 speaker pair
- left center surround/right center surround speaker pair
- center surround speaker

In the following descriptions and examples, the term center-front reference denotes an imaginary line between the listener position and the middle of the screen or the placement of the center speaker.

Note that, in all of these examples, speakers are added in pairs. This is crucial to ensure an optimal Dolby Atmos playback environment.

Left center/right center speaker pair

The left center and right center speakers should ideally be placed at approximately 15 degrees between the left and right speakers and the center-front reference. If the left screen and right screen speakers are included in the speaker layout, we recommend that distances between the left and right, left center and right center, left screen and right screen, and center speakers be subdivided and that the left center and right center speakers be placed at approximately 30 degrees from the center-front reference.

Figure 27 shows the range of angles at which the left center and right center speakers may be placed.

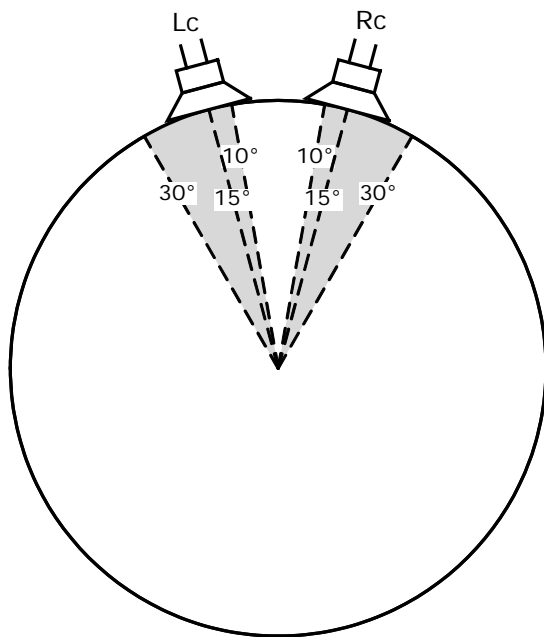

Figure 27: Left center and right center speaker placement.

Left screen/right screen speaker pair

The left screen and right screen speakers should be placed between the left center and right center speakers and the center-front reference. We recommend that the distances between the left and right, left center and right center, left screen and right screen, and center speakers be subdivided and that the left screen and right screen speakers be placed at approximately 15 degrees from the center-front reference.

Figure 28 shows the range of angles at which the left screen and right screen speakers may be placed.

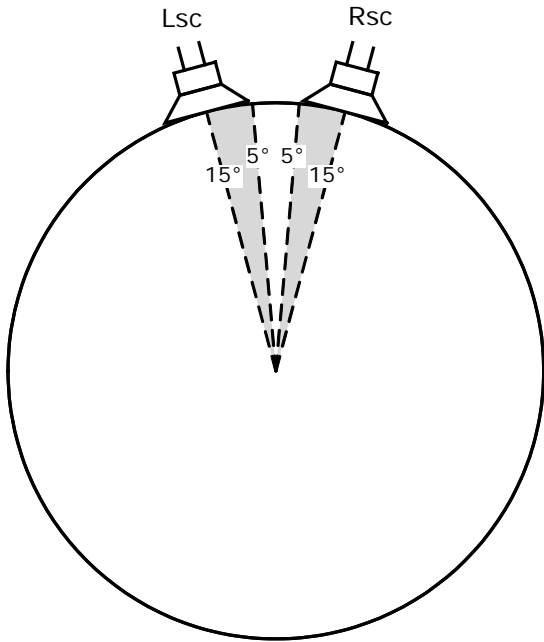

Figure 28: Left screen and right screen speaker placement.

Left surround 1/right surround 1 speaker pair

The left surround 1 and right surround 1 speakers should be placed between the left surround and right surround and left wide and right wide speakers at approximately 75 degrees from the center-front reference. Figure 29 shows the range of angles at which the left surround 1 and right surround 1 speakers may be placed.

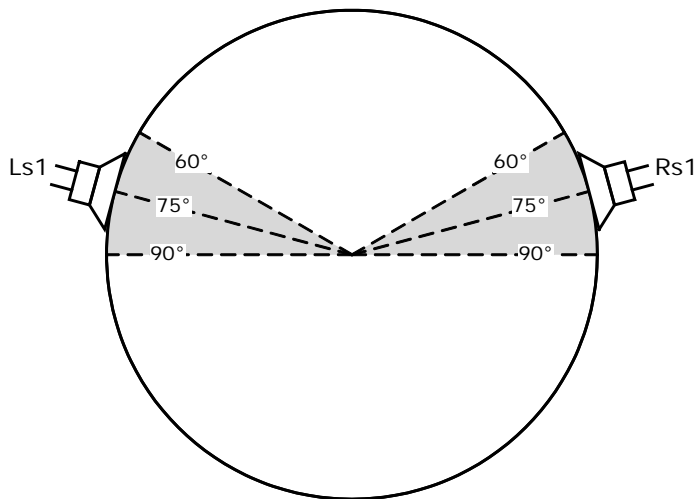

Figure 29: Left surround 1 and right surround 1 speaker placement.

Left surround 2/right surround 2 speaker pair

The left surround 2 and right surround 2 speakers should be placed between the left surround and right surround and left rear surround 1 and right rear surround 1 speakers at approximately 105 degrees from the center-front reference.

Figure 30 shows the range of angles at which the left surround 2 and right surround 2 speakers may be placed.

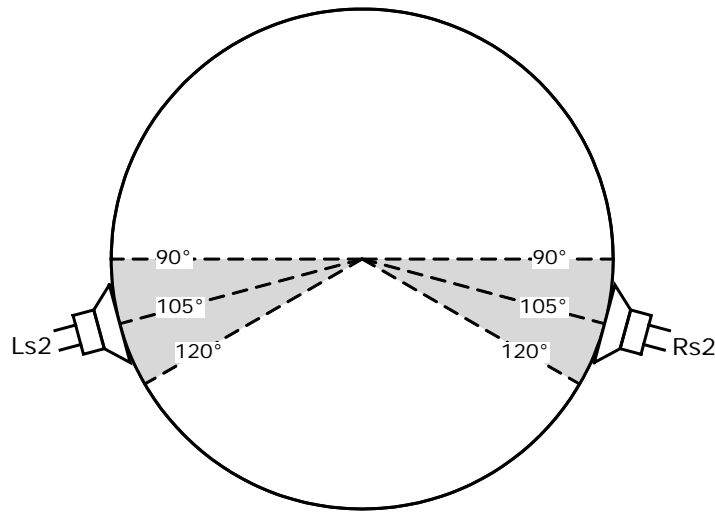

Figure 30: Left surround 2 and right surround 2 speaker placement.

Left rear surround 1/right rear surround 1 speaker pair

The left rear surround 1 and right rear surround 1 speakers should be placed between the left surround and right surround and left rear surround and right rear surround speakers at approximately 120 degrees from the center-front reference. If the left surround 2 and right surround 2 speakers are also included in the speaker layout, we recommend that the distances between left surround and right surround, left surround 2 and right surround 2, left rear surround 1 and right rear surround 1, and left rear surround and right rear surround speakers be subdivided so that the left rear surround 1 and right rear surround 1 speakers are closer to the left rear surround and right rear surround speakers at approximately 135 degrees from the center-front reference.

Figure 31 shows the range of angles at which the left rear surround 1 and right rear surround 1 speakers may be placed.

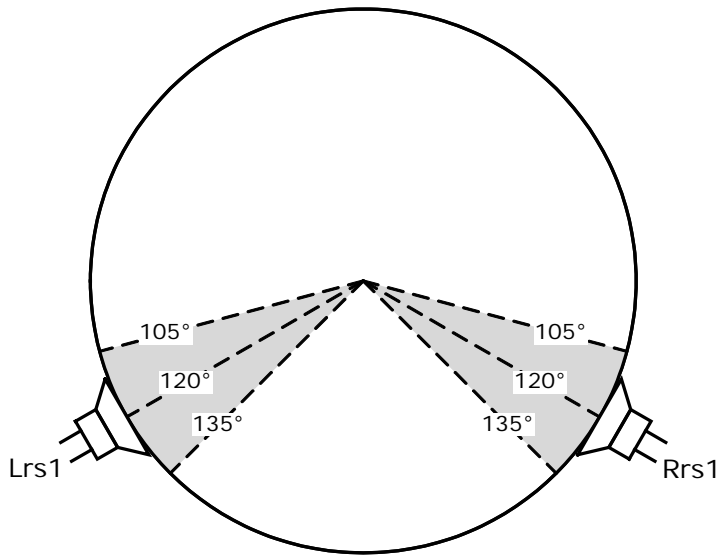

Figure 31: Left rear surround 1 and right rear surround 1 speaker placement.

Left rear surround 2/right rear surround 2 speaker pair

The left rear surround 2 and right rear surround 2 speakers should be placed between the left rear surround and right rear surround and left center surround and right center surround speakers at approximately 145 degrees from the center-front reference.

Figure 32 shows the range of angles at which the left rear surround 2 and right rear surround 2 speakers may be placed.

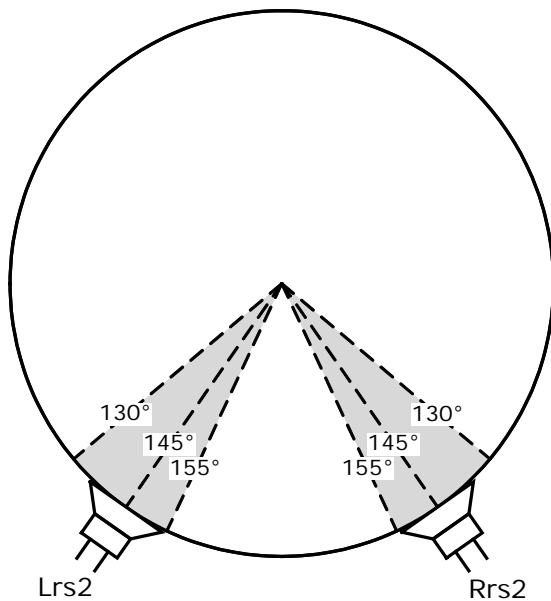

Figure 32: Left rear surround 2 and right rear surround 2 speaker placement.

Left center surround/right center surround speaker pair

The left center surround and right center surround speakers should be placed between the left rear surround, right rear surround, and center surround speakers at approximately 165 degrees from the center-front reference.

Figure 33 shows the range of angles at which the left center surround and right center surround speakers may be placed.

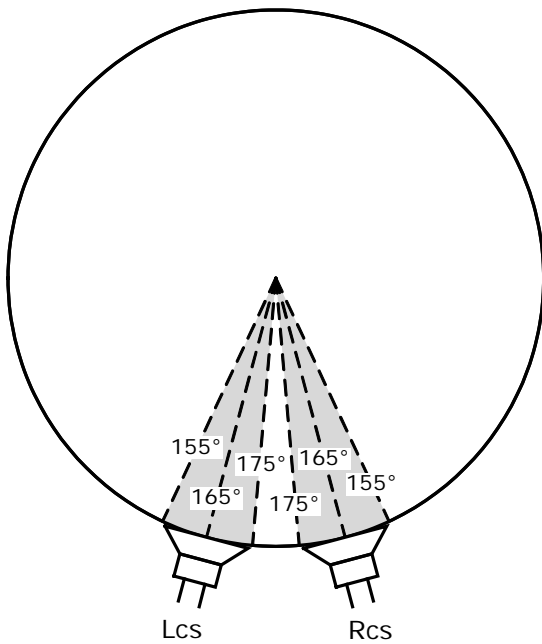

Figure 33: Left center surround and right center surround speaker placement.

Center surround speaker

The center surround speaker should be placed at 180 degrees from the center-front axis directly behind the listener.

Height Speaker Placement Guidelines

This section provides placement guidelines for the following height speakers:

- left front height/right front height speaker pair
- left rear height/right rear height speaker pair

In the following descriptions and examples, the term center-front reference denotes an imaginary line between the listener position and the middle of the screen or the placement of the center speaker.

In all of these examples, overhead speakers must be added to the playback system in pairs.

Left front height/right front height speaker pair

The left front height and right front height speakers should be mounted on the front wall (instead of on the ceiling) in line with an approximately 30 degrees horizontal from the center-front reference. This places the left front height and right front height speakers directly above the left and right speakers. If the left front height and right front height speakers must be mounted on the ceiling, they should be placed no more than one-eighth the distance to the middle of the room, approximately 45 degrees vertical from the center-front reference. This guidance represents a slight change from the original Dolby Pro Logic IIz documentation, which mandated that front height speakers not be placed inside the left and right main speakers (for example, closer to the center speaker).

The left front height and right front height speakers are typically included in Dolby Pro Logic IIz products.

Figures 34 and 35 show the range of angles at which the left front height and right front height speakers may be placed.

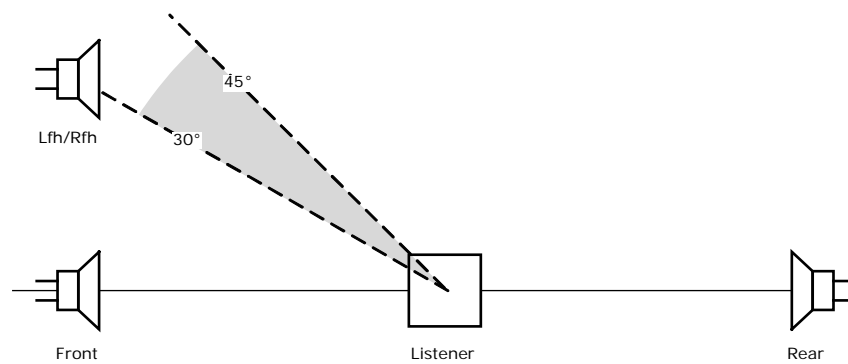

Figure 34: Side view of left front height and right front height speaker placement.

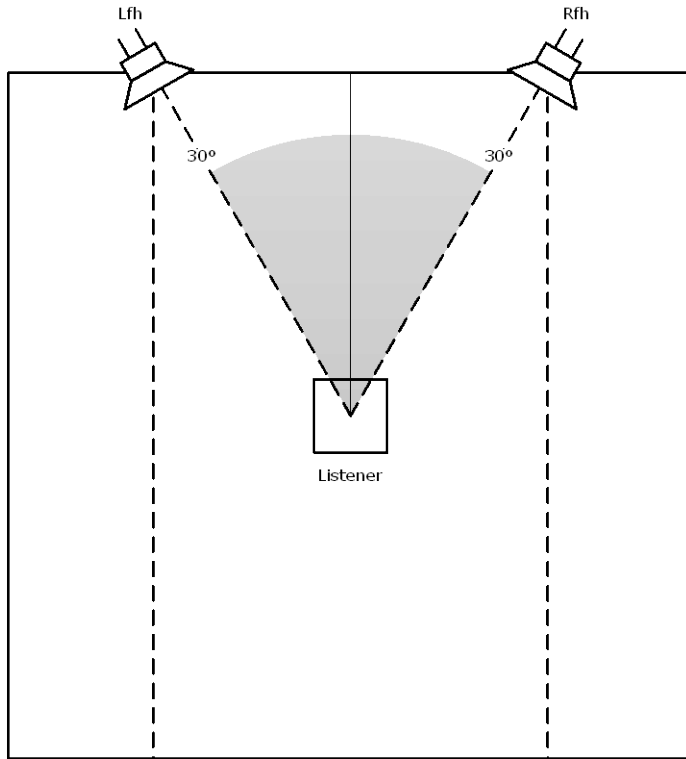

Figure 35: Top view of left front height and right front height speaker placement.

Left rear height/right rear height speaker pair

We recommend that the left rear height and right rear height speakers be mounted on the rear wall (instead of on the ceiling) in line with an approximately 30 degrees horizontal from the center-front reference. If the left rear height and right rear height speakers must be mounted overhead, they should be placed no more than one-eighth the distance to the middle of the room, approximately 135 degrees vertical from the center-front reference. Figures 36 and 37 show the range of angles at which the left rear height and right rear height speakers may be placed.

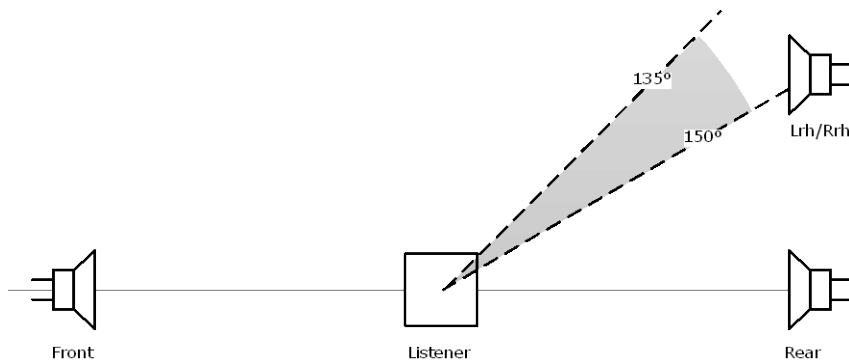

Figure 36: Side view of left rear height and right rear height speaker placement.

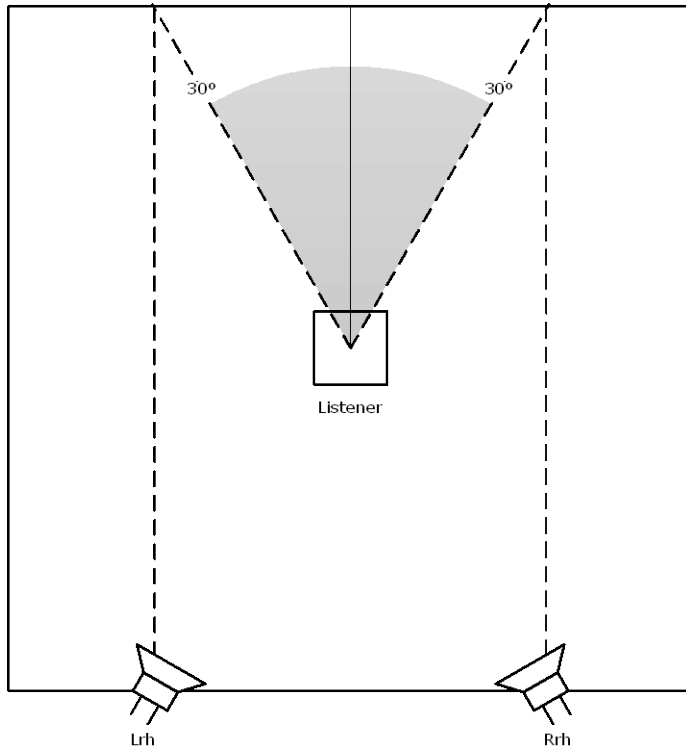

Figure 37: Top view of left rear height and right rear height speaker placement.

5. Dolby Surround Upmixer

When you invest in a Dolby Atmos home theater, you expect to get full use of all the components, even when the content you are playing is not mixed in Dolby Atmos. This includes taking advantage of overhead and Dolby Atmos enabled speakers to further enhance the playback experience.

Included in the Dolby Atmos technology bundle is a new advanced upmixer designed to be compatible with traditional channel-based as well as Dolby Atmos speaker systems. The Dolby surround upmixer expands the audio of channel-based content, including native stereo, 5.1, and 7.1 content, for playback through a Dolby Atmos system—regardless of speaker number or placement—while simultaneously honoring and maintaining the artist’s intent for the mix.

The Dolby surround upmixer analyzes and processes multiple perceptually spaced frequency bands, accurately steering each individually. The result is a surround playback experience characterized by precisely located audio elements and a more spacious ambience.

In a Dolby Atmos system, the channel-based mix is fully honored. Dolby Atmos enabled speakers and overhead speakers are employed to lend a sense of atmospheric or room effect to the listening experience. This new technology will process and upmix channel-based content to as many as 17 speaker locations at listener level and to 10 Dolby Atmos enabled or overhead speakers. Note: To maintain an accurate frontal audio image, the upmixer will not send upmixed audio to the left wide and right wide speakers or any speakers that are located between the left, center, and right speakers. Audio is not upmixed to the center surround speaker.

A center spread on/off control enables you to spread the center image across a wider front soundstage. This optional feature is ideally suited for playback of two-channel music content or playback of channel-based content in a home theater design that employs a wider screen configuration than typical installations.

Select the Dolby surround and center spread function from the user interface of the AVR or preprocessor, or from the system’s remote control.

The configurations noted herein are illustrative. We recommend that any overhead speaker installation be performed by professional installers with experience in installing overhead speakers.

Dolby, Dolby Atmos, Pro Logic, and the double-D symbol are registered trademarks of Dolby Laboratories. All other trademarks remain the property of their respective owners. © 2016 Dolby Laboratories, Inc. All rights reserved.