

Plastic Free Packaging Design Guide

g.co/Hardware/PackagingGuide

Google

What's inside?

Practical guidance and material insights for packaging and sustainability professionals.

Table of contents

Foreword →

The challenge →

Replacing plastic components →

Coating solutions

Shrink wrap removal

Closure labels

Paper tapes

Hang tabs

Protective product wraps

Inbox trays

Structural design →

The power of collaboration →

Glossary of terms →

Plastic free material library →

Acknowledgments →

Endnotes →





Foreword thinking

At Google, our mission is to organize the world's information and make it universally accessible and useful. We believe in the power of knowledge and are committed to sharing it in ways that positively impact people and the planet.

0.1 Challenges

Many companies have designed and engineered sustainable solutions for their products and services with impressive results and we think it's imperative that all companies do this. We also recognize that the challenges in building a more sustainable future are numerous and difficult. If all companies have to solve similar problems independently, then our collective progress will be slower.

0.2 Sharing knowledge

That's why we believe innovation in sustainability should be a collaborative endeavor, not a competitive one. In that spirit, we're sharing more than simply what we've achieved, but also how we achieved it. We've participated in many industry collaborations, but we're going further and openly publishing what we've learned for others to use, starting with our product packaging work. It's our goal to enable organizations with similar ambitions and engage others to improve the solutions we're sharing. We also hope other companies will be inspired to share their insights, amplify their impact and ultimately bring about the change we collectively want.



0.3 Our journey



Product packaging traditionally relies heavily on mixed material formats, particularly those incorporating plastic. This poses a significant recycling challenge and creates a significant waste stream if it isn't accepted for recycling.

In response, Google has researched solutions that prioritize both sustainability and performance. This guide documents our journey to eliminate plastics and transition our packaging to predominantly fiber-based materials for our consumer electronics products. We hope this guide serves as a resource for others aiming to reduce their reliance on mixed material formats and adopt fiber based solutions.

Through extensive material exploration, design optimization, and rigorous testing, we've identified viable alternatives to plastic that address key packaging elements. This guide offers practical guidance and material insights for product designers, packaging engineers, and sustainability leaders across industries. By sharing our learnings and collaborating with others, we hope to accelerate the transition to more sustainable packaging in a way that aligns innovation with environmental responsibility.

Meet the Google team

Design guide authors and contributors

Francesca Delle Cese

Packaging Design
Engineer Manager



Miguel Arevalo

Packaging
Sustainability Lead



David Bourne

Lead for
Environmental Strategy



Charlie Hutchinson

Structural Packaging
Design, Innovation Lead



Yang Xiang PhD

Packaging Materials
Engineer



Cole Hermann

Structural Packaging
Design, Innovation Lead



Rob Cook

Packaging Design
Engineer Lead



Abhinav Jha

Global Supply
Chain Manager



Nathan Gassmann

Lead for
Circular Economy



Robert Little

Sustainability
Strategy Lead
Recyclability SME





Section 1.0

The challenge of plastic in packaging

In this section

Confronting the ubiquity of plastic →

Google's guiding principles →

Key materials in packaging →

Fiber: An emerging solution →

Confronting the ubiquity of plastic

Plastic isn't an inherently unsustainable material and has actually revolutionized the packaging industry.

Its barrier properties extend product shelf life, especially for perishable products like food. Its low weight reduces transportation costs and carbon emissions compared to heavier materials like glass. Plastic's versatility has allowed for a wide variety of applications in packaging, leading to a multitude of mixed material packaging formats in the packaging industry.

However its ubiquity in packaging, particularly complex packaging, has created a high volume of mixed material waste that is difficult to recycle.¹ Consumer confusion around packaging recyclability is widespread and often results in improper disposal. Large volumes of plastic packaging often end up in landfills, waterways, and oceans harming ecosystems and wildlife as it slowly degrades into microplastics. It's a significant threat to the environment and ultimately our health. The plastic pollution crisis demands a fundamental shift in how we design, produce, use and dispose of plastic. **It's a major challenge, but one that can be addressed.**

¹ [The world's plastic pollution crisis, explained](#)

National Geographic, 2024





Recognizing an urgent need

Organizations across all sectors are increasingly seeking ways to reduce their packaging waste footprint and so are consumers.

“Avoiding products which have a lot of packaging”² is the number one action people worldwide are taking out of concern for the environment. We hope this guide serves as a practical tool to help organizations make faster decisions and design more recyclable packaging solutions. It offers actionable tips, design insights and examples for product designers, packaging engineers, and sustainability practitioners committed to minimizing plastic waste and maximizing fiber-based packaging recyclability.



Google recognizes the urgent need for packaging solutions that are more easily recycled. For our consumer electronics packaging, we’ve made a strategic shift away from plastics used in mixed-material formats. These formats complicate recycling efforts for consumers and material recovery facilities alike. For the consumer, deciding which packaging parts can be recycled and separating them is confusing and detracts from an otherwise delightful product unboxing experience. In October 2020 we made a commitment that by 2025 all of our consumer electronics packaging will be 100% plastic-free.

In our efforts to remove plastics, we’ve adopted the ISO 472³ definition of plastics: *“a material which contains as an essential ingredient a high polymer and which, at some stage in its processing into finished products, can be shaped by flow.”* This definition excludes materials like adhesives and inks.⁴ Even for these however, we conduct repulpability and recyclability testing to ensure that Google packaging materials can be widely recycled.

² [Earth Day 2022](#)
National Geographic, 2024

³ Per [ISO 0472-2013](#)
Plastic, noun. Material which contains as an essential ingredient a high polymer and which, at some stage in its processing into finished products, can be shaped by flow.

⁴ Note 1 to entry: Elastomeric materials, which are also shaped by flow, are not considered to be plastics.

Our guiding principles



These are fundamental to our approach. We strive to create packaging that:

Prioritizes recyclability

Materials must be widely compatible with existing and future recycling streams.

Minimizes waste

Optimizing packaging size and weight minimizes the overall material footprint.

Maximizes accessibility

Designed with everyone in mind, features like holes, lifts, and tabs promote intuitive component removal. [Learn more about our research in accessible packaging design.](#)

Protects products

Sustainable packaging cannot compromise a product's integrity. Replacing damaged products carries a significant environmental impact.

Embraces innovation

Creating new solutions demands constant exploration and collaboration.

Key materials in the world of packaging

Plastics

PP lamination

A plastic film laminated to paperboard, enhancing tensile strength, abrasion resistance and moisture protection. It is difficult to separate in recycling processes.



Shrink wrap

A versatile film used to bundle and protect packaging and create tamper evidence. Its low material value for recycling and tendency to contaminate recycling streams often leads to landfill disposal.



Plastic wraps for products

While offering product protection, traditional plastic films often lack economically viable recycling options and end up in landfills.



Plastic alternatives

Molded fiber

A renewable and recyclable alternative to plastic trays, engineered with cushioning properties for superior product protection during transit and handling.



Greyboard

A robust material made from recycled content, offering structural rigidity and impact resistance to protect product during shipping and handling while maintaining a premium appearance.



Corrugated paper

A sturdy and economical material made of fluted paper sandwiched between two liners. It offers excellent cushioning and protection for products during shipping and handling.



Fiber

An emerging solution

The shift toward fiber-based packaging is gaining momentum.

Materials like paper and cardboard offer a compelling alternative to conventional plastics; they are renewable but can also be made from recycled content. They break down easily and integrate into the vast majority of existing consumer-facing recycling systems.

While this transition presents opportunities, it also introduces challenges. Fiber-based solutions must meet the functional requirements for product packaging, particularly the protective properties that previously made plastic so popular. This necessitates new designs, materials, production methods, and supply chain adaptations.



Above: A fiber-based unglued packaging set



Section 2.0

Replacing plastic components

In this section

Coating solutions →

Shrink wrap removal →

Paper-based closure labels →

Paper tapes →

Molded fiber hang tabs →

Protective product wraps →

Molded fiber trays →



Let's get started

We want to share insights into the challenges, considerations, and innovative breakthroughs that pave the way for plastic-free packaging in the consumer electronics sector.

Transitioning to plastic-free packaging, and moving away from mixed material packaging formats demands a rethinking of traditional components. Achieving the necessary product protection, accessibility, aesthetic appeal, and responsible disposal—all while managing costs—required expansive material exploration and testing.

Google is committed to this transformation, actively seeking sustainable solutions without sacrificing performance.

What we'll address

Let's dive into the complexities of replacing several common plastic components within our packaging.

For each component, we'll share an overview of our fiber-based solution, the performance testing conducted, and the results that validated our choices.

Coating solutions →

Alternatives to plastic laminations that provide protection and visual appeal.



Shrink wrap removal →

Strategies to effectively safeguard retail box graphics during shipping without plastic shrink wrap.



Closure labels →

Solutions that ensure tamper-evident security and offer accessibility features.



Paper tapes →

Assembly solutions that maintain structural integrity without plastic tapes.



Molded fiber hang tabs →

Balancing strength with user-friendly design for product display.



Protective product wraps →

Materials that protect sensitive product surfaces and are compatible with recycling processes.



Molded fiber trays →

The shift to molded fiber trays from thermoformed plastic and the design optimizations required.





Shown:
Pixel 6 Pro packaging,
Fall 2021

Coating solutions

Coated and uncoated polypropylene (PP) films are commonly used in packaging.

Its popularity stems from its protective qualities. However, when laminated to paper-based packaging, it creates significant challenges for recycling.

Challenge

* * * * *

“The quest for a recyclable coating was a balancing act. We needed to maintain the protective qualities of PP film while ensuring it wouldn’t disrupt the paper recycling process. It was a challenge, but one that pushed us to innovate.”

- Francesca



Coating solutions



Lamination is a process that bonds multiple materials to form a stronger, more functional composite. In older Google packaging designs, a water-based adhesive was used to bind PP film to printed paper.

PP lamination has several advantages:

- Structural strength reinforces the paper, providing additional tensile strength to prevent tears and damage
- Scuffing / scratch resistance
- Moisture protection
- Visual appeal with a glossy or matte finish



Above:

Plastic film removed / separated in mill's hydropuller (repulping) system.

Unfortunately, PP laminated packaging disrupts paper recycling streams. During the pulping process, the plastic film does not break down like paper fibers. Instead, it must be screened out, ultimately contributing to landfill waste and reducing recycling yields. Large pieces of PP film float to the top of each recycling batch while small pieces are continuously strained out by size with a pressured screen and by density with cyclone cleaning.

Depending on the size and the collection system, the remains may not be recycled and could be landfilled. Replacing plastic laminations with coatings that are compatible with paper recycling is crucial to this goal. However, we recognize that even with coatings, maximizing fiber yield during recycling is essential.

Coating solutions

WESTERN MICHIGAN UNIVERSITY



Upper left: Waring blender
 Upper right: British disintegrator (deflaking)
 Bottom left: Screening (accepts)
 Bottom right: Screening (rejected material)

We collaborated with Western Michigan University (WMU), leveraging their expertise at the Paper Pilot Plant, to certify recyclability for our coating, varnish, ink, and paper combinations. The Fibre Boxboard Association test protocol for wax replacement corrugated containers guided this process.

The certification protocol involves two distinct phases.

One: Lab scale testing

- Testing repulpability to ensure material breaks down for a minimum 80% yield without operational issue.
- Testing deinkability (ISO 21993:2020/INGEDE Method 11) to test removing coatings or inks in the paper recycling process.
- Testing for the presence of “stickies” which are paper contaminants classified as tacky e.g. waxes, coatings, and soft adhesives.

Two: Pilot scale testing

- **Simulates real-world conditions:** Minimum 200lb of test material is processed alongside control paper stock.
- **Comprehensive score:** Evaluates operational impact, yield, color, strength, and stickiness of recycled fibers.



Coating solutions



Above: Sample Deflaked on disintegrator

Our PP lamination-free solutions were extensively tested and successfully met our operational and optical/mechanical performance criteria.

This testing included running recycled pulps from Google's new plastic-free printed packaging designs alongside unprinted paper stock and our original PP laminated solution for comparison purposes. While both Megami varnish and Actega coating passed the recyclability test and met our performance requirements, **we have deprecated the Actega coating solution** due to some manufacturing challenges that our team is actively working to resolve.

The Megami varnish has been successfully implemented at scale. Details on these scalable solutions can be found in our [Material Library](#).



Above: Fiber accepts after screening during repulpability test

As collection and recycling infrastructure for fiber-based packaging changes, design modifications and collaboration with producer responsibility organizations will be important to ensure high acceptance rates. Our intention is to understand the criteria and assessment methods being developed and optimize our packaging solutions for seamless integration into evolving recycling streams.

Coating solutions

Our coating qualification process

While qualification needs will vary greatly by company and product needs, below is Google’s process to ensure our suppliers deliver consistent, high-quality coatings.

We employ a 6-phase qualification plan emphasizing compatibility, print excellence, real-world performance, and a commitment to continuous improvement.



Phase 1

Initial vetting

- Technical Data Sheets (TDS) and Material Safety Data Sheets (MSDS) review to verify alignment with our safety and environmental standards.
- Coating and ink vendors compatibility testing, particularly for specialized print needs.
- Critical to Quality (CTQ): Early scuffing and bend resistance data as primary indicators of performance.
- Sustainability: Repulpability, recyclability, and deinkability tests aligning with our environmental goals.

Phase 2

Printing excellence

- G7 color management for consistent color reproduction.
- Quantifiable cosmetic standard to assess defects with variable tolerances based on visibility.

Panels less than 200mm x 200mm

Defect size	Cosmetic class			
	LOGO	A	B	C
<0.08 mm ²	2	3	OK	OK
0.08-0.2 mm ²	NG	2	OK	OK
0.2-0.5 mm ²	NG	1	2	OK
0.5-≤ 1.0 mm ²	NG	NG	1	OK
1.0 - 3.0 mm ²	NG	NG	NG	1
> 3.0 mm ²	NG	NG	NG	NG

Coating solutions

Phase 3



Laboratory testing

In-depth testing for abrasion resistance, fold cracking, alcohol and water resistance, and adhesion.

Phase 4



Box assembly

Monitoring for potential assembly issues like deboss cracking or corner bunching, optimizes production setup.

Phase 5



Contract manufacturer test

Full assembly simulation at our packing lines identifies potential cosmetic issues and assesses compatibility with labels and downstream processes.

Phase 6



Reliability testing

Comprehensive vibration, drop, environmental, and cosmetic testing ensures the coating withstands supply chain and user conditions.

Coating solutions

Opportunities for improvement

Improving deinkability:

Exploring ink/coating pairings that further minimize ink residuals after recycling could yield even higher quality recycled fibers.

Shown:

Ink residual spots of deinked pulps.

S1: Megami UV inks+PP lam

S2: Megami UV inks+Megami varnish



Fold/score protection:

We continue to research coatings with even greater flexibility to prevent artwork damage during folding while maintaining recyclability, ensuring a flawless presentation from production to the end-user.



Coating solutions



Key insights ¹

Our journey to replace plastic lamination with coatings taught us valuable lessons about material interactions, print quality, and supply chain management. Here's a look at some key insights we've gained so far:

- **Our final coating choice** exhibited comparable abrasion and fold/score cracking resistance to the PP laminate, ensuring artwork protection. It also preserved cosmetic performance and visual appeal essential to our brand standards.
- **Strong adhesives** used on closure labels meant to ensure tamper-evidence could damage the box surface upon removal and compromise product presentation. We tested many to find options that would avoid damage with our coating solution.
- **High-tack UV offset inks**, while essential for coating adhesion, could cause paper picking if paper surface strength is insufficient. We tested paper sources and established surface strength benchmarks (wax pick method) of 13+ for coated grades and 18+ for uncoated grades.
- **UV offset inks** have a narrower process window for fountain solution-ink balance when compared to conventional offset inks. If UV inks are emulsified excessively by the fountain solution, it can lead to irregular dot shapes. We proactively optimized fountain-ink balance during printing, minimizing fountain solution and ensuring optimal dot quality.

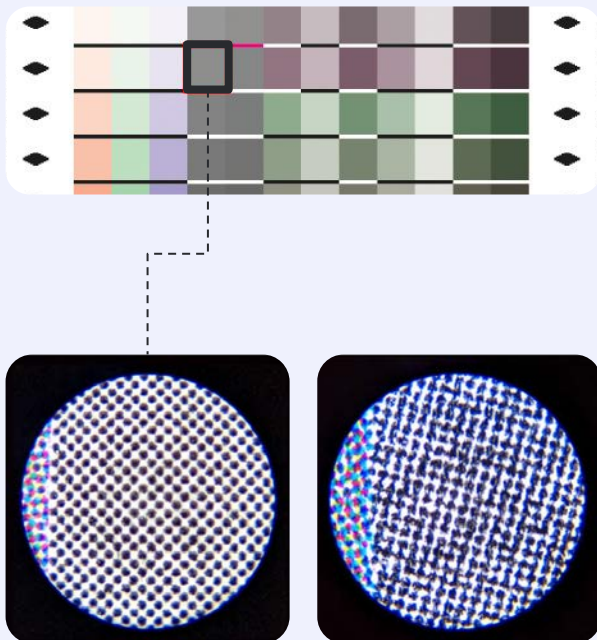

Above: Dot quality comparison between print runs to evaluate dot gain/shape

Coating solutions



Key insights ²

- **Storage conditions and pre-mixing procedures** for coating materials can significantly impact coating performance and machine efficiency.
- **Real-world shelf-life for a coating material** is determined by the unique coating formulation and may differ from the technical data sheets of individual chemicals in the formulation. We developed specific operational requirements to manage the shelf life of our specific formulation.
- **When testing various coating solutions in a large-scale stress build**, we discovered that machine cleaning requirements could disrupt production. We eliminated options requiring more frequent cleaning to avoid costly production problems.
- **We partnered with our vendors** to enable production scalability and consistent supply of sustainable packaging solutions. This collaboration reduced the initial investment needed for development and testing. These solutions are now readily accessible for use by other brands with details available through our material vendors.

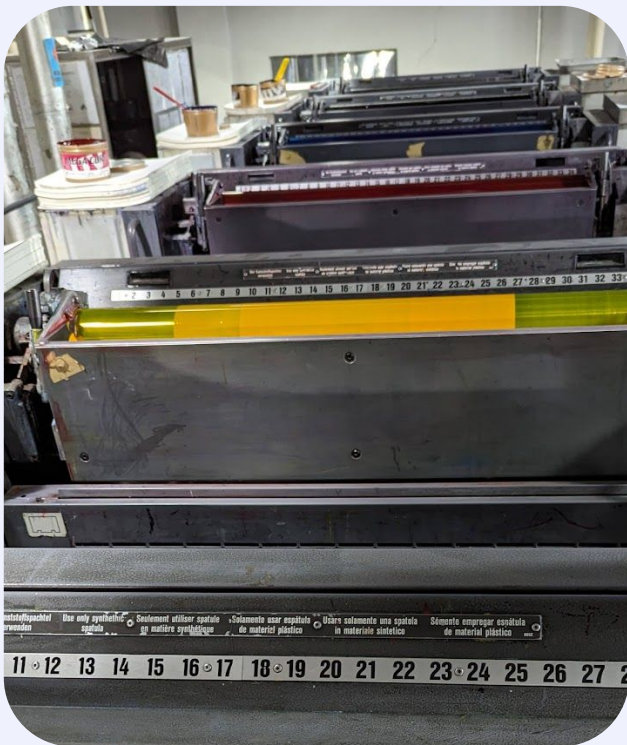

Printing press: Manroland R700



Shrink wrap removal

Plastic shrink wrap, while versatile, poses significant recycling challenges.

It's difficult to effectively separate from other materials in recycling systems, offers limited value for recyclers, and ultimately has a high chance of landfill disposal.

Challenge

* * * * *

“Shrink wrap was been an industry standard way to create tamper evidence and closure, but in designing a more recyclable alternative I think we created an even better unboxing experience.”

- Charlie



Shrink wrap removal

Our approach

To replace shrink wrap, we made several key packaging design changes to maintain product protection, tamper-evidence, and a premium aesthetic without compromising our sustainability goals:

- UV protective coatings safeguard packaging artwork from abrasion.
- Specialized adhesives for fiber-based closure labels provide a strong, tamper-evident seal. Closure labels were not previously needed with shrink wrapped products.
- Structural design revisions on all box styles compensate for the loss of tensile strength that shrink wrap provided.



Success criteria and testing

- Our packaging undergoes extensive reliability testing, including vibration, drop, environmental exposure, and compression simulations. This ensures that consumers receive products in pristine condition, even without shrink wrap.
- Cosmetic performance is evaluated through rub/abrasion tests and supply chain simulations. These guarantee the package maintains its visual appeal throughout its journey.
- Recyclability (repulpability, deinkability, etc) testing ensures our packaging has improved compatibility with paper recycling systems.



Shrink wrap removal

Key insights ¹

Structural evolution for plastic removal

The Roll End Lock Front (RELF) box style poses unique challenges when eliminating shrink wrap different from those for telescoping boxes and tuck-end cartons. This section focuses on considerations for RELF and corrugated boxes, highlighting strategies to maintain both structural integrity and visual appeal without plastic wraps.

Top sheet appearance

To achieve a premium unboxing experience, we've prioritized a high-quality top sheet for corrugated structures. This ensures a smooth, visually appealing surface while minimizing the prominence of corrugated ribs. Additionally, using F-flute corrugated material reduces rib visibility and can be balanced with other structural and cost requirements.

For an even more polished presentation when the box is opened, a color-matched inside liner can further mask the ribs. These refinements are especially important when shrink wrap is removed, as they maximize abrasion resistance and maintain a high-quality appearance throughout distribution and on-shelf display.

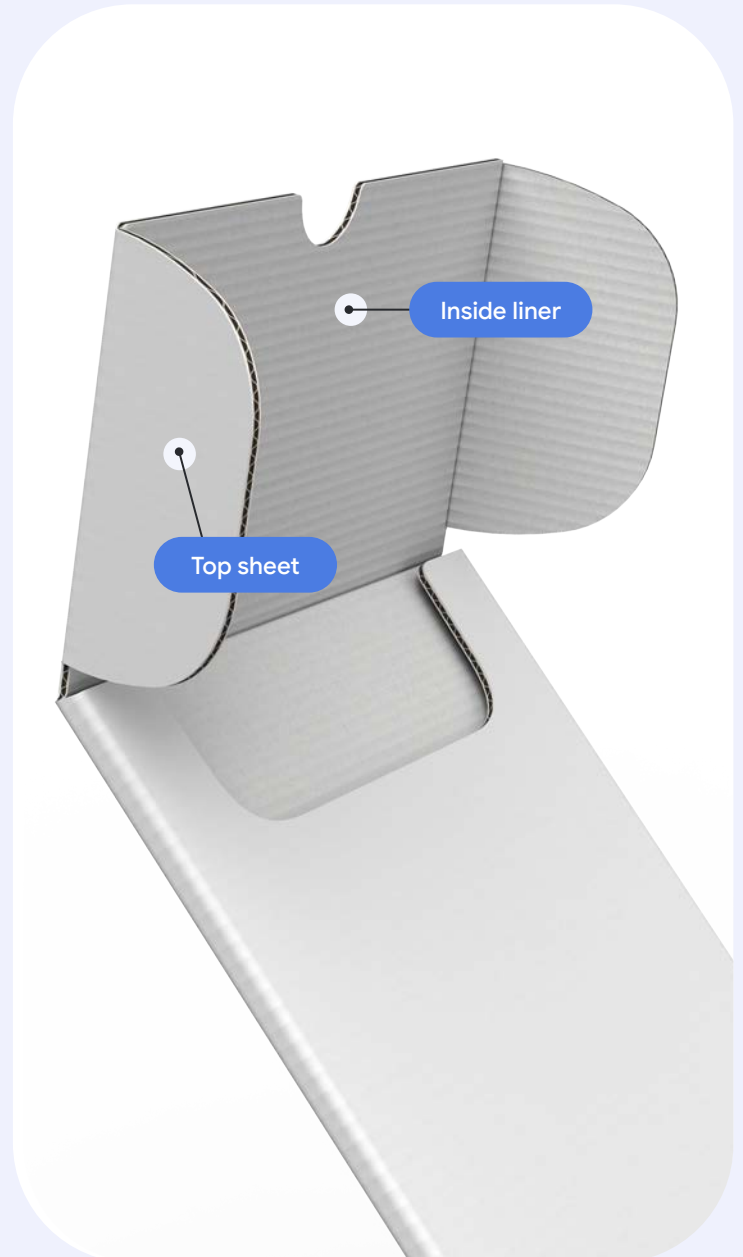

Shrink wrap removal

Key insights ²

Shrink wrap, while creating a unified package, can mask potential structural weaknesses. Without it, it's vital to ensure that large panel elements, particularly the lid, maintain their integrity to protect the product and preserve a pristine appearance throughout the supply chain. **Here are four key strategies:**

Maintain lid integrity

1: Lid stiffeners

Drop testing may reveal bowing or stress marks on the RELF box lid. If that occurs, it's essential to add a stiffening element. Greyboard, a recyclable option made from recycled material, is effective when starting at 1mm thickness.

2: Molded fiber versatility

If a molded fiber tray is already part of the design for product support, its flange can be extended to improve lid stiffness. In some scenarios a modest flange extension is sufficient, however extending it to the entire lid may further increase support.

The visual on the right demonstrates how a short flange can be adhered inside the lid (lower image) to hide it in the final assembly.

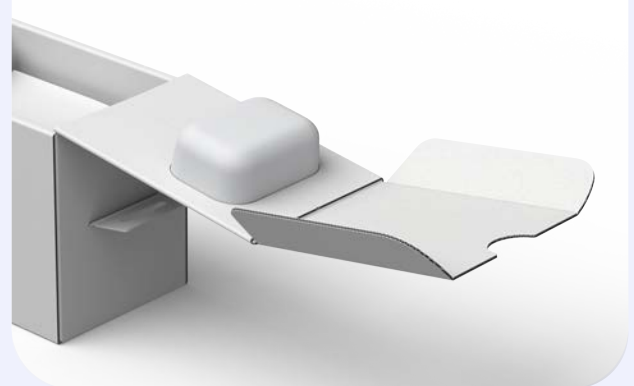
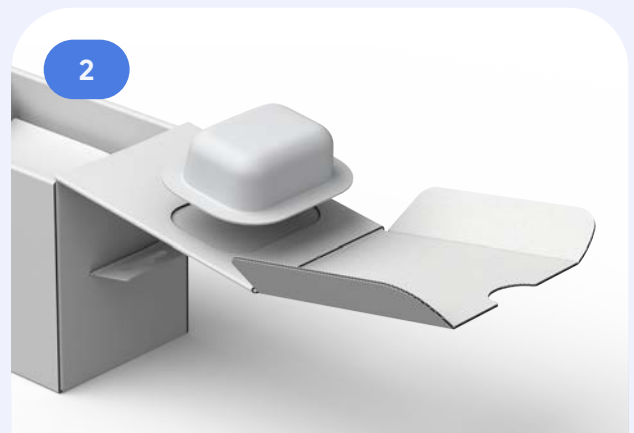

Shown: Flange extends into lid for structural support

Shrink wrap removal

Key insights ³

Preserve box cosmetics

3: Shipper adjustment

To minimize abrasion and maintain the pristine presentation of the retail box, we flip the orientation of the corrugated shipper's liner. This ensures the smoother, thicker kraft paper faces inward, in contact with the finished box surface, rather than the exposed corrugated ribs.

4: Gentle protection

Tissue or kraft paper buffer:
When necessary to further minimize abrasion, a thin layer of tissue or kraft paper can be inserted between retail boxes within the corrugated shipper. This creates a gentle barrier, preserving the pristine packaging surface, while remaining compatible with paper recycling streams.

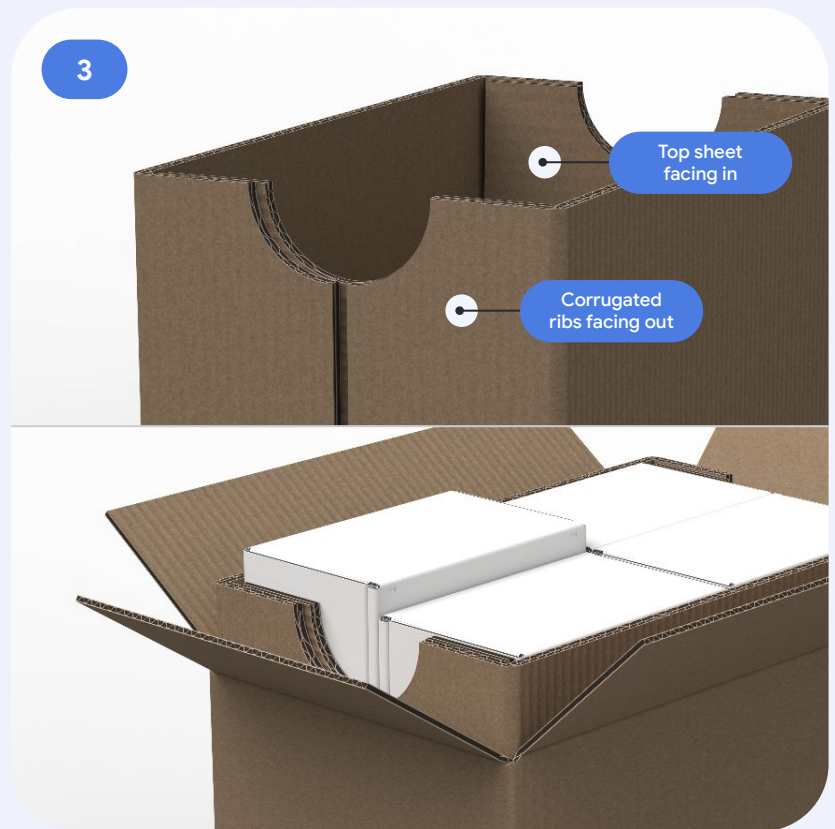



Closure labels

Closure labels are a practical and versatile solution for maintaining product integrity.

By prioritizing paper-based labels, we gain significant advantages:

- Plastic waste reduction
- Improved ease of opening for everyone

Challenge

* * * * *

“Plastic closure labels may seem convenient, but their small plastic components can create headaches in recycling operations.”

- Yang



Closure labels

Inclusivity at the forefront

As we strive to create packaging that's better for the environment, we also want to create a better, more inclusive experience for consumers.

We performed user testing to understand the unboxing experience of diverse individuals. We partnered with 36 participants and actively included those with mobility limitations, vision impairments, alongside those with no specific accessibility requirements.

Our study revealed that paper closure labels consistently outperformed plastic ones in ease of opening across all participant groups. The plastic label was identified as the most difficult to open for those with visual impairments, likely due to its smaller size and lack of tactile differentiation from the box surface.

These results show that paper closure labels are an important consideration in designing accessible packaging. Their ease of grip and intuitive design appear to benefit users with varying dexterity and visual capabilities.



Our study revealed:

Paper closure labels are easier to open than their plastic counterparts.

Closure labels

Parametric design layout

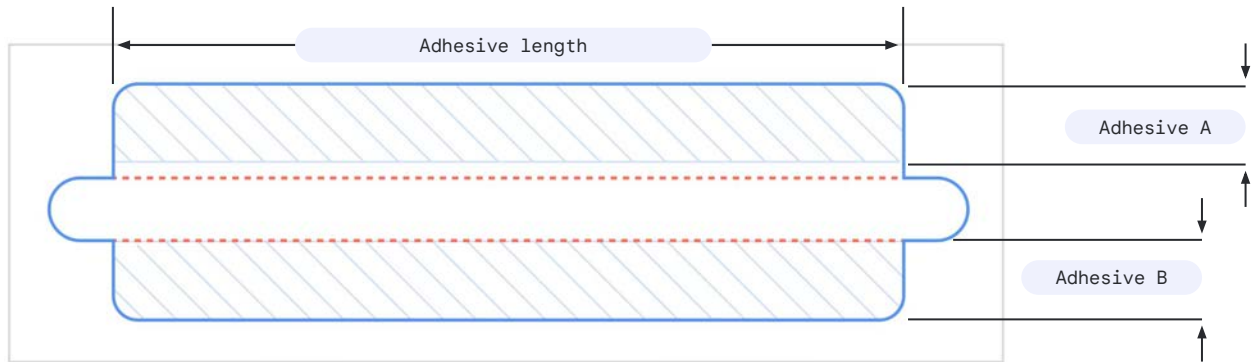

Geometry for protection and efficiency

- **Telescoping boxes:** Adhesive covers at least 50% of the lid's outer dimension.
- **RELF boxes:** Adhesive extends at least 75% of the box's outer dimension.
- **Adhesive width:** Minimum of 10mm for optimal adhesion during initial curing.

Accessibility: Pull tab design

- **Minimum size:** 8mm x 8mm is recommended to balance visibility and ease of grip.
- **Trade-offs:** Larger tabs may impact available space for box graphics.

Parametric design layout

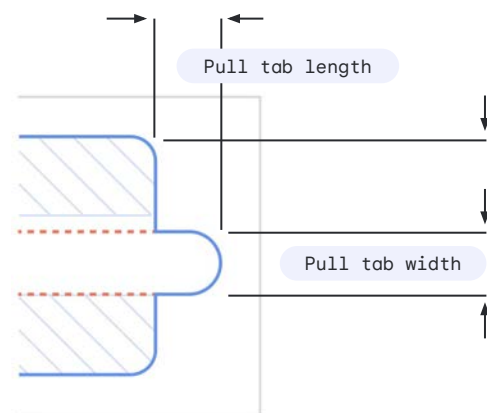

Closure labels

Deadening: Ensuring a smooth unboxing experience

A margin of deadened adhesive (non-sticky) with extra allowance on the closure side around the pull strip is crucial for a seamless opening experience.

Without it, telescoping box lids can become stuck, tuck-style closure may have residue, and pull tabs can have adhesive clinging to their edges, hindering functionality.

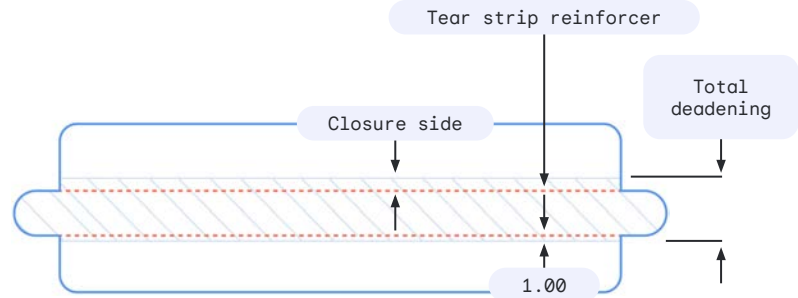

Deadening specifications:

- Minimum Width: 1.0mm, each side of the tear strip (tolerance +/- 0.5mm).
- Typical Extra Allowance Width: Approximately 2.0-2.5mm.

Starter slit

Our testing found that fiber-based labels do not require a starter slit to tear cleanly in reliability testing. Adding a starter slit may increase the risk of tabs accidentally ripping during handling.

This decision though should be tailored to the specific production context. If a starter slit is used, we recommend a length $\leq 1\text{mm}$.

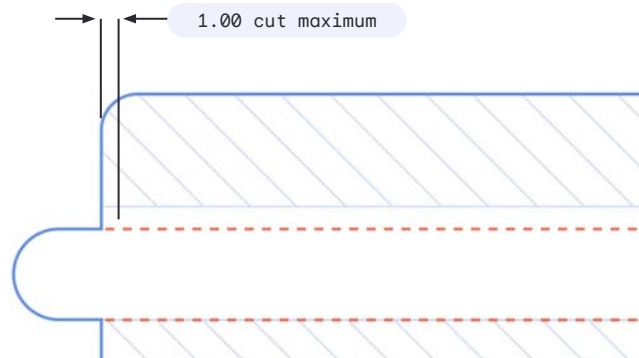

Closure labels

Key insights

Label face

The label paper must balance strength and ease of removal. Its grain should align with the tear direction to guide opening.

Tear strip reinforcer

This component requires especially high tear resistance. Translucent papers can offer this strength with minimal thickness, but their composition must be verified. Technical Data Sheets (TDS) and Material Safety Data Sheets (MSDS) should confirm that these papers are 100% plastic-free, with no regenerated cellulose.

Adhesive

A permanent adhesive is essential for tamper evidence. Thorough application with sufficient time and pressure ensures that part of the label remains on the box when opened.

Reliability

Labels must adhere securely but allow for a clean and continuous tear without tools. Vibration, drop, and environmental condition testing was used to verify label performance during shipping and handling. This testing also validates consistent, single-tear strip removal.

Label assembly

1. **Label face** (art paper)
2. **Tear strip reinforcer** (translucent paper)
3. **Adhesive**
4. **Release liner** (glassine paper)

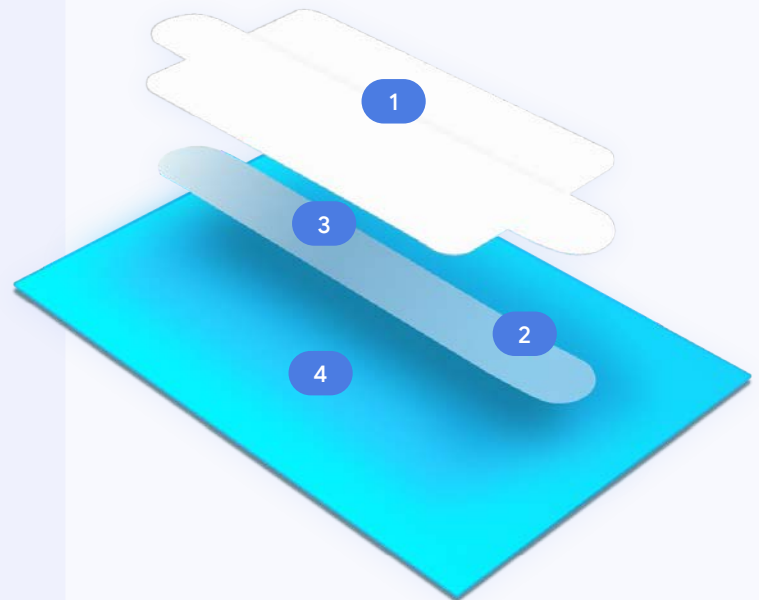

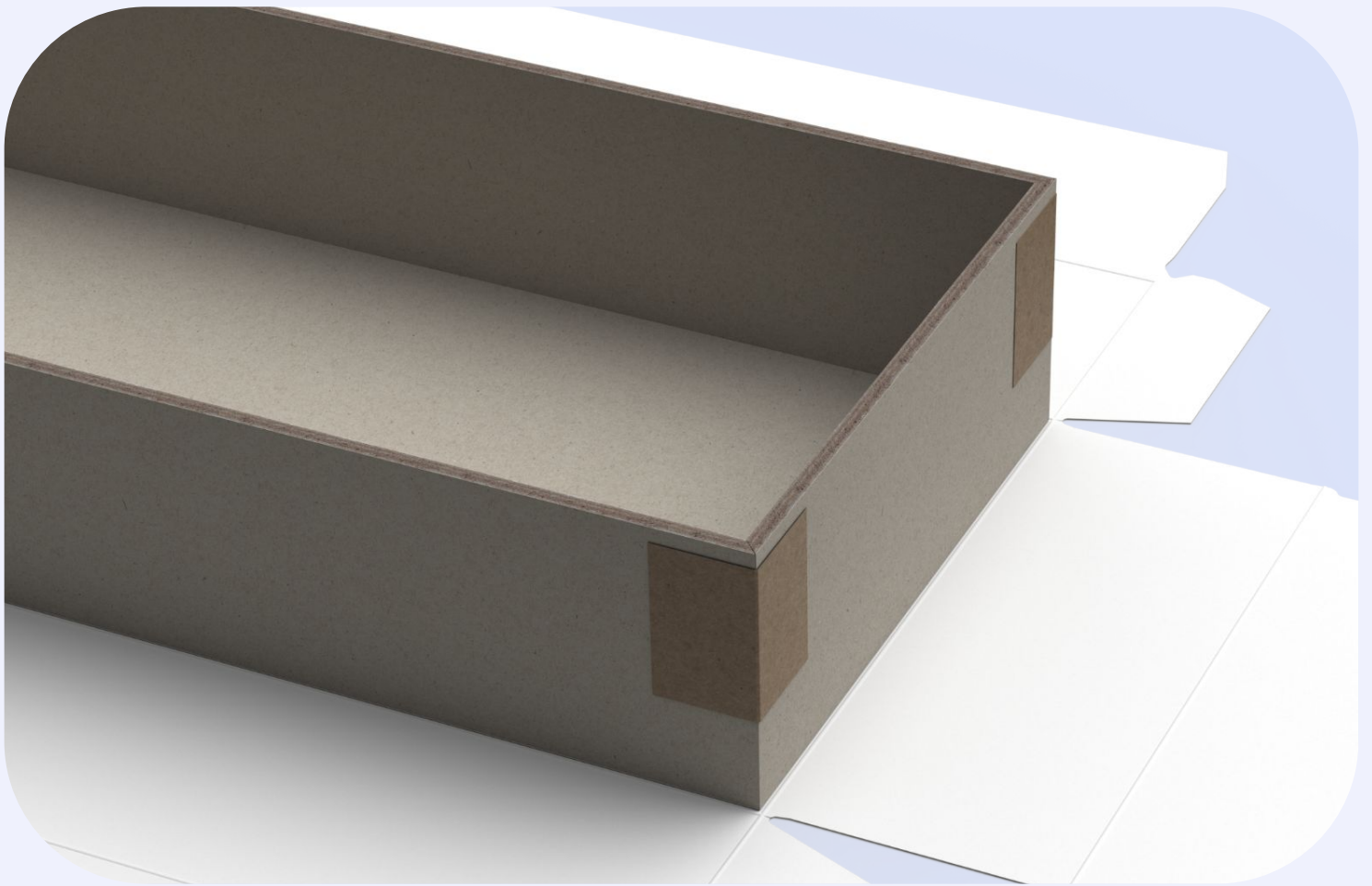

Paper tapes

Rigid box structures offer durable product protection.

Google's rigid telescoping boxes formerly used plastic corner tapes to provide tensile strength, but this also hindered recyclability.

Paper tapes

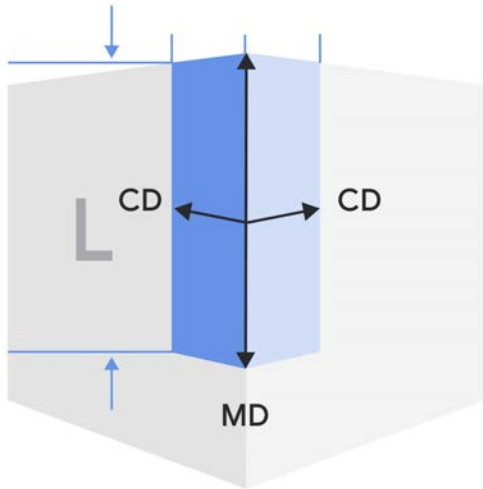

We successfully qualified Brown Kraft Billerud Korsnäs (BK) in 120gsm for its superior tensile energy absorption and passing our drop and vibration tests even for heavier products.

Our goal was to find a paper-based alternative that:

- Met or exceeded plastic tape corner tape performance.
- Was compatible with our suppliers' automated tape application process.
- Was readily available with a robust supply chain to avoid production disruptions.
- Had minimal thickness to prevent witness lines seen on the finished box.

A robust tape solution is essential to prevent corner tearing during a drop and ensure the vertical box walls stay perpendicular to the bottom panel. Higher tensile energy absorption provides better drop performance.

All papers used for tapes were qualified using tensile energy absorption in the Cross Direction (CD).

High fiber yield

BK Brown Kraft achieved a 99% fiber yield in repulpability testing, taking us closer to our goal of fully recyclable packaging.

Paper tapes

Key insights

Application:

We deboss our greyboard by 0.25mm in the corners to hide the tape.

Eliminating tape visibility provides a cleaner aesthetic and improves our ability to control consistency of box opening time.

Desirability:

We target a 2-5 second opening time for our rigid boxes in alignment with ISO 1156:2011 accessibility standards. This target is what we strive for, but some box designs may fall outside this range.





Hang tabs

Hang tabs offer benefits for both retail display and the overall customer experience:

- Hang tabs enable organized and eye-catching product displays creating visibility for consumer discovery and providing visual and tactile interaction.
- Robust hang tabs help deter theft and maintain product integrity.

Challenge

“Designing a hang tab that’s both strong and recyclable was a challenge, but it pushed us to explore innovative materials like molded fiber. We’re proud of the results and the positive impact it will have on the environment.”

- Miguel



Hang tabs

Putting fiber hang tabs to the test

To find plastic-free hang tab solutions that perform as well as their plastic counterparts in a retail context, we conducted testing to evaluate:



Strength and durability:

Pull force testing to failure and 20-day double-weight performance benchmarks to measure reliable product weight support.

Recyclability:

Repulpability tests to confirm that tabs break down seamlessly with other paper-based materials.

Manufacturing compatibility:

Confirming integration with existing vendor automation setups, avoiding costly retooling.

Design versatility:

Ensuring tabs could be folded parallel to the box surface minimizing wasted space within shipping cases.

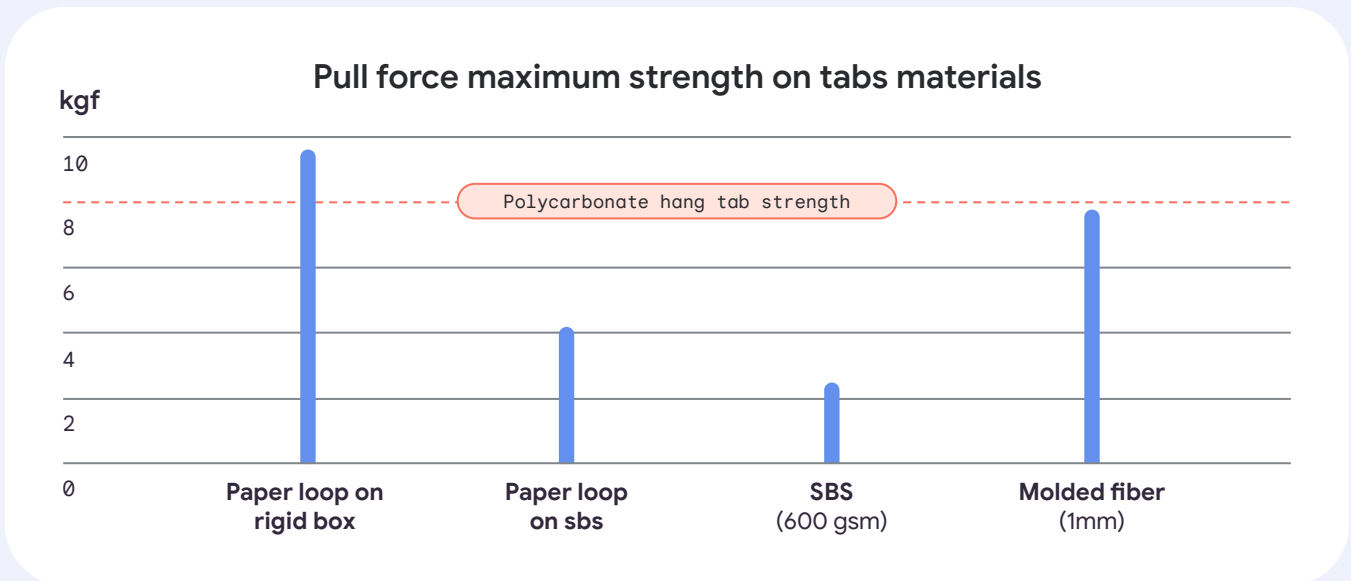

Hang tabs

Key insights ¹

We evaluated four hang tab solutions, including our legacy polycarbonate plastic solution as a control.



Threaded paper loop

Created by interlacing a single strip of paper to form a sturdy hanging solution, this option exhibited an impressive 10 kgf pull force when assembled on rigid box but failed repulpability tests, did not meet automation requirements, and carried increased assembly costs.



Double-coated SBS paper

This option is made from paperboard with a smooth coating on both sides for enhanced durability and printing clarity. It could not however, withstand our maximum pull force requirements.



Molded fiber

Demonstrated strong performance, closely matching the plastic control at nearly 8 kgf pull force, and excelled in other critical areas. We successfully tested options at both 1 mm thickness (heavier products) and 0.7 mm (lightweight solutions).

Hang tabs

Key insights ²

To move away from plastic we have adopted **molded fiber for our hang tab material**. Our team ultimately qualified the 2 thickness options (1 mm and 0.7 mm). This molded fiber material (composed of 55% bamboo pulp, 35% bagasse pulp, 10% wood pulp) delivered:

- Uncompromised performance that matched plastic in tensile strength tests, providing a reliable merchandising solution.
- Packaging that could be recycled as a single unit without separating the hang tab.
- A production-friendly solution with no retooling needed, enabling a smooth transition.



Placement

The tab is placed over the product's center of gravity (not the center of the box) to ensure a balanced display with euro-style compatibility across various peg designs.

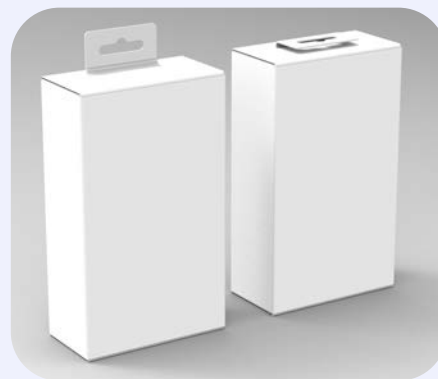

Hinge

A built-in hinge allows the tab to fold flat for efficient shipping.



Protective product wraps

First impressions matter.

Product wraps serve as the unsung heroes that ensure devices arrive in pristine condition. Choosing these materials requires careful consideration to achieve both superior product protection and improved recyclability.

Protective product wraps

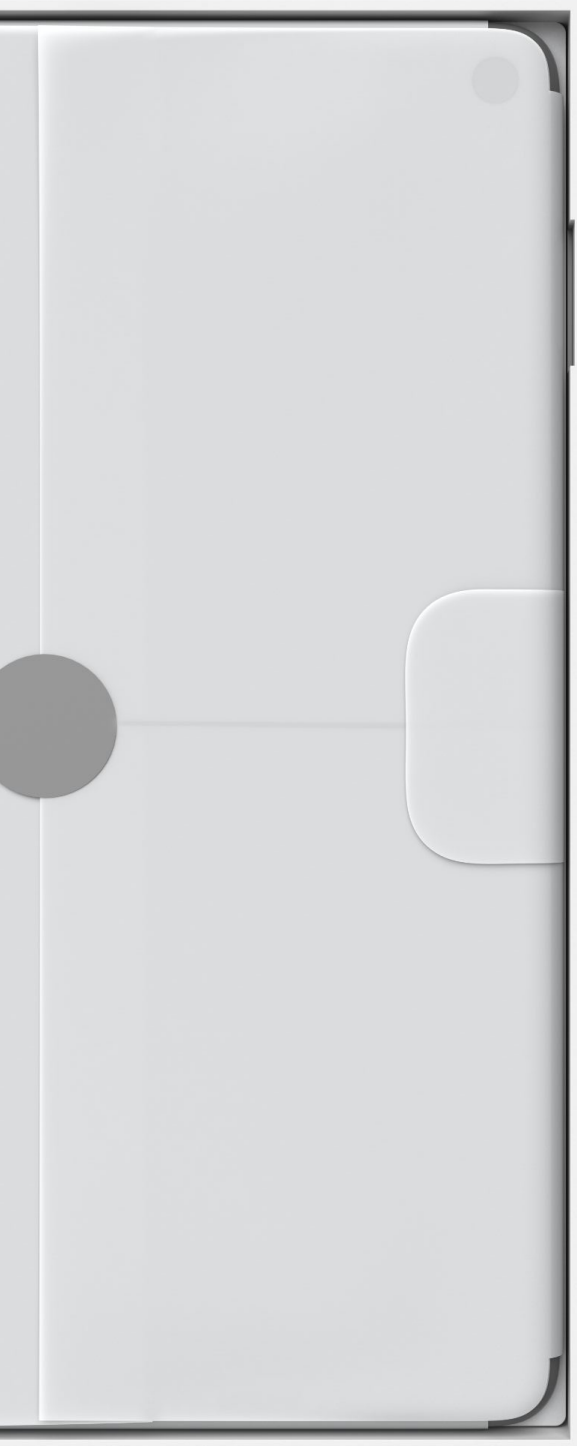

The functions of protective wraps in electronics packaging

Scratch and abrasion prevention

Protective wraps create a barrier, shielding product surfaces from scuffs and damage that can occur during transit and handling.

Dust and debris shield

These wraps maintain product cleanliness, preventing particles from settling within ports or openings.

Tamper-evident design

For consumers, an intact protective wrap acts as a reassuring sign of an untouched, brand-new product.

Gift-like unboxing

The right material elevates the unboxing process. Choosing a protective material also for its visual and tactile qualities can elevate the excitement of unboxing a new product.

Enhanced accessibility

Product wraps can incorporate pull tabs or tactile signifiers (like textures or raised areas) to create a more intuitive, accessible unboxing process for all users.

Protective product wraps



Testing fiber-based solutions

We explored sustainable fiber-based solutions for several critical packaging applications.

Our multi-pronged assessment focused on:

- **Abrasion resistance and surface protection:** Sutherland Rub tests (up to 100 strokes at 4lbs) against common product enclosure materials helped measure a wrap material's effectiveness.
- **Dust ingress prevention:** Carefully evaluated to ensure a tight, protective seal.
- **Ease of manipulation:** We studied how smoothly materials were removed and their suitability for wrapping various device shapes.
- **Consumer experience:** Assessing visual appeal, tactility, and contribution to "unboxing" excitement.
- **Recyclability & compatibility:** We prioritized options more compatible with paper/cardboard waste streams.



Above: Abrasion on a common enclosure material using a Sutherland Rub tester.

Protective product wraps

Key insights

Our investigations have shown that fiber-based wraps can provide the protective qualities crucial for consumer electronics without relying on single-use plastics. They can also create an enjoyable unboxing experience. We evaluated many materials and identified **4 options** that can be effectively used for different situations requiring a protective wrap.

Supercalendered paper (glassine)

Scored well overall, except for average dust prevention. Suitable for general product/device wrapping.

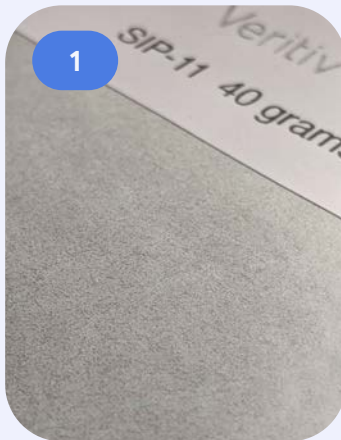

Coated wrapping paper

Performed better for dust, but overall average performance. A viable option for select use cases that do not require translucency.

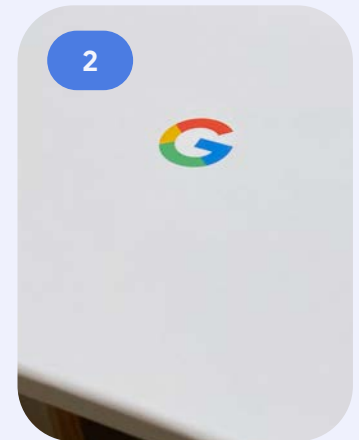

Translucent paper

Ideal for bundling internal packaging documentation and adding an extra layer of protection.

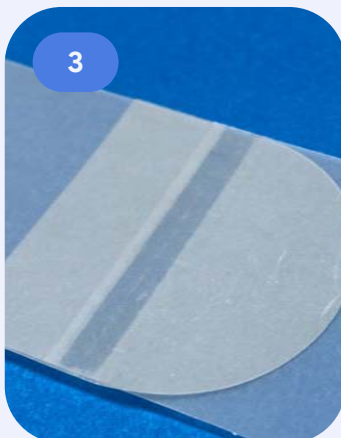

Low density filter paper

Strong all-around performer and soft-touch texture. However, its slightly higher cost makes it best suited for when product surfaces demand maximum protection.

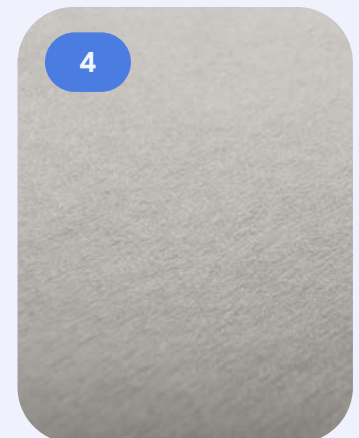

Protective product wraps

Minimal adhesion

We prioritize product wraps that adhere to themselves or, even better, require no adhesive at all. When that isn't possible for specific products, applying wraps adjacent to packaging parts rather than the product itself can be an effective approach.

For our Pixel phones, we've chosen to adhere a wrap to the product, creating a more accessible design and an improved unboxing experience. In these cases we specify materials that eliminate unwanted residue.

Shown:
Pixel 8 Pro packaging,
Fall 2023





Inbox trays

Thermoformed PET trays have long been a staple to ensure higher value products are fully protected, but molded fiber offers exciting potential to merge recyclability advantages with premium functionality.

Molded fiber has cushioning properties that prevent damage during shipping and handling. Customizable shapes provide a secure fit, even for irregularly shaped items. Additionally, the tactile qualities of molded fiber may enhance the unboxing experience and product presentation.

Challenge

* * * * *

“While thermoformed plastic trays have their merits, we’ve found that molded fiber offers comparable protection with the added benefits of recyclability and a more natural aesthetic.”

- Rob



Inbox trays

Tray types: Hinged trays

Benefits

- Precise cuts ensure a visually refined presentation and seamless integration with the surrounding structure.
- Structural stability minimizes warping, ensuring reliable product protection.
- High customization enables features like mirrored cavity geometry that can reinforce hinged panels for added strength and support.
- **Hinge style options**
 - Molded hinges are a cost-effective option integrating directly into the molded pulp tool during manufacturing and offering superior strength with slightly less precise dimensional accuracy after folding.
 - Post die-cut hinges, created by V-cutting pre-molded trays, deliver higher dimensional accuracy for a precise fold. They may have slightly lower strength compared to molded hinges and potentially increase cost.

Drawbacks

- Hinges require careful design to prevent tearing during initial and/or repeated folding.
- Hinged panels increase blank size (i.e. footprint) of a flat part during molding, which may increase part cost and reduce cavitation.



Inbox trays

Tray types: Skirted trays



Benefits

- High dimensional precision across production runs.
- Robust, stiff structure withstands handling and stacking.
- Potentially lower cost compared to hinged designs.
- Maximizes protective features while minimizing space within the package.

Drawbacks

- Draft angles can create a visual gap between the tray and enclosing structure.
- Risk of sidewall movement/flexing within the package without sufficient support.

Inbox trays

Tray types: Flanged trays



Benefits

- Sharp cuts enhance visual appeal and fit within surrounding structures.
- Material efficient design option.

Drawbacks

- Large, flat surfaces are more susceptible to warping especially under load and in hot and humid conditions.
- Exposed tray edges may be more prone to scratches or dents.
- Lack of vertical walls increases the risk of tray (and therefore product) movement during shipping if the tray is not well secured.

Inbox trays

Considerations for molded fiber trays

Strong supply chain partnerships

This ensures cost-effective solutions and reliable high-volume production. We analyzed supplier capabilities to inform tray designs.

Structural and visual optimization

- **Clean edges, secure fit:**
Precise tray cuts enhance ease of removal, ensure stackability, and create a visually refined presentation.
- **Product interaction:**
Subtle tray curvature can reflect product form, guiding natural placement and enhancing visual harmony.

Hinge functionality

We evaluated trade-offs between molded hinges and V-miter options based on cost, precision, and overall product presentation.

Consumer recycling

Adding recycling symbols on the trays promote responsible disposal.



Inbox trays

Key insights ¹

Maintaining consistency across device trays ensures stability and visual cohesion within a product package design.

Using different tray designs could contribute to reliability issues. For example, if one tray has more freedom of movement, it could cause undue surface contact with the device.



Inbox trays

Key insights ²

Tray cavity radii

Thoughtful design choices can balance a clean and visually appealing appearance with optimal functionality.

Because product abrasion risks are inherently higher with fiber-based materials compared to plastic, we recommend that radii transitioning from flat tray surfaces into product cavities be 5mm or less.

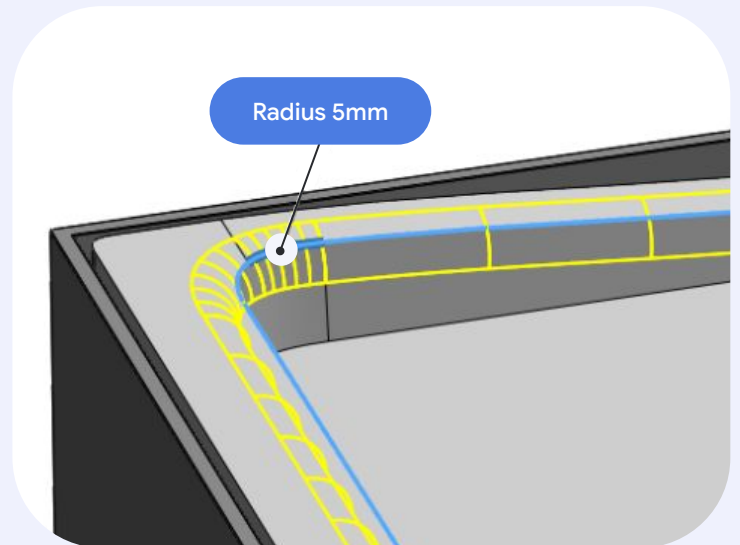

Tray marking

Including visible recycling logos on molded fiber trays can encourage more consumer recycling.



Inbox trays

Key insights ³

Pulp fiber recipes

Cosmetic molded pulp provides a smooth, consistent surface finish and can be molded into a wide variety of shapes and geometry for cosmetically significant trays. Different molded pulp manufacturing processes have varying degrees of finished part surface quality.

Once a manufacturing process is selected, we recommend using a standard slurry recipe to streamline production, control costs, and ensure a consistent, high-quality finish. Maintaining a standard recipe across multiple products reduces changeover and cleaning requirements during manufacturing.

For purely structural trays, consider using recycled materials like old corrugated cardboard / container (OCC) for enhanced strength, higher recycled content and lower part cost compared to cosmetic molded pulp solutions. Materials like OCC typically produce parts with less desirable surface finishes, but have lower density and allow for thicker walls. This trade off has advantages for shipping and assembly, but may not be appropriate for product contact or consumer facing surfaces.



Inbox trays

Key insights ⁴

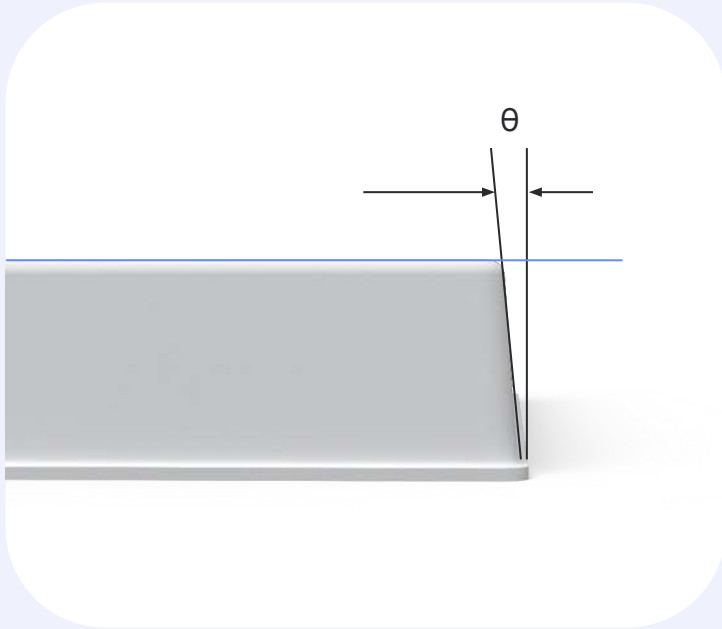

Precise fit

Steep draft angles can help provide a refined aesthetic, but come at the expense of manufacturability and (in most cases) surface quality. On non-product contact surfaces, we recommend that draft angles ideally not exceed 4°. This allows also for a snug fit within the surrounding packaging, minimizing gaps and enhancing stability and without sacrificing yield or part quality.

To further minimize gaps between inbox trays and the outer box, consider flanged or hinged trays.



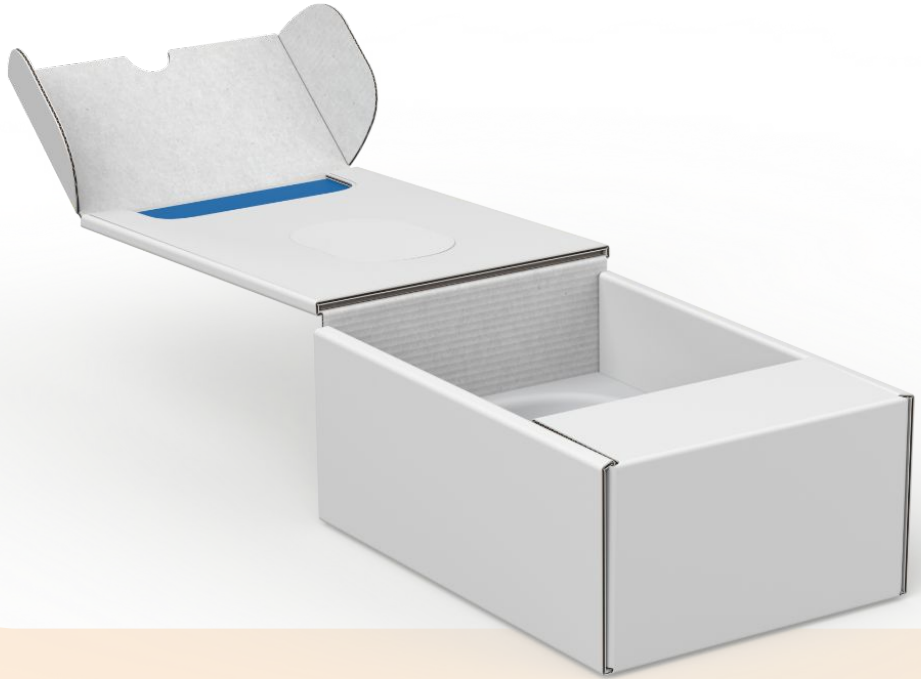

Section 3.0

Structural design

In this section

Telescoping box →

Roll end lock front box →

Tuck top box →

Isn't it just a box?

At Google, we carefully choose packaging structures to meet the unique needs of each product.

Our primary focus is on four versatile designs, the **Telescoping Box (Rigid and Paperboard)**, the **Roll End Lock Front Box**, and the **Tuck Top Box**. Each of these is tailored for different types of product and different end user experiences.

Challenge

* * * * *

“Structural design is like puzzle for me. Solving for sustainability just adds to the fun!”

- Cole



Telescoping box

(Rigid and paperboard)

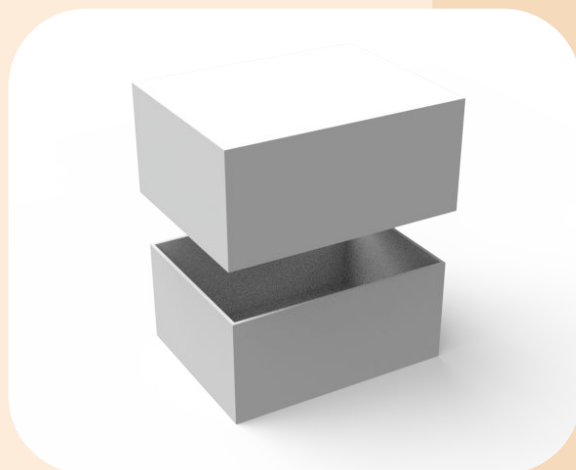

- This box type features an elegant and classic aesthetic with clean lines ideal for showcasing higher value products upon opening. A telescoping lid offers a simple opening and closing mechanism. Custom inserts and collars can be added for a tailored unboxing experience.
- Provides excellent structural stability and a secure fit. Rigid versions may occupy more recycling bin space due to its non-collapsible form. Paperboard versions are more easily broken down to enable more efficient recycling (i.e. made to lay flat).
- Rigid box versions are typically constructed with greyboard (a high-strength recycled board). Paper tape is applied in the corners, and the box is wrapped in a paper top sheet. Various alternatives to greyboard exist, including the use of corrugated, laminates, and more. Paperboard is commonly used for lighter products, offering a smooth surface for printing. For heavier items, corrugated inserts (E or F flute) can help provide additional structural support adding rigidity and shock absorption.
- Some aspect ratios in this format present limitations. For example, telescoping structures with very large footprints can become difficult if not impossible to open with one hand and deep boxes can take a long time to open especially if the product is lightweight.
- While many suppliers can automate construction to reduce cost and tighten assembly tolerances, it is not universal. Handmade versions may involve more complex assembly.
- Where possible, pre-assembling in-box components in the rigid box structure can reduce logistical and manufacturing costs.

Roll end lock front box

(RELF)

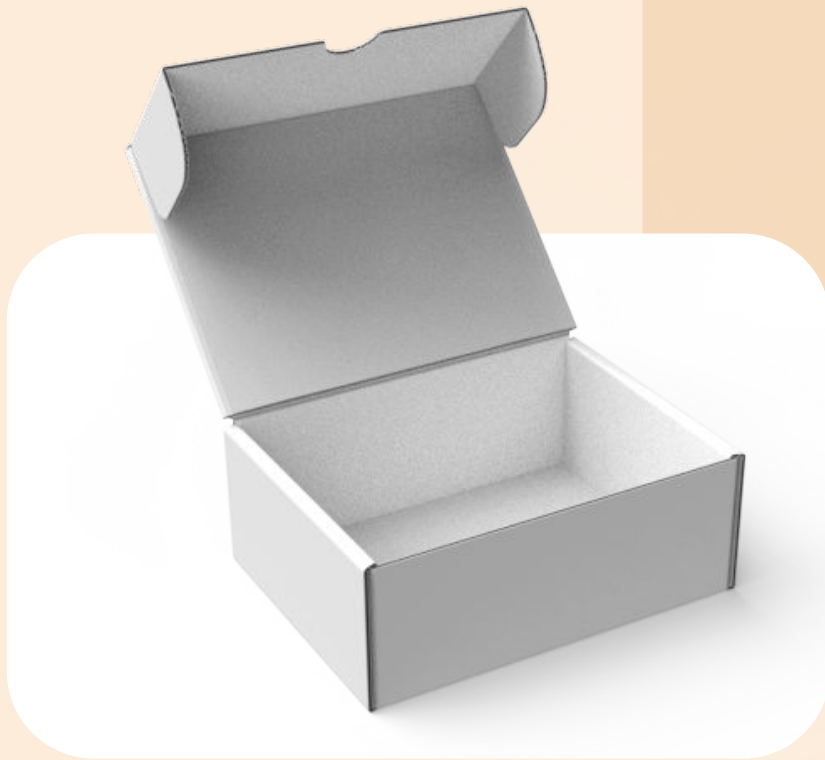

- A versatile structure featuring a front panel with interlocking tabs for closure. The design offers a balance between protection, familiar opening and easy assembly. Can be designed to break down easily for more efficient recycling.
- Intuitive to open and can often be re-closed if needed. Effective where single-handed opening is desired.
- They come in a wide range of sizes, but may have limitations for very deep products. Larger blank sizes can easily be broken into multiple panels to accommodate equipment limitations. Thoughtful placement of seams helps maintain good aesthetics. Alternative designs like the Econo Roll End Lock Front Box are available.
- Constructed from materials such as paperboards or various corrugates. Material choice and/or reinforcement should be informed by intended use, product weight and scale.

Tuck top box



- Simple, functional appearance featuring a top flap that tucks into the box that is easy to open and close.
- Highly cost-effective and widely used for smaller accessories and lower priced products offering basic protection and easy assembly.
- Highly efficient to manufacture and ship flat.



Challenge

* * * * *

“Time is of the essence for our planet and it just makes sense to share knowledge. We have a collective goal.”

- David



The power of collaboration

Innovation can come from anyone or anywhere, but industry transformation involves everyone. We believe that by sharing our experiences, findings, and challenges, we can catalyze progress in our industry and others. What we’ve achieved isn’t perfect, but we hope it’s helpful and we’re eager to learn from solutions that others will create.

We’re excited to foster a community on our collective journey to create a future with sustainable products and services. By sharing design and engineering excellence, we believe we can protect the health of our planet and everyone on it.

Let’s collaborate to make that goal a reality.
packaging_sustainability@google.com

Glossary of terms



Accessibility

Designing for users with varying abilities and dexterity.

Cavitation

The number of cavities present in a molding tool. The cavitation number directly tells the expected number of parts produced each time the tool is cycled.

Closure label

A label with adhesive, used to secure packaging and provide tamper evidence.

Debossed

A technique to create a recessed design in paperboard, often used for logo placement.

Deinking

The removal of ink from paper during recycling to create clean pulp.

EVA glue

Ethylene-Vinyl Acetate is an adhesive used in paper tapes.

Greyboard

A high-density board with good stiffness and strength. Without fluting it's thickness is more dimensionally stable compared to corrugated. Its ideal as a cost-effective substrate for a wide-range of uses where heft and rigidity are needed. It can be made from 100% recycled fiber and is typically covered in a paper top sheet to provide a stable, finished appearance.

Hang tab

Part of packaging that allows it to be displayed on hooks or shelves.

Molded fiber

Shaped paper pulp, often made from recycled materials, used for trays and inserts.

OCC

Old Corrugated Cardboard / Container, a common recycled material used in packaging.

PET

Polyethylene Terephthalate, a common plastic used for thermoformed trays and corner tapes in hardware packaging.

Glossary of terms



PP lamination

Polypropylene lamination, a plastic film applied to paper-based packaging.

Recyclability

The ability of a material to be disposed of in a municipal recycling system and be identified, properly sorted, and ultimately be reprocessed and reused.

RELF box

Roll End Lock Front, a type of folding carton with tuck-in tabs.

Repulpability

The ability of a material to break down into fibers during the paper recycling process.

Rigid box

A premium packaging structure, often used for electronics, typically made from greyboard.

Reliability testing

A suite of tests (vibration, drop, environmental conditioning and more) to simulate supply chain stresses.

Score / fold cracking

Damage at folded edges of paperboard.

Scuffing

Surface damage caused by abrasion.

Stickies

Small, tacky contaminants in recycled pulp that can disrupt papermaking equipment.

Sustainability

The practice of design, engineering and operational activities to create positive environmental outcomes.

Tensile energy absorption

The amount of energy a material can absorb before breaking.

Tensile strength

A material's resistance to breaking under tension.

Telescoping box

Two-piece rigid box where the lid slides over the base.

User experience

A user's journey of discovering, opening, and disposing of product packaging.

Visual appeal

The overall aesthetic of the packaging, including color, graphics, and finish.

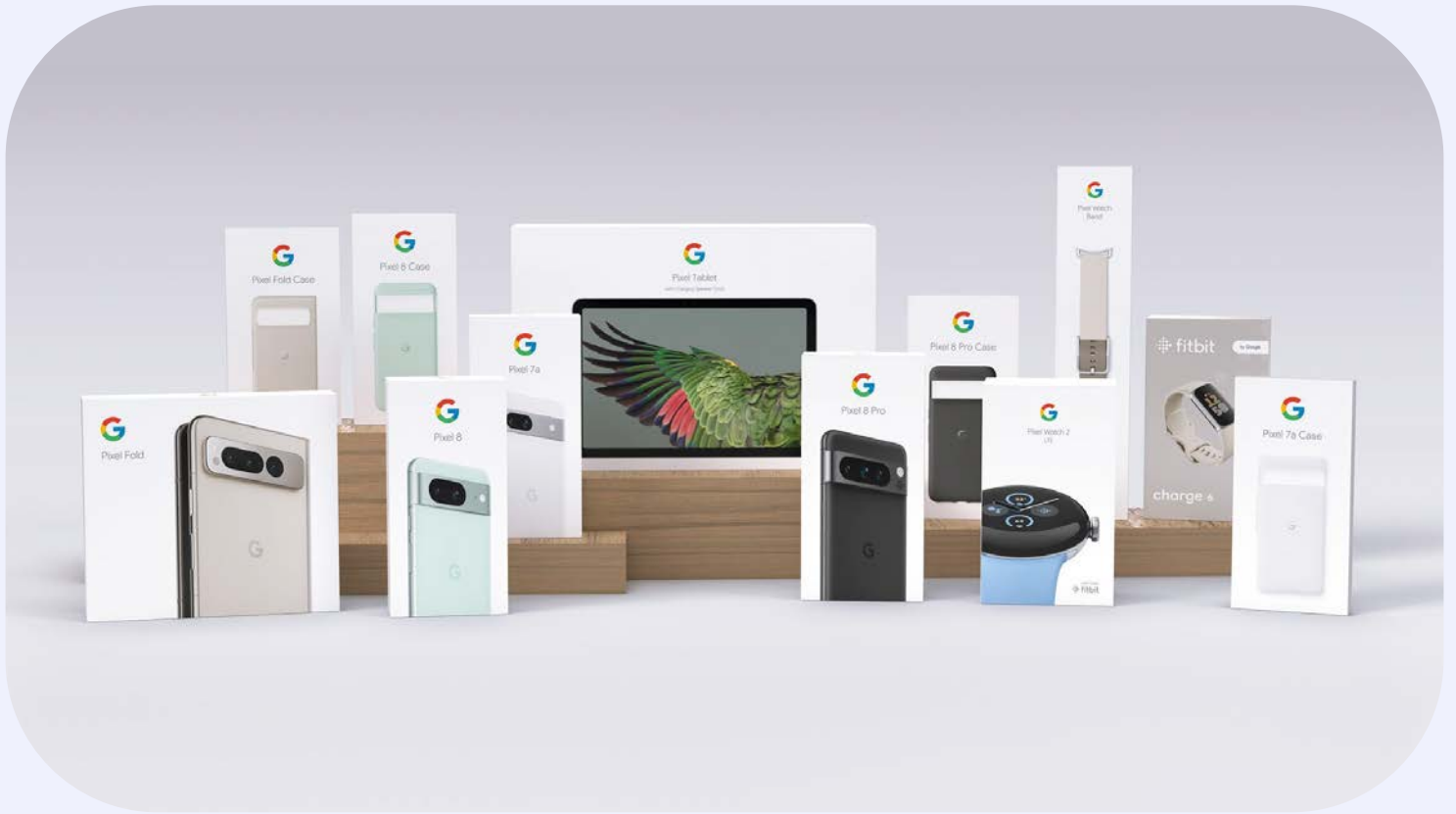

Plastic free material library

Challenge

* * * * *

“Our material library reflects the deep collaboration and shared spirit of innovation that our suppliers have brought to our sustainable packaging solutions”

- Abhinav



Materials

Main part category type	Sub part component/ category type	Supplier name	Grade name
Rigid Box	Top Sheet	HuaXia SunPaper	157gsm
Rigid Box		JinTian	1200gsm
Rigid Box	Greyboard	Sichuan Hongtu Scenery Environmental Technology Co., LTD	1050gsm
Rigid Box		Sen He Paper Co.,Ltd.	950gsm
Rigid Box	Paper Tape	BillerudKorsnäs (BK)	120gsm Brown
Various	UV Coating and inks	Megami	LH-GE Series (inks) LH-GE Matte OP (Coating)
RELF Retail Box	Top Sheet	HuaXia SunPaper	250gsm
RELF Retail Box	Single Face Corrugate	Various	F-flute
Folding carton retail box	Paperboard	HuaXia SunPaper	300gsm
Folding carton retail box	Paperboard	HuaXia SunPaper	350gsm
Corrugated inserts	Top Sheet	HuaXia SunPaper	250gsm

Main part category type	Sub part component/ category type	Supplier name	Grade name
Corrugated inserts		Various	E-flute (100g Kraft/200g Kraft)
Corrugated inserts	Single Face Corrugate	Various	F-flute 175g #1 White (100g Kraft/200g Kraft)
Corrugated inserts		Various	G-flute (120 Kraft/180g white kraft)
Cable wraps, complex folding inserts	Paperboard inserts		Starblanc C2S Bristol 250gsm
Cable wraps, complex folding inserts	Paperboard inserts	HuaXia SunPaper	Starblanc C2S Bristol 300gsm
Cable wraps, complex folding inserts	Paperboard inserts		Starblanc C2S Bristol 350gsm

Materials (continued)

Molded fiber	Fiber composition	Thickness
Cosmetic molded fiber	65% Bamboo pulp 35% Bagasse pulp	0.60mm- 1.20mm
Cosmetic molded fiber	55% Bamboo pulp 35% Bagasse pulp 10% Wood pulp	1.0mm
Kraft molded fiber	100% Old Corrugated Containers	1.80-3.50mm

Protective wraps	Supplier name	Grade name
Documentation band wraps	Arjowiggins	GT-63-HM
Product wrapping	SIP	SIP-11
Box closure labels	UPM	
Screen protectors	Sun	128gsm ArtPaper
Screen protectors	Meixin	MXPR-0010AU

Packaging converter supplier list

Name	Product(s) for Google	Company website
Cymmetrik	Labels, Screen Films.	https://www.cymmetrik.com
Intramedia	Printing bundle, Molded fiber, Boxes.	https://www.imedia.com.tw
Lihua/Hyperpack	Boxes, Corrugated Cartons, Printed Bundle Assembly and Molded Fiber.	http://www.lihua-printing.com
MYS	Boxes, Corrugated Cartons, High Frequency Welding in Boxes.	https://www.szmys.com
Paishing	Boxes, Corrugated Cartons, Printed Bundle Assembly, Molded Fiber.	http://www.paishing.com
YUTO	Boxes, Corrugated Cartons, Printing Bundle Assembly.	https://www.szyuto.com

Acknowledgements

Our work on plastic-free packaging has been made possible by the talent, creativity, and dedication of many individuals from across Google and our suppliers.

Contributors to this include Google's packaging engineering, design, operations, and sustainability strategy teams.



Endnotes

1. [The world's plastic pollution crisis, explained.](#)
National Geographic, 2024
2. [Earth Day 2022.](#) Public Opinion on Climate Change.
3. Per [ISO 0472-2013.](#) Plastic, noun. Material which contains as an essential ingredient a high polymer and which, at some stage in its processing into finished products, can be shaped by flow.
4. Note 1 to entry: Elastomeric materials, which are also shaped by flow, are not considered to be plastics.

Google

Plastic Free Packaging Design Guide

We'd love to hear about ways you've found this guide helpful, technical questions you have or suggestions to improve it.

Let us know at packaging_sustainability@google.com

Google is driving sustainability innovation in many different areas across our products and operations.

Check out the latest news and progress at:
sustainability.google