

Electronics®

Removing noise from low-level signals: page 80

Higher power from avalanche diodes: page 96

Low-cost video recording: page 110

July 8, 1968

\$1.00

A McGraw-Hill Publication

Below: Infrared sets off flash
from semiconductor crystals, page 104

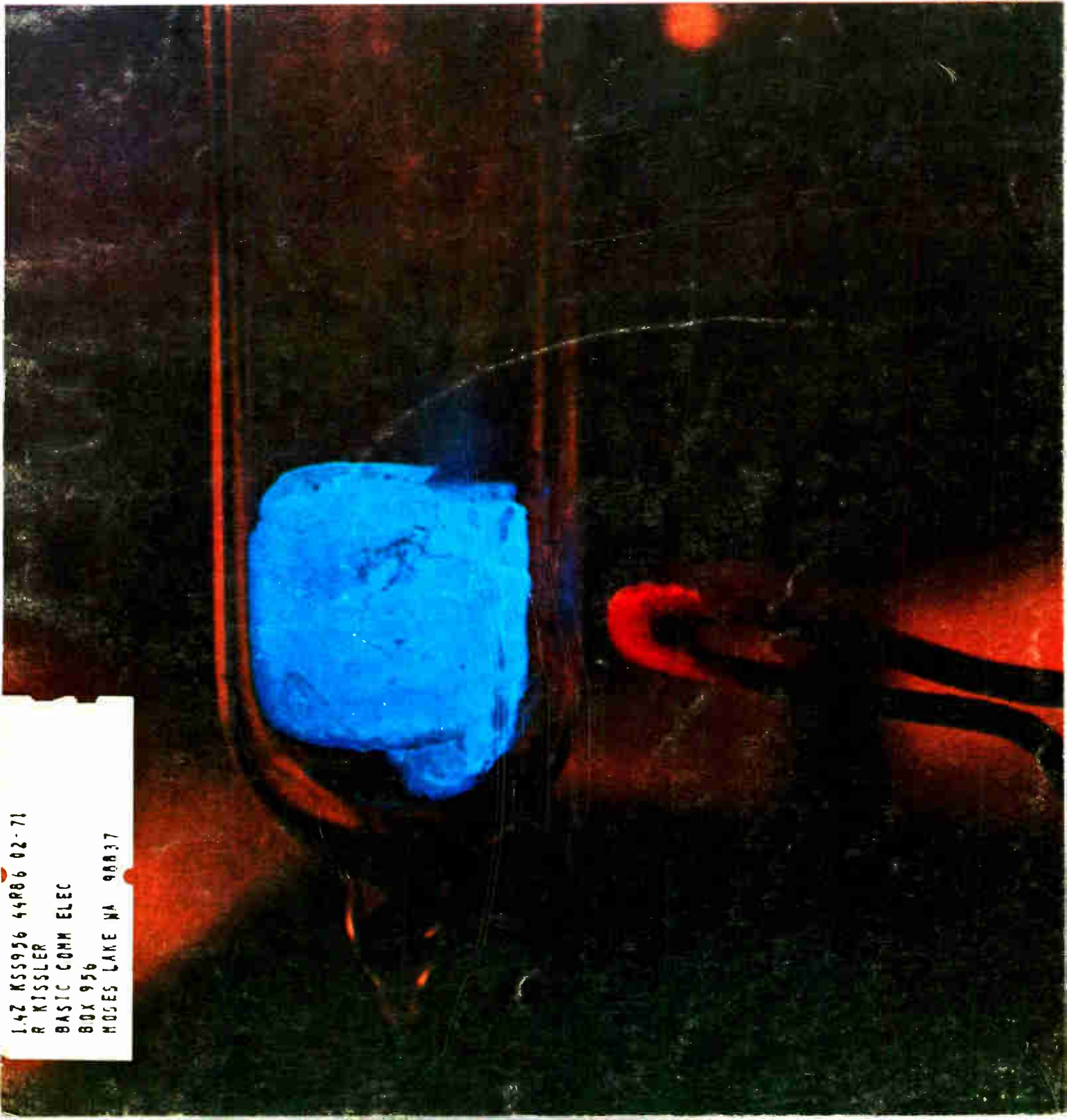

1.4Z K55956 4486 02-71
R KISSLER
BASIC COMM ELEC
BOX 956
MOSES LAKE WA 98837

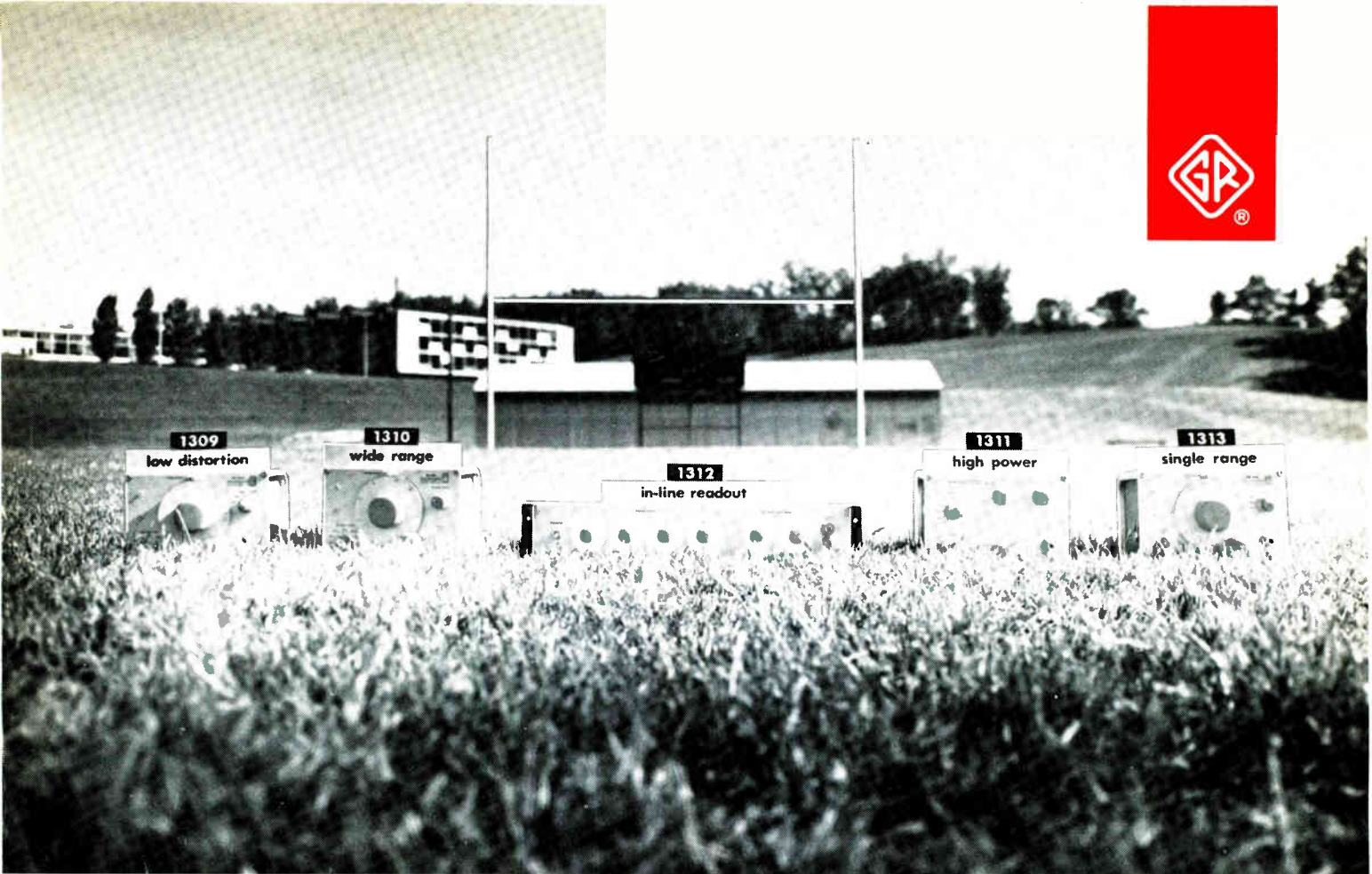

Tackle your signal-source problems with this line

No one calls the signals exactly the way you do; and different applications require different features in signal source. That's why we offer you a whole line of sync-able RC oscillators — so you can match your signal source to your needs.

If you are measuring distortion, low-level noise, or transient response, a low-distortion test signal is your primary concern; the Type 1309 oscillator is for you. Total harmonic distortion is specified at $\leq 0.05\%$, and it is typically much lower. The 1309 also offers sine- and square-wave outputs, a calibrated attenuator, and a 10 Hz-to-100 kHz frequency range . . . all for \$325.

Wide range is the big feature of the 1310. This oscillator spans a frequency range of 2 Hz to 2 MHz in six decade ranges. Its flat output (> 20 V open circuit) makes it ideal for frequency-response measurements, and its excellent resolution and stability permit its use for measurement of narrow-band devices. Price . . . \$325.

With **high-output power**, the 1311 is tailor-made for use as a bridge oscillator or for driving low-impedance devices like acoustic transducers. It has a 1-watt, transformer-coupled output at 11 fixed frequencies from 50 Hz to 10 kHz, with a Δf control for $\pm 2\%$ adjustment. Price . . . \$260.

Production applications require **easy settability and good repeatability**. The 1312 decade oscillator fits on both counts. This oscillator has in-line readout with automatically positioned decimal point and unit of measurement. Thus the frequency is easy to set . . . virtually impossible to misread . . . precisely reset. It has a 10 Hz-to-1MHz frequency range with > 20 -V open-circuit output . . . all for \$415.

Other production-line testing requires that devices such as amplifiers and loudspeakers be response- and distortion-tested quickly and without being overdriven. The 1313 oscillator is ideal for this use. Its 10 Hz-to-50kHz frequency range is covered on one dial, so you don't have to switch ranges. This means **fast testing, no transients, and unambiguous dial, and no range switch to replace periodically** because of constant use. Price . . . \$325.

All these oscillators are equipped with the GR-developed sync jack to lock the instrument to an external source or to provide a triggering signal for counters, scopes, or other devices. All provide high, flat output and an unusual combination of performance, reliability, and economy that make each oscillator ideally suited for particular applications. So you call the play: choose the features you need in a signal source. Then choose the GR oscillator with those features.

For more information, call your nearest GR office, or write General Radio, W. Concord, Mass. 01781: Telephone (617) 369-4400. In Europe, Postfach 124, CH8034, Zurich 34, Switzerland.

Prices apply only in U.S.A.

GENERAL RADIO

Circle 900 on reader service card

- 140A Plug-in Oscilloscope
- 141A Variable Persistence Oscilloscope
- 185 CHN Analyzer
- 310A, 312A Wave Analyzers
- 313A Tracking Oscillator
- 340B Noise Figure Meters
- 400E AC-to-DC Converter
- 400EL High-Accuracy AC Voltmeter
- 410C Electronic Voltmeter
- 411A RF Millivoltmeter
- 412A Voltmeter, Ammeter, Ohmmeter
- 415B, 415E, 416B Standing Wave Ratio Meter
- 419A DC Null Voltmeter
- 428B Clip-on DC Milliammeter
- 431C Microwave Power Meter
- 500B Frequency Meter
- 562A Digital Recorder
- 581A D/A Converter
- 675A Sweeping Signal Generator
- 775, 776 Automatic Preparative Gas Chromatograph
- 780-7 Patient Monitor
- 8551B/851B Spectrum Analyzer
- 1416A Swept Frequency Oscilloscope Indicator
- 1782A Oscilloscope Display Scanner
- 2010A, 2012A Data Acquisition Systems*
- 2116A, 2115A, 2114A Computers*
- 2801A Quartz Thermometer
- 3300A Function Generator
- 3400A RMS Voltmeter
- 3406A Broadband Sampling Voltmeter
- 3430A DC Voltage Recorder
- 3439A, 3440A Plug-in Digital Voltmeters*
- 3460B Digital Meter
- 3461A AC/Ohms Converter, DC Preamplifier*
- 4815A AC/Ohms Converter, DC Preamplifier*
- 5211A, 5212A Electronic Counters*
- 5214L Preset Counter*

- 5275A Time Interval Counter*
- 5280A Reversible Counter*
- 5400A Nuclear Multichannel Analyzer
- 5552A Spectrum Scanner
- 5751B Research Gas Chromatograph
- 8051A Loudness Analyzer
- 7561A, 7562A Loudness Analyzers
- 8405A Loudness Analyzer

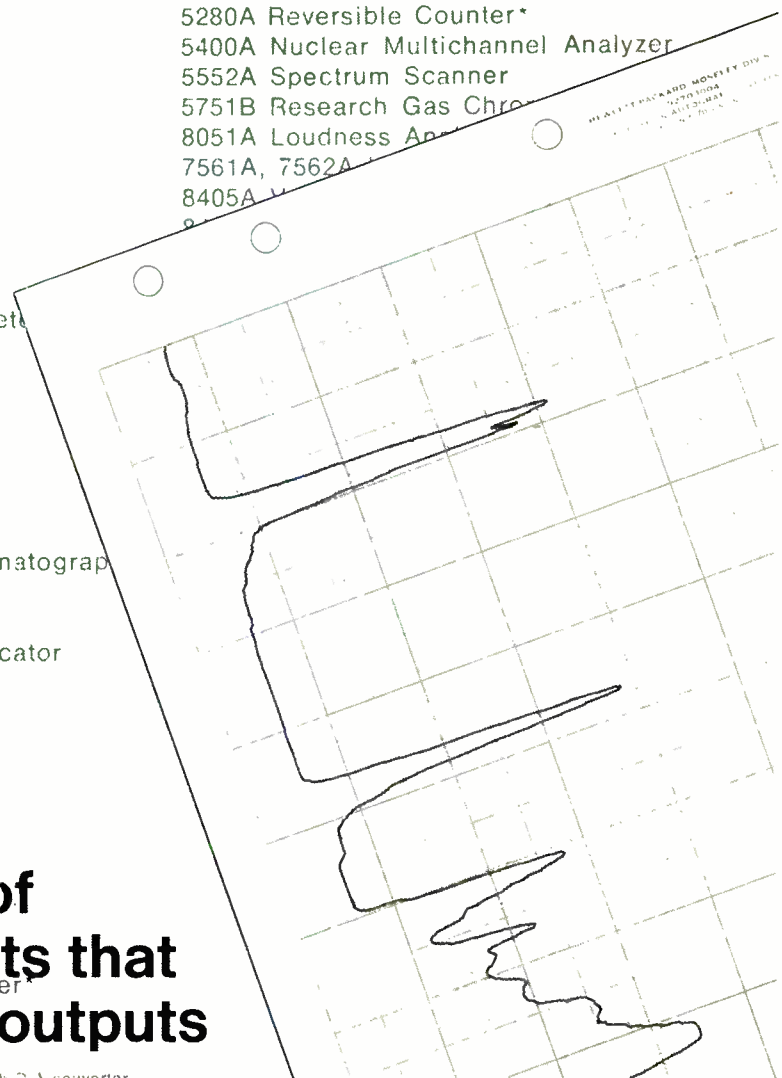

These are some of the HP instruments that provide recorder outputs

*with D-A converter

Wouldn't a graphic recorder make your job easier?

It probably would. Because Hewlett-Packard X-Y and strip-chart recorders connect to a wide variety of precision measuring instruments to give you a permanent graphic display of your measurements. Plots and graphs let you analyze your results more thoroughly, give you permanent records for later reference and allow you to make comparison studies of several measurements.

You might be surprised how many measurements can be recorded by a simple connection to your instrument.

To find out how a graphic recorder can improve the information value of your measurements, call your local HP field engineer or write Hewlett-Packard, Palo Alto, Calif. 94304; Europe: 54 Route des Acacias, Geneva.

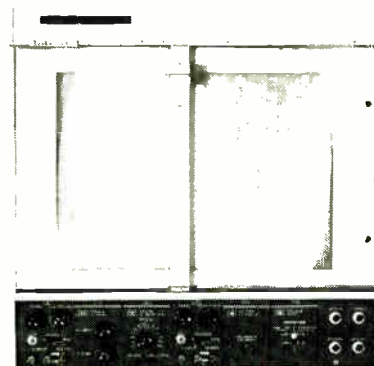

GRAPHIC RECORDERS

11807

add sweep and offset

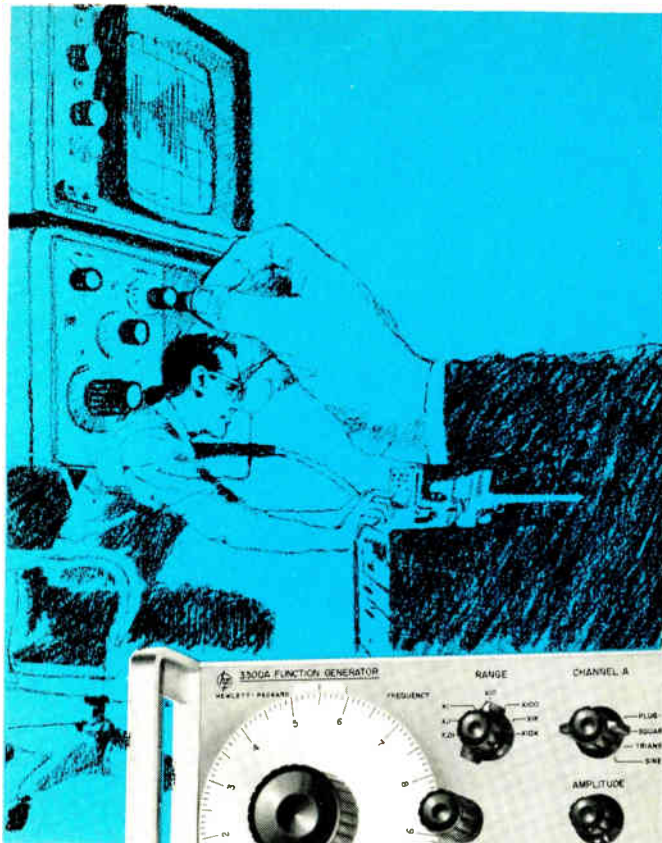

to Your 3300A Function Generator

Get One Source for Any Waveform to 100 kHz

Linear sweep in decade steps over a 0.01 Hz to 100 kHz—sine, square and triangular waveforms—variable dc offset for each function including sawtooth—from one source, the hp 3304A Sweep/Offset Plug-in and the 3300A Function Generator.

Manual Sweep: start frequency and sweep width are individually adjustable over at least one decade for easy location of sweep range. Swept frequencies and the sawtooth are simultaneously available for display on oscilloscope or recorder.

Programmable Sweep: External sweeping or programming over a decade of frequency is possible with 0 to -10 V with the basic function generator.

DC Offset: Use the dc offset with any waveform— ± 16 Vdc range with a ± 1 V vernier control. Makes hard-to-get driving functions readily available.

The 3300A/3304A combines to give swept and CW sine (<1% distortion), square (<250 ns rise time),

triangular (<1% linearity) waveforms, and sawtooth waveforms (with <5% flyback time).

Two fully-floating non-interacting outputs with separate amplitude controls provide up to 35 V p-p.

Price: hp 3300A Function Generator, \$625.00; hp 3304A Sweep/Offset Plug-in, \$250.00. For full specifications, contact your nearest hp field engineer. Or, write to Hewlett-Packard, Palo Alto, California 94304. Europe: 54 Route des Acacias, Geneva.

097/15

HEWLETT  PACKARD

News Features

Probing the News

- 123 **Computers:** Federal libraries cast a long shadow
- 129 **Integrated electronics:** Semiconductor firms' captive lines capture defense contractors' fancy
- 135 **Manpower:** Recruiters flock to Negro campuses

Electronics Review

- 51 **Advanced technology:** Putting GaAs on sapphire
- 52 **Companies:** Fairchild shakeup
- 54 **Consumer electronics:** Pushing tubes for color tv; while others go solid state; Broader use of IC's
- 56 **Manufacturing:** R-f removes photoresist
- 58 **Commercial electronics:** IBM collects the fare
- 60 **Military electronics:** Plastic-packaged circuits
- 60 **Government:** For less competition; It pays to shop around
- 62 **Management:** Belt-tightening at Sperry Gyroscope
- 64 **Communications:** Role of the military satellites
- 66 **For the Record**

Electronics Abroad

- 221 **Japan:** IC replaces 35-mm camera meter
- 221 **Great Britain:** Scanning electron microscope checks IC's; Computer quizzes pupils
- 222 **The Netherlands:** Philips' computers rival IBM 360's
- 222 **Canada:** Low-cost gear guides vessels
- 223 **West Germany:** Siemens moves up on IBM
- 224 **France:** CSF trims down
- 224 **Around the world**

New Products

- 147 **TTL makers expand product lines**
- 159 **Components review**
 - SCR device replaces thyatron
 - IC holds voltage within .005%
- 165 **Instruments review**
 - The averager uses analog approach
 - Altimeter is all-electric
- 173 **Subassemblies Review**
 - Magnetic-tape reader-writer costs \$1,200
 - Memory stack stores 64,000 bits
 - H-P sells counter parts
- 185 **Semiconductors review**
 - Comparator's fanout is 10
 - IC triggers triacs, SCR's
- 191 **Microwave review**
 - Klystron is tuned in seconds
- 195 **Consumer electronics review**
 - Low-cost color tv camera has broadcast quality

Technical Articles

I. Design

- Design theory** 80 **Taking noise out of weak signals**
Synchronous method of cleaning up microvolt or nanovolt transmissions with a lock-in voltmeter is free of zero-drift and zero error problems
Richard Brower, Brower Laboratories Inc.

- Circuit design** 90 **Designer's casebook**
 - Voltage comparator is made with op amps and logic gates
 - Diodes in a multivibrator lessen frequency variations
 - Transistor and zener protect series regulator

- Solid state** 96 **Fabrication advances boost potential of avalanche diodes**
Improved methods of heat-sinking and new techniques for creating abrupt junctions make the devices strong contenders for microwave power sources
Harry L. Stover, Texas Instruments

II. Application

- Advanced technology** 104 **Storing light and current in crystals**
Ability to absorb energy and release it when tapped makes some lithium- and sodium-doped semiconductors potentially useful as infrared detectors, optical memories, and other optoelectronic devices
Cole W. Litton and Yoon Soo Park
Wright-Patterson Air Force Base

Departments

- 4 Readers Comment
- 8 Who's who in this issue
- 23 Meetings
- 31 Editorial Comment
- 33 Electronics Newsletter
- 69 Washington Newsletter
- 200 New Books
- 203 Technical Abstracts
- 206 New literature
- 211 Newsletter from Abroad

Electronics

Editor-in-Chief: Donald Christiansen

Associate managing editors

Technical: Stephen E. Scrupski
News: Robert Henkel
Copy: Sally Powell

Senior associate editors

Joseph Mittleman, Harry R. Karp

Department editors

Avionics & Space: Alfred Rosenblatt
Computers: Wallace B. Riley
Communications: William Buccu
Components: George Watson
Consumer electronics: John D. Drummond
Design theory: Joseph Mittleman
Industrial electronics: Harry R. Karp
Military electronics: Richard Gundlach

Domestic bureaus

Boston: James Brinton, manager
Chicago: Frederick Corey, manager
Los Angeles: Lawrence Curran, manager; Burton Bell
New York: Howard Wolff, manager
San Francisco: Walter Barney, manager; Peter Vogel
Washington: Robert Skole, manager; Paul Dickson, William F. Arnold

Foreign bureaus

Bonn: John Gosch
London: Michael Payne
Tokyo: Charles Cohen

Copy editors

James Chang, Larry Miller

Graphic design

Art director: Saul Sussman
Assistant art directors: Ann Mella, Valerie Betz, Susan Hurlburt
Production editor: Arthur C. Miller

Editorial research: Kay Fontana

Editorial secretaries: Lorraine Longo, Claire Benell, Lynn Emery,
Patricia Gardner, Barbara Razulis, Frances Vacca

McGraw-Hill News Service

Director: Arthur L. Moore; Atlanta: Fran Ridgway; Chicago: Robert E. Lee
Cleveland: Arthur Zimmerman; Dallas: Marvin Reid;
Detroit: James Wargo; Los Angeles: Michael Murphy
Pittsburgh: Louis Gomolak
San Francisco: Margaret Drossel
Seattle: Ray Bloomberg; Washington: Charles Gardner, Daniel B. Moskowitz,
Herbert W. Cheshire, Seth Payne, Warren Burkett, William Small, William D. Hickman

McGraw-Hill World News Service

Bonn: Robert Dorang; Brussels: George Williamson; Hong Kong: Wes Perry;
London: John Shinn; Mexico City: Gerald Parkinson; Milan: Ronald Taggiasco, Jack Star;
Moscow: Howard Rausch; Paris: Robert E. Farrell, Peter Kilborn;
Rio de Janeiro: Leslie Warren; Tokyo: Marvin Petal

Reprints: Susan Nugent

Circulation: Isaaca Siegel

Publisher: Gordon Jones

Electronics | July 8, 1968, Vol. 41, No. 14

Published every other Monday by McGraw-Hill, Inc. Founder: James H. McGraw 1860-1948.

Publication office: 12821 W. Bluemound Rd., Brookfield, Wis. 53005. Second class postage paid at Brookfield, Wis. 53005.

Executive, editorial, circulation and advertising addresses: McGraw-Hill Building, 330 W. 42nd Street New York, N. Y. 10036. Telephone (212) 971-3333. Teletype TWX N.Y. 710-581-4235. Cable address: MCGRAWHILL N.Y.

Subscriptions solicited only from those professionally engaged in electronics technology. Subscription rates: qualified subscribers in the United States and possessions and Canada, \$6.00 one year, \$12.00 two years, \$16.00 three years; all other countries \$25.00 one year. Non-qualified subscribers in the U.S. and possessions and Canada, \$25.00 one year; all other countries \$50.00. Air freight service to Japan \$50.00 one year. Single copies: United States and possessions and Canada, \$1.00; all other countries, \$1.75.

Officers of McGraw-Hill Publications: Joseph H. Allen, President; Bayard E. Sawyer, Executive Vice President; J. Elton Tuohig, Senior Vice President-Operations; Vice Presidents: John R. Callahan, Editorial; John M. Holden, Marketing; Paul F. Cowie, Circulation; Jerome D. Luntz, Planning & Development; Robert M. Wilhelmy, Controller.

Officers of the Corporation: Shelton Fisher, President and Chief Executive Officer; John L. McGraw, Chairman; Daniel F. Crowley, Donald C. McGraw, Jr., R.E. Slaughter, Senior Vice Presidents; John J. Cooke, Vice President & Secretary; Gordon W. McKinley, Vice President & Treasurer.

Title © registered in U.S. Patent Office; © Copyright 1968 by McGraw-Hill, Inc. All rights reserved. The contents of this publication may not be reproduced either in whole or in part without the consent of copyright owner.

Subscribers: The publisher, upon written request to our New York office from any subscriber, agrees to refund that part of the subscription price applying to copies not yet mailed. Please send change of address notices or complaints to Fulfillment Manager; subscription orders to Circulation Manager. Electronics at address below. Change of address notices should provide old as well as new address, including postal zip code number. If possible, attach address label from recent issue. Allow one month for change to become effective.

Postmaster: Please send form 3579 to Fulfillment Manager, Electronics, P.O. Box 430, Hightstown, New Jersey 08520

Readers Comment

Reverberations

To the Editor:

In my 40 years of work in the scientific field there has never been such a vitriolic denunciation of our work as in the article "Signal gains for electronic music," [April 29, p. 95].

I talked to Professor Milton Babbitt of Princeton University with regard to the paragraph in the article that concerns the RCA Electronic Music Synthesizer. He was very much distressed. Professor Babbitt has given many public concerts of his work produced on the RCA synthesizer. I know of at least two instances where he received very fine reviews in the New York Times. In addition, Professor Babbitt was honored with the New York Music Critics Circle Citation in 1964. Others have also received acclaim for their work on this instrument.

On May 14, Professor Vladimir Ussachevsky, chairman of the committee on direction of the Columbia Princeton Electronic Music Center, wrote me: "Your RCA synthesizer remains our constantly used tool and center of attraction at the Electronic Music Center. We have spent hundreds of hours demonstrating it to students from all over the United States, as well as countless persons from abroad, and I am sure that our visitors have carried away the correct impression of the RCA synthesizer." In view of this I am at a loss to know why you call this development a white elephant.

It was around 1955, during the period that Professors Babbitt and Ussachevsky were producing electronic music, that RCA invited them to work on the RCA synthesizer. They were so intrigued that the Columbia Princeton Electronic Music Center was started in New York City, and the synthesizer moved there.

As for the statement in the article that the synthesizer is on permanent loan, that too is incorrect. The lease is on a yearly renewable basis.

Since RCA is engaged in the reproduction of sound, we carry out

Here's a new digital IC from Sprague. The 54/74107A.

It's a single-chip replacement for the 5473/7473 dual JK m-s flip-flop.

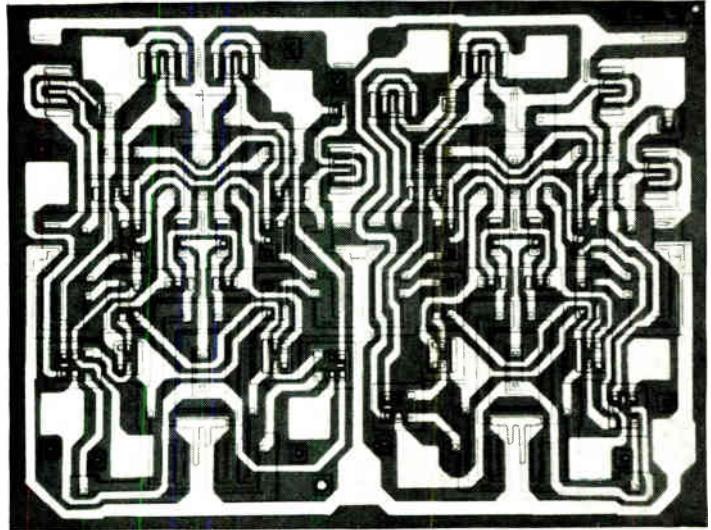

In DIP it has pin 7 GND, just like the rest of the Series 54/74 family.

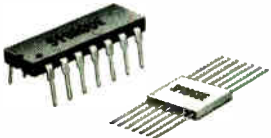

For existing designs, it's also offered in the "old" pinning in either DIP or flat pack.

Choose 0 to +70 or -55 to +125 C temperature range. Choose "old" or new compatible pinning. Choose Sprague for all Series 54/74.

SPECIFICATIONS Dual JK m-s Flip-Flop

	DIP PIN 7 GND	DIP PIN 11 GND	TO-88 PIN 11 GND
0 to +70 C	USN-74107A	USN-7473A	USN-7473J
-55 to +125 C	USS-54107A	USS-5473A	USS-5473J
Clock freq.	15 MHz	15 MHz	15 MHz
P _{diss}	50 mW/ff	50 mW/ff	50 mW/ff
Fan Out	10	10	10

To request samples, call your Sprague representative. For further information, write to Technical Literature Service, 35 Marshall St., North Adams, Mass. 01247.



SPRAGUE WORCESTER . . . the world's finest microcircuit facility.

Introducing the Heinemann JA/Q™ electronics protector:

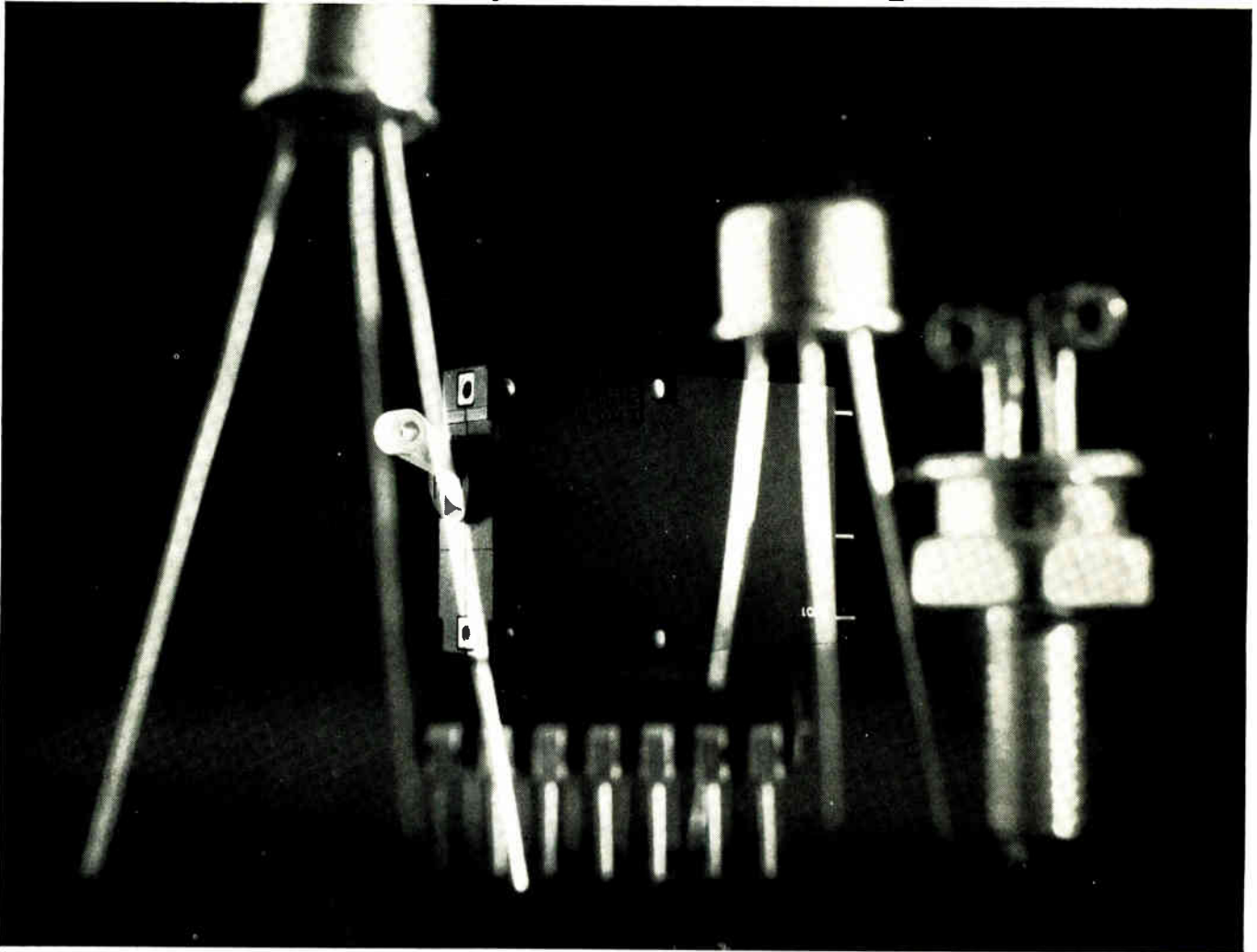

Nanosecond transient/overvoltage response
Millisecond overcurrent trip time

Delicate semiconductors are vulnerable to a trio of electrical hazards: transients, overvoltages, and overcurrents. Only a device which responds to all three can offer adequate protection to solid-state equipment.

Heinemann now offers you such protection, in a single package: the JA/Q electronics protector.

With a JA/Q protector in your equipment, a dangerous transient doesn't stand a chance. The JA/Q will sense it instantly, close an internal solid-state switch, and shunt it to ground. Line voltage passes back through the nominal supply value typically *within 500 nanoseconds*. With the switch closed, the protector trips, removing the equipment from the line in as little as 5 milliseconds.

Overvoltages are handled in the same manner. In fact, the JA/Q is insensitive to rise times: any voltage over the firing point of the protector will trigger it.

For overcurrents, the JA/Q provides protection comparable to a non-time-delay magnetic circuit breaker.

It is guaranteed to trip at 125% of rating. At 200% of rating, it will trip within 20 milliseconds; above 300%, trip time drops to 5 milliseconds. For delayed protection of blowers, starters, and other associated equipment, JA circuit breaker poles with time delays and special function internal circuits can be added to the standard fast-response JA/Q pole.

Any solid-state equipment can benefit from the addition of JA/Q protection. Designers presently using Series JA circuit breakers can now give their equipment triple protection by switching to JA/Q's. No changes in mounting, and only one additional lead—a reference—are required.

To learn more about the JA/Q electronics protector, write for Bulletin 3370. Heinemann Electric Company, 2600 Brunswick Pike, Trenton, N.J. 08602.

4094



HEINEMANN

both pure and applied research in the field of sound reproduction. The reason we developed the synthesizer was to learn more about the sound that we reproduced.

After we developed the synthesizer, Mr. Belar and I decided to test the fidelity of performance of the instrument. To do this we analyzed excerpts from disk records of two piano selections, namely, "Polonaise" and "Clair de Lune" and a violin selection, "Old Re-frain." The piano selections were played by Iturbi, Rubenstein and Horowitz. The violin selection was played by Kreisler. We synthesized the analysis. We then assembled on tape seven original and seven synthesized selections. We played these for musicians, scientists, and laymen. They could not tell which was the real and synthesized. This demonstration showed that the synthesizer was inherently capable of producing great music.

We demonstrated the RCA synthesizer to numerous scientific societies including the National Academy of Sciences, of which I am a member. We received nothing but compliments on the development. The scientific fraternity has recognized the RCA Electronic Music Synthesizer as an outstanding pioneering development in the field of electronic music.

In the entire article I find that the snide, derogatory and irresponsible remarks, wholly lacking in accuracy and sensationally phrased, are all directed towards the RCA Electronic Music Synthesizer. Nowhere else in the article is there any denunciation—only in the section devoted to RCA. I am at a loss to know why you singled out our development for

this undisciplined attack.

Harry F. Olson

Vice president
RCA Laboratories
Princeton, N.J.

James Seawright, technical advisor to the Columbia Princeton Electronic Music Laboratories, told Electronics that the RCA Electronic Music Synthesizer was originally built as a commercial proposition. Electronics did not intend to indicate that it had not been used successfully to compose contemporary music. When Seawright said the sound was "too tinny," he was referring to a harpsichord selection on the machine.

Color them wrong

To the Editor:

In our article, "Isolation problems get an airing," [April 29, p. 75] the two drawings at the bottom of page 77 are in error.

The drawing on the left, of a chip and wire structure, is completely irrelevant. The drawing on the lower right should look exactly like the photograph at the top of page 77. The one shown in the article is of an earlier mask set that is no longer being used.

Hal Clausen

Roger B. Rusert

Fairchild Semiconductor
Mountain View, Calif.

Readers' letters should be addressed:

To the Editor,
Electronics,
330 West 42nd Street, New York,
N.Y. 10036

WHY SETTLE FOR LESS? GET TOP PERFORMANCE

WITH

DELTA'S FABULOUS MARK[®] TEN

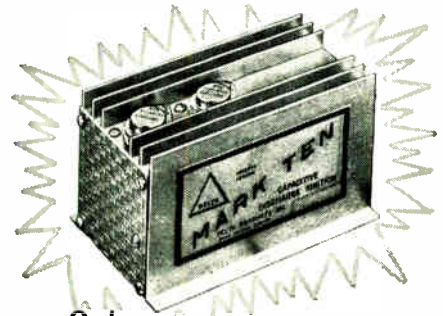

Only

\$44.95 CAPACITIVE
ppd.

Deltakit - Only
\$29.95 ppd.

DISCHARGE

IGNITION SYSTEM

You read about the Mark Ten in the April issue of Popular Mechanics!

Now discover why even Detroit has finally come around. In 4 years of proven performance and reliability, the Mark Ten has set new records of ignition benefits. No wiring. And works on literally any type of gasoline engine. Buy the original, the genuine, the real McCoy—Mark Ten. From Delta. The true electronic solution to a major problem of engine operation.

READY FOR THESE BENEFITS?

- ▲ Dramatic Increase in Performance and in Fast Acceleration
- ▲ Promotes more Complete Combustion
- ▲ Points and Plugs last 3 to 10 Times Longer
- ▲ Up to 20% Mileage Increase (saves gas)

LITERATURE SENT BY RETURN MAIL
BETTER YET — ORDER TODAY!

SUBSCRIPTION SERVICE

Please include an Electronics Magazine address label to insure prompt service whenever you write us about your subscription.

Mail to: Fulfillment Manager
Electronics
P.O. Box 430
Hightstown, N.J. 08520

To subscribe mail this form with your payment and check new subscription renew my present subscription

Subscription rates: qualified subscribers in the U.S.: 1 year \$8; two years, \$12; three years, \$16. Non-qualified: 1 year \$25. Subscription rates for foreign countries available on request.

CHANGE OF ADDRESS

ATTACH
LABEL
HERE

If you are moving, please let us know five weeks before changing your address. Place magazine address label here, print your new address below.

name _____

address _____

city _____

state _____

zip code _____



DP 7-8
DELTA PRODUCTS, INC.

P.O. Box 1147 E • Grand Junction, Colo. 81501

Enclosed is \$ _____. Ship prepaid.

Please send: Ship C.O.D.

Mark Tens (Delta Kit) @ \$29.95

(12 Volt Positive or Negative Ground Unity)

Mark Tens (Assembled) @ \$44.95

6 Volt: Negative Ground only.

12 Volt: Specify Positive Ground

Negative Ground

Car Year _____ Make _____

Name _____

Address _____

City/State _____ Zip _____

Need a custom fork oscillator



(in an 11-gram package)

fast?

For process control? Or for test or ground support equipment? Or for a signaling system?

call Varo.



This lead-mounted, 11-gram package is not only compact ($\frac{7}{8}'' \times \frac{7}{8}'' \times \frac{7}{16}''$), it's a lot more rugged than larger fork oscillators. Frequency range is 2KHz to 40KHz. Performance: .05% from -20 degrees C. to +70 degrees C. If we can't adapt this package to meet your specs, we'll build you one that does.

Varo answers fast.

Because our business is oscillators. Not oscillators and ovens and crystals and etc. But oscillators, period. Tell us what you need. We'll tell you how and when. Like we've done for General Precision, Westinghouse, Sandia, Litton, Raytheon, and others. Try us for speed.

Varo's WESCON address is Booth 445 in Hollywood Park



TIME & FREQUENCY PRODUCTS
402 GUTIERREZ STREET
SANTA BARBARA, CALIF.
TELEPHONE (805) 963-2055
TWO 805-4497200

Who's who in this issue

The problems of separating low-level signals from a noise voltage isn't a new one for Richard Brower. He has been living with it for more than 15 years. He received an MSEE degree from Northeastern University in 1955, and in 1961 founded Brower Laboratories Inc., a company producing instruments for the electro-optical field.

One of the firm's new products is similar to the instrument described in the article on page 80. Richard Brower is a strong proponent of the synchronous method of picking out a low-level signal. He notes, though, that most engineers aren't familiar with the technique, and that those that are often don't know how to use it to the fullest advantage. He has developed many practical guidelines to follow.

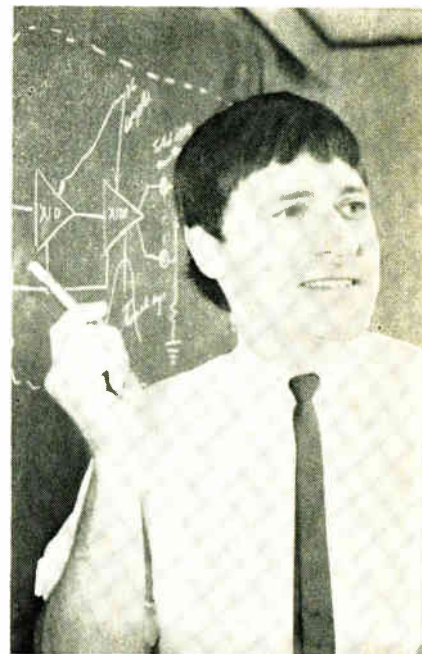

Brower

To our subscribers

If your copy of Electronics arrived late, we apologize. Pressmen at the upstate New York plant that prints Electronics magazine—as well as Business Week, Time, Aviation Week and other major publications—walked out last week and we had to scurry to find another printing plant, with free press time, large enough to handle this 230-page issue on an emergency basis.

The index of activity, which customarily appears in the first issue of each month, was a victim of the strike. It will run in the issue of July 22.

Despite this—and a host of other tribulations—we consider ourselves lucky to have kept reasonably close to our issue date. Many subscribers will get their copies on time thanks to a handful of editors who rushed off to a Wisconsin printing plant to put the book together.

Gordon Jones
Publisher

What started out as a small in-house study of cadmium-sulfide and zinc-sulfide single crystals at the Air Force's aerospace research laboratories has grown into a large program financed partially by outside contracts. Cole W. Litton was in the program when researchers discovered tap effects in these crystals and he has since spent most of

his time studying the electrical and optical properties of CdS. Litton, coauthor of the article on tap crystals on page 104, began working in optics as a research assistant at the University of Tennessee's physical optics laboratory. He took his B.S. and M.S. at the university, and is now on a leave of absence in England working on his Ph.D.

at the University of Reading.

Yoon Soo Park joined the program about the time that work began on ZnO tap crystals. Before coming to the lab he was a physicist at the D.H. Baldwin Co., where he worked on cadmium-selenide film type photoconductors. A native of Korea, he holds a B.S. from Seoul National University, an M.S. from the University of Alberta in Canada, and a Ph.D. from the University of Cincinnati. Park is now investigating the mechanism that triggers tap luminescence.

Park



Litton

Since getting a Ph.D. in plasma physics, Harry L. Stover has been concerned with the interactions between electron microwaves and semiconductors. The author of the piece on avalanche diodes on page 96 was trained in physics, mathematics, and German at Southern Methodist University, where he received his B.A. and B.S. He also holds an M.S. and doctorate from Stanford University.

Stover has been a physicist at the Bell Telephone Laboratories, where his work included the injection locking of such high-frequency devices as tunnel diodes, avalanche diodes and lasers.

Since 1966, he has been section manager of the exploratory microwave device and applications group at Texas Instruments.

Stover

Here's a new direct- reading broad range capacitance meter



MODEL 2W1
\$197.⁰⁰

This new instrument covers the range from 300 pF to 10,000 μ F. An easy-to-read scale on a large 4" meter gives you readings to $\pm 3\%$ accuracy.

Impressed voltage is only 1 volt a-c, thus low voltage electrolytic capacitors may be safely measured.

Solid-state circuitry provides drift-free measurements without warm-up, makes the 2W1 small and lightweight. Only 6" high x 8½" wide x 5" deep, it fits neatly into inspection stations!

Put this versatile capacitance meter to work at incoming inspection, on the production line, in the lab, or out in the field.

For complete technical data, write for Engineering Bulletin 90,020 to the Technical Literature Service, Sprague Electric Co., 35 Marshall Street, North Adams, Mass. 01247.

SPRAGUE[®]
THE MARK OF RELIABILITY

Fairchild has introduced 40 new products in the last 40 weeks.

Our goal is fifty-two new integrated circuits in fifty-two weeks. To obtain the Reader Service number for any product announcement ad, simply add 100 to the new product number. For example, New Product No. 3 is Reader Service No. 103.

<p>9100 HIGH LEVEL HEX CONVERTER</p>	<p>9122 HIGH LEVEL HEX CONVERTER</p>	<p>9085 FOUR-BIT BINARY COUNTER</p>	<p>μA720 HIGH FREQUENCY COMMUNICATIONS SYSTEM</p>	<p>9055 EXPANDABLE HEX INVERTER</p>	<p>9200 DUAL J-K FLIP-FLOP</p>	<p>9201 ONE-OF-TEN DECODER</p>	
<p>3102 NMOS THREE-INPUT GATE</p>	<p>3700 FOUR-CHANNEL MULTIPLEX SWITCH</p>	<p>3303 DUAL 25-BIT DYNAMIC SHIFT REGISTER</p>	<p>8457 8-BIT DUAL TO SEVEN-SEGMENT DECODER</p>	<p>9023 DUAL DIFFERENTIAL LINE RECEIVER</p>	<p>9021 DUAL LINE DRIVER</p>	<p>3300 25-BIT NMOS STATIC SHIFT REGISTER</p>	<p>9100 HIGH LEVEL LOGIC HEX INVERTER</p>
<p>4500 BIPOLAR MICROMATRIX ARRAY</p>	<p>3420 NMOS 64-BIT 4-PHASE SHIFT REGISTER</p>	<p>3705 8-CHANNEL NMOS MULTIPLEX SWITCH</p>	<p>μA722 PROGRAMMABLE I/A - A/D CONVERTED CURRENT SOURCE</p>	<p>4501 DUAL FOUR-BIT COMPARATOR</p>	<p>9024 DUAL 256-BIT READ-ONLY MEMORY</p>	<p>3750 16-BIT NMOS 1.5μ I/A CONVERTER</p>	<p>9224/9225 INTERFACE CIRCUITS</p>
<p>μA727 TEMPERATURE COMPENSATED DIFFERENTIAL PREAMP</p>	<p>9591 RETRIGGERABLE MULTIVIBRATOR</p>	<p>μA701 FREQUENCY COMPENSATED OPERATIONAL AMPLIFIER</p>	<p>3500 8-BIT NMOS 1.5μ PARALLEL ACCUMULATOR</p>	<p>3501 1624-BIT NMOS 1.5μ STATIC READ-ONLY MEMORY</p>	<p>9200 DUAL FOUR-INPUT DUAL IN MULTIPLEXER</p>	<p>3304 NMOS 1.5μ 16-BIT STATIC SHIFT REGISTER</p>	<p>9200 DUAL FOUR-BIT LATCH</p>
<p>3700 3101 NMOS FUNDAMENTAL ELEMENTS</p>	<p>μA737 COLOR TV CURSOR REMODULATOR</p>	<p>3301 NMOS 10-BIT SERIAL PARALLEL PARALLEL SERIAL CONVERTER</p>	<p>4500 1μA MICROMATRIX ARRAY</p>	<p>July 15, 1968</p>	<p>July 22, 1968</p>	<p>July 29, 1968</p>	<p>August 5, 1968</p>
<p>August 12, 1968</p>	<p>August 19, 1968</p>	<p>August 26, 1968</p>	<p>September 2, 1968</p>	<p>September 9, 1968</p>	<p>September 16, 1968</p>	<p>September 23, 1968</p>	<p>September 30, 1968</p>

More about:

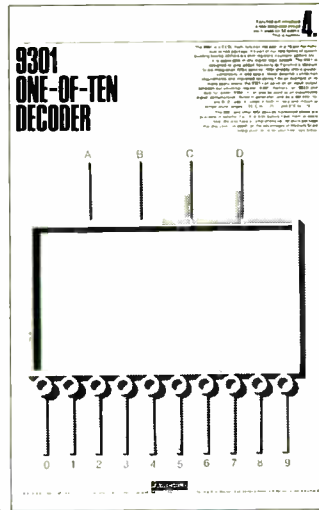
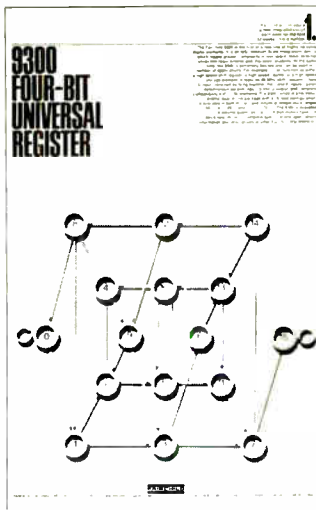

Up/down decoded decade counter.

Combine New Products #1 and 4, and you have the basis of an up/down counter with decoded outputs for process control. If only the decoded outputs are used, you don't need a weighted up/down counter. A shift counter will do the job.

The 9300 universal register can be used to form a decade shift counter counting through a sequence of 10 stable states. A logic "1" or "0" is injected into the first stage of the register at each clock pulse and the previous contents shift one place. After 10 clock pulses, the shift counter has passed through all 10 stable states in a loop. On the next clock pulse, it arrives back at the starting state. A shift register can be made to count in this sequence by decoding the states through which it passes and by using the decoder outputs as a minterm generator to effectively force a logic "1" at the input of the shift register when the state sequence demands. The following block diagram shows a circuit of this type which requires only four devices.

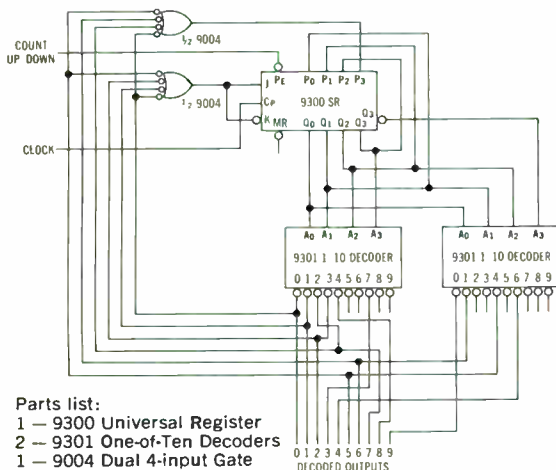

- Parts list:
 1 — 9300 Universal Register
 2 — 9301 One-of-Ten Decoders
 1 — 9004 Dual 4-input Gate

Consider the up count sequence below with the desired input for the next state included:

In states 0000, 1000, 1100 and 0011 a logic "1" must be forced into the first stage of the shift register on the next clock pulse. This may be accomplished by using two 9301 one-of-ten decoders to decode all the sixteen possible minterms from four variables, then sum the appropriate minterms by a 4-input active low input OR

gate and let the OR gate drive the JK inputs connected together on the 9300 shift register. Each 9301 decoder acts as a $\frac{1}{8}$ decoder with the most significant A_3 input acting as an enable input. The first three outputs of the shift register go to the first three inputs of the decoders and the first decoder has Q_3 from the shift register as the A_3 input and the other decoder the Q_2 thereby producing a one-of-sixteen decoder. The outputs of the two decoders are so arranged as to give the decoded outputs in sequence which can then be used to select or drive external circuitry.

COUNT SEQUENCE									
UP					DOWN				
Q_0	Q_1	Q_2	Q_3	INPUT	Q_0	Q_1	Q_2	Q_3	INPUT
0	0	0	0	1	0	0	0	1	0
1	0	0	0	1	0	0	1	0	0
1	1	0	0	1	0	1	0	0	1
1	1	1	0	0	1	0	0	1	1
0	1	1	1	0	0	0	1	1	1
0	0	1	1	1	1	0	1	1	1
1	0	0	1	0	0	1	1	0	0
0	1	0	0	0	1	1	0	0	0
0	0	1	0	0	1	0	0	0	0
0	0	0	1	0	1	0	0	0	1

The synchronous parallel enable facility can be employed to make the shift register effectively shift to the left rather than the right by connecting the three most significant shift register outputs to the corresponding lower stage parallel inputs and operating the 9300 in the parallel enable mode. The same shift count sequence can now be used. Appropriate minterms are summed by an additional active low input OR gate which drives the shift left counter, making it pass through the same 10 stable states as before, but in the opposite direction. By this means, the shift counter performs as an up/down decoded decade counter with the parallel enable/shift input as a count up/count down control. Since only the desired minterms are summed and logic "0s" are inserted into the first stage of the register rather than at specific states, no lock-up sequence can occur.

To obtain specifications and other applications information, simply circle Reader Service numbers 101 and 104. If you have an immediate requirement, call your local Fairchild distributor now.

FAIRCHILD
SEMICONDUCTOR

Fairchild Semiconductor A Division of Fairchild Camera and Instrument Corporation 313 Fairchild Drive, Mountain View, California 94040 (415) 962-5011 TWX: 910-379-6435

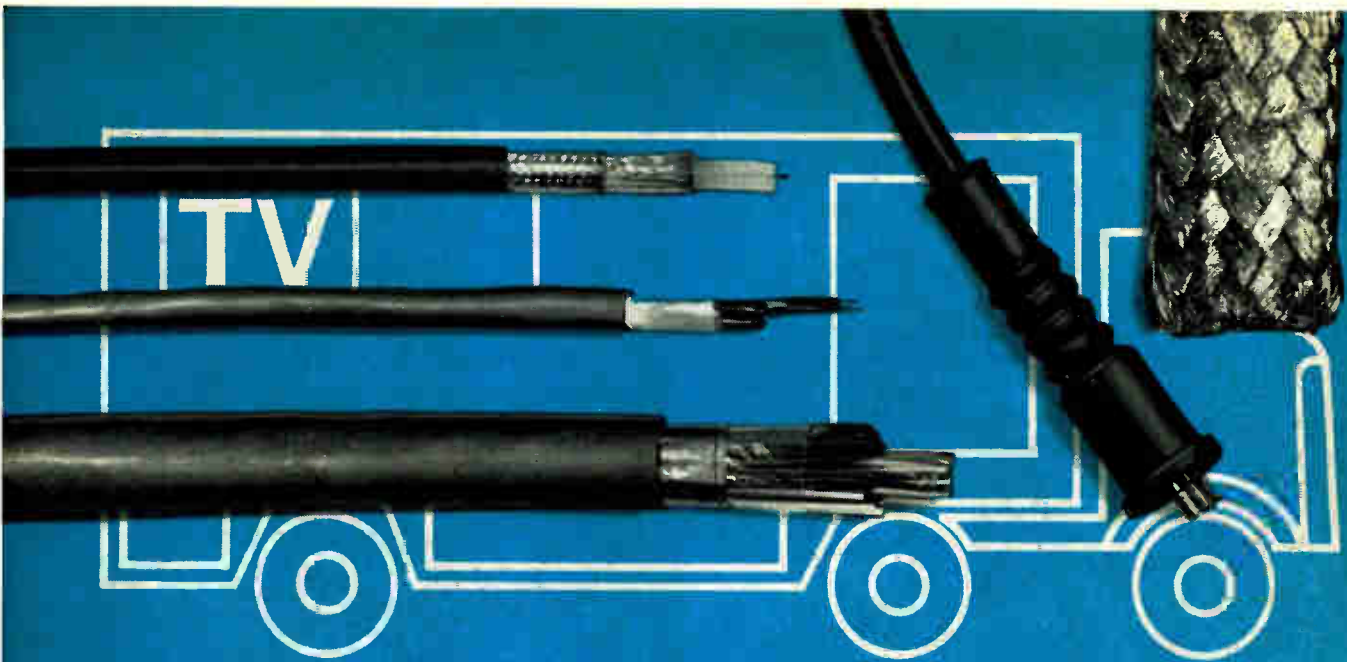

talk about systems...

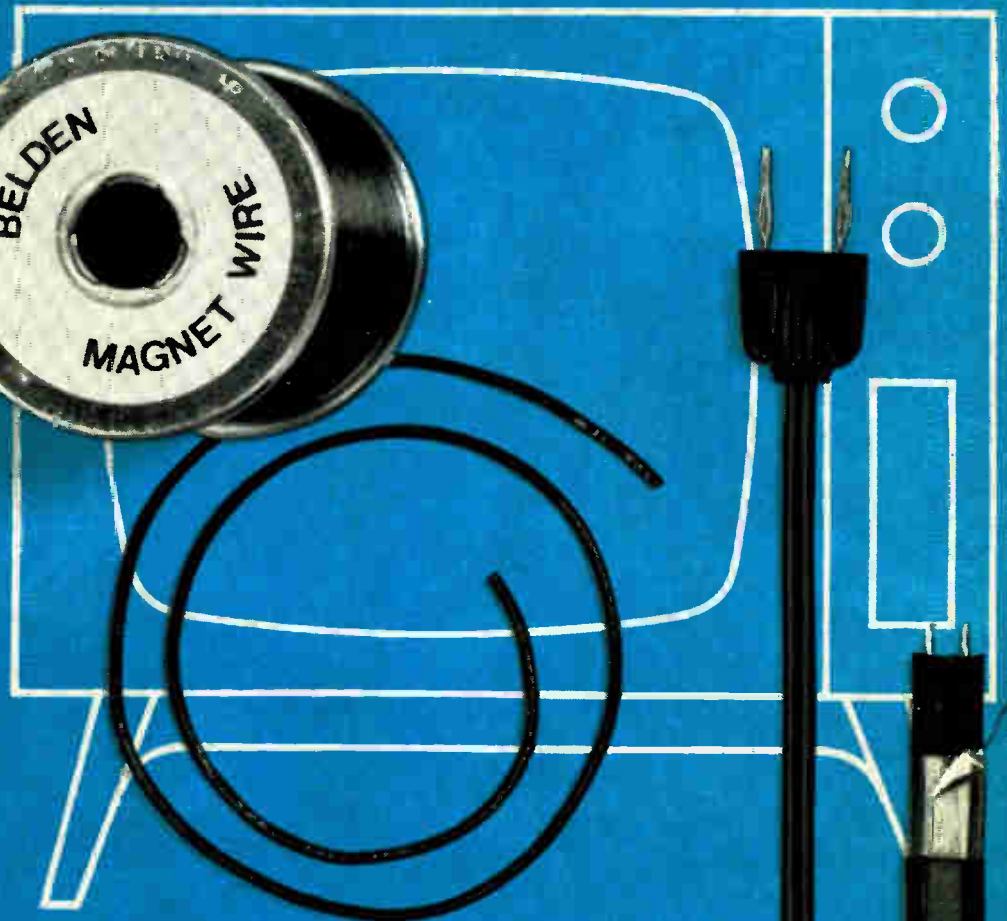

new ideas for moving electrical energy

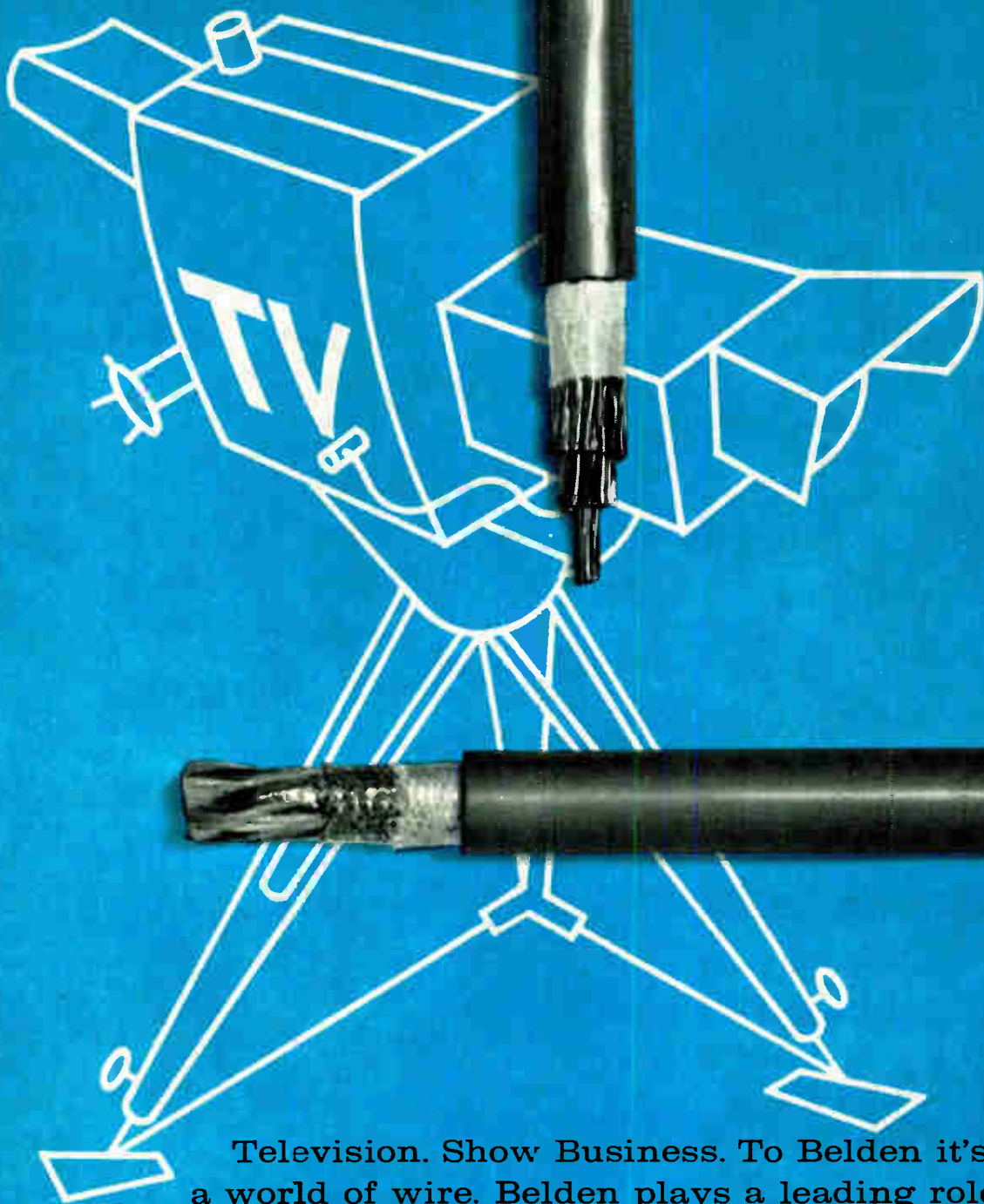

Television. Show Business. To Belden it's all a world of wire. Belden plays a leading role in many complex systems of sight and sound communication. By delving into design, processing, packaging and a host of factors, Belden's team of wire specialists have helped many people wring out hidden costs. Success takes a supplier that is really perceptive – one who makes all kinds of wire for all kinds of systems. Want to join us in wringing out values and costs? Just call us in...Belden Corporation
P.O. Box 5070-A, Chicago, Illinois 60680.



Who's who in Electronics

VSWR Measurement

VSWR (Reflection Coefficient) can be measured over bandwidths as wide as 2500:1 with Texscan Reflection Coefficient Bridge Kits. Speed of measurement and accuracy make these instruments important tools for both the production line and the laboratory.

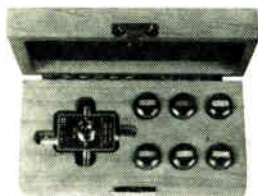
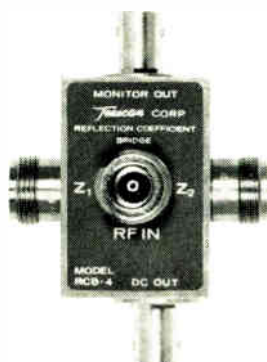

Bridge Kits

contain: 1 Reflection Coefficient Bridge, 2 Standard Loads and 3 Standard Mismatches

KRCB-3 . . .
. . .5 MHz to 1 GHz

KRCB-4 . . .
. . .5 MHz to 2.5 GHz



TEXSCAN CORPORATION

2446 N. Shadeland Avenue
Indianapolis, Indiana 46219
Telephone (317) 357-8781
TWX: 810 - 341 - 3184

It's no accident that the Amperex Electronic Corp. built its new electro-optical facility next door to its semiconductor plant in Slatersville, R.I. Norman Neumann, newly appointed vice president and general manager of the Semiconductor and Microcircuit division, says he will be working very closely with the Electro-Optical division. Kenneth Spitzer, the new general manager of that division, says they'll work toward using photodiodes to replace the photoconductive layer in a television pickup tube. Spitzer, 38 years

old, who helped organize the Electro-Optical division in 1959, says 500,000 to 1,000,000 discrete silicon diodes would be needed for each tube.

The Electro-Optical division, he says, also plans to diversify its



Spitzer

product line from pickup devices and X-ray image intensifiers into low-light-level amplifiers, infrared detectors, channel multipliers, and various hybrids of the Plumbicon tube.

The division expects to double its work force to 300 by 1970. A key aim of these expansion plans is the application of solid state devices to electro-optical technology, and this is where Neumann and the Semiconductor division come in. Neumann, 42, a former vice president and general manager of the General Instrument Corp.'s Semiconductor and Components division, says one of his reasons for coming to Amperex was the chance to apply his knowledge of solid state technology to electro-optics.

Neumann says his division will enter new areas of the semiconductor business. He won't say which, but strongly hints at the possibility of metal oxide semiconductor development.



Neumann

For more than a decade the Phillips Petroleum Corp. has been developing its own process control techniques and building its own



New Machlett tetrode... for single tube design at high power levels

Vapor-cooled ML-8785 (or ML-8786, water-cooled) is particularly suitable for these applications:

High Power Communications

Class C Telegraphy... to 350 kW

Linear RF Power Amplification

Class AB—Suppressed Carrier Service to 260 kW PEP

Pulse Modulation or Amplification

40 kv	DC Plate Voltage
50 kv	Peak Plate Voltage
500 a	Pulse Cathode Current
1000 μ s	Pulse Duration
.01	Duty
Pulse Power to 15 Mw	

Write today for details on these versatile "single-tube-design" tetrodes. The Machlett Laboratories, Inc., 1063 Hope Street, Stamford, Conn. 06907.



THE MACHLETT LABORATORIES, INC.

A SUBSIDIARY OF RAYTHEON COMPANY

The company that developed the industry's first precision R & D lab etcher



now gives you a choice.

Until recently, you couldn't buy a precision etcher designed specially for experimental and laboratory etching of small PC boards, ceramic chips, and thick film masks.

Then Western Technology introduced the Dynamil VRP 50. Compact, portable and only \$995, yet containing all the design features of our well-known Dynamil VRP production series. Rugged all-PVC and Titanium construction — automatic resetting timer — 500-watt Titanium heater — dual spray manifolds — and our exclusive VRP etching mechanism that ensures consistent 1 mil line/1 mil space etching.

Now we've added the Dynamil VRP 70. Same size as the 50, but fully instrumented for closely controlled etching. Included are a Baumé monitor and hydrometer for constant Baumé readings — solid-state proportional temperature controller and Titanium cooling coil for regulating etchant temperature to ± 1 F — and a control valve for variable nozzle pressure. Price — \$2,995.

When it comes to lab etchers — or large capacity precision production models — Western Technology's Dynamil VRP Series is the logical place to turn.

For all the facts, write for a brochure.



WESTERN TECHNOLOGY INC.
220 WEST CENTRAL AVENUE SANTA ANA, CALIF. 92707
(714) 546-6186 (213) 625-1065

Who's who in Electronics

electronic instrumentation. Now, Phillips has formed a subsidiary, Applied Automation Inc., to sell its process control-systems—even to its competitors. The man who helped convince Phillips to take this plunge is Thomas C. Wherry, who formerly directed the parent company's development efforts in process and computer control. Not unexpectedly, he has been named manager of research and development for the subsidiary, which is in Bartlesville, Okla.

Wherry believes that Applied Automation's strength lies in systems development and applications — talent which large and small process control firms find scarce. The company's over-all strategy, he says, is to study a customer's control problems and then specify, build, and install the appropriate system.

Based on his experience with several computer-control projects for Phillips, Wherry anticipates some major changes from current practices in the control field. For example, he suggests there may be more emphasis on hardware and less on software.

On the chip. "Present-day computers are too hard to program, so we may be taking a different approach by designing integrated circuits that have the control equations (algorithms) built onto printed-circuit cards. Soon, we may be doing the same thing with large-scale integrated circuits," he explains.

This means that when Applied Automation starts writing systems specifications and builds or buys computers to these specs, many of the functions now done in the main frame may be accomplished in the input-output equipment.

Wherry's not stretching the technology when he talks about such new computer systems. The group he headed at Phillips has already installed one—a direct-digital-control system for Phillips' Sweeny, Texas, refinery. Its output cards, designed and made by Phillips, include digital-to-analog conversion and the control algorithm.



Charlie Straightarrow was dazzled digitally. Don't let it happen to you!

Charlie Straightarrow is a good engineer. He's been at it for about ten years now. Like a lot of us, Charlie's bought his share of scopes, counters, voltmeters and other assorted test and measurement equipment during that time.

And also like a lot of us, Charlie has been impressed with the digital instrumentation he's seen on the market lately. (So are we, especially since we make the only true RMS digital voltmeters. But back to our story.) In fact, for awhile this winter Charlie was dazzled digitally. Everything he bought had to be digital. Recently, Charlie was looking for a digital scope when, quite by accident, he stumbled across our little pamphlet **Differential or digital, the unvarnished truth about precision voltmeters.**

Charlie got perspective after that. Charlie found out that the most accurate digital voltmeter on the market today costs upwards of \$4,000. He also found several Fluke differential voltmeters with twice the accuracy of the best digital and ten times the resolution for far less money. Lowest price units are less than \$1,000. Highest, only \$1,535 and that includes AC capability as well. Or, put another way, Is analog dead?

So as Charlie reasonably decided, the problem of choosing a voltmeter comes down to application. A Fluke differential such as our 895A should be your choice in laboratory applications where the ultimate in precision

measurement without ambiguity is required. Accuracy of the Model 895A is 25 parts per million. The best digital is always limited by its parts per million accuracy and plus or minus 1 digit. Resolution of the Model 895A is 1 ppm compared to 10 ppm for the best digital.

It's in systems applications that the digital voltmeter offers the most promise. If your problem involves making a great number of measurements using relatively untrained personnel and if accuracy demands are modest, then the digital voltmeter is usually the best answer. But if you need accuracies better than even 100 ppm, then the dollar-performance bias is in favor of the differential voltmeter.

If you would like to stop "digital dazzle" too, write for the same pamphlet Charlie read. We'll even send one to digital design engineers. Please address: Frank Peep for your free copy.

(P.S. our readout is digital, too!)

The Fluke Model 895A solid state differential voltmeter is

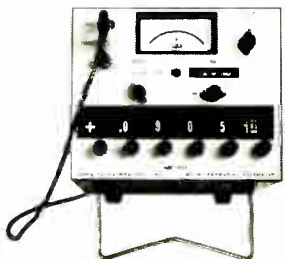

but one of more than 150 precision voltmeters, calibrators, power supplies, and frequency and time instruments. Components for Fluke instruments are tested and checked out in one of the best standards labs anywhere (the only lab more complete is operated by the NBS). Fluke instruments are guaranteed to work in your environment. Or put another way, if the Fluke instrument doesn't work there, you can't live there.



FLUKE

Fluke, Box 7428, Seattle, Washington 98133. Phone: (206) 774-2211. FWX: (910) 449-2850. In Europe, address Fluke International Corporation, P.O. Box 5053 Ledehoestraat 27, Tilburg, Holland. Telex: 844-50237. In U.K., address Fluke International Corporation, P.O. Box 102, Watford Herts, England.

See us at WESCON Booths #2301, 2302, 2303

MAGNETICS

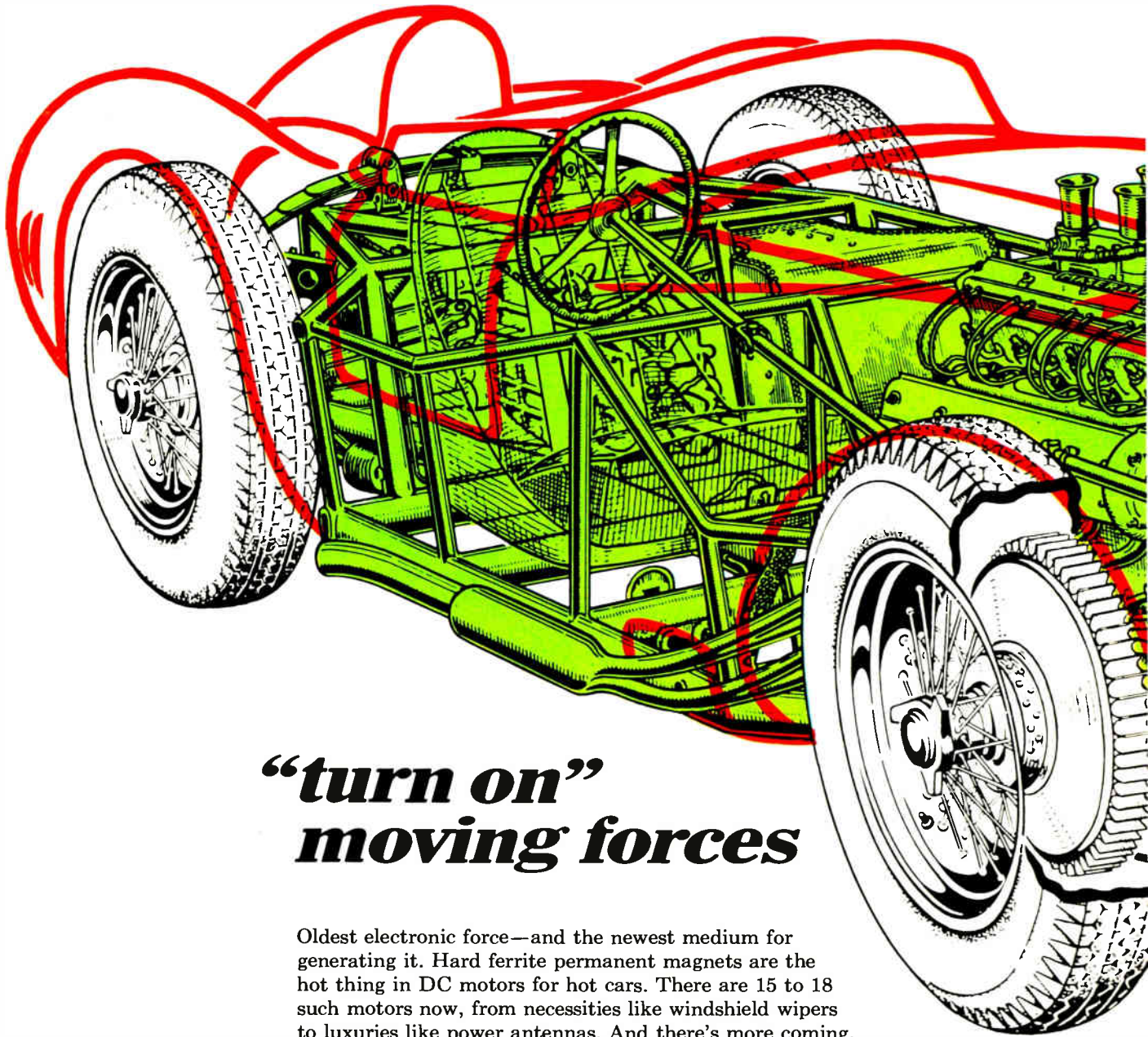

“turn on” moving forces

Oldest electronic force—and the newest medium for generating it. Hard ferrite permanent magnets are the hot thing in DC motors for hot cars. There are 15 to 18 such motors now, from necessities like windshield wipers to luxuries like power antennas. And there's more coming. Forward-looking manufacturers are now experimenting with hard ferrite starters and alternators. And, of course, forward-looking manufacturers look at Arnold for high-quality magnetic materials, design, technology, components. Magnetic cores. Powder cores. Laminations. Permanent magnets. You ask. We'll supply. The best in magnetic materials.

BY ARNOLD

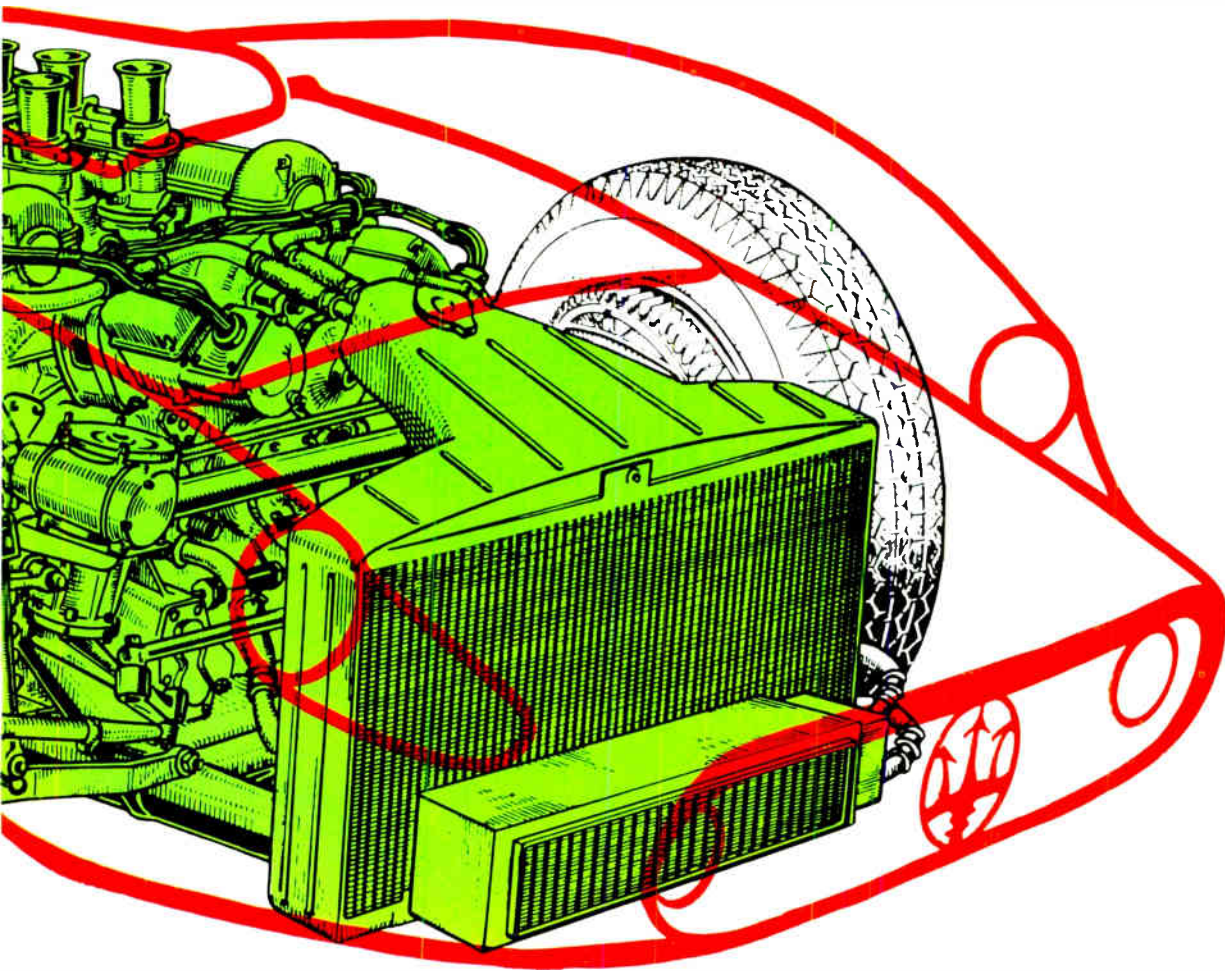

ARNOLD

SPECIALISTS IN MAGNETIC MATERIALS

The Arnold Engineering Company, Main Office: Marengo, Ill.
Branch Offices and Representatives in Principal Cities

In the average family car you'll find hard ferrite permanent magnets in windshield wiper motors • power windows • heater • defroster • rear window defogger • power seats • power antenna • air conditioner. Arnox I magnets collect metal chips in the transmission and differential. An Arnold Alnico magnet for loudspeakers helps the radio sound off.



Write for your free guide to the only complete line of magnetic materials.



PASSIVE & ACTIVE TOTAL

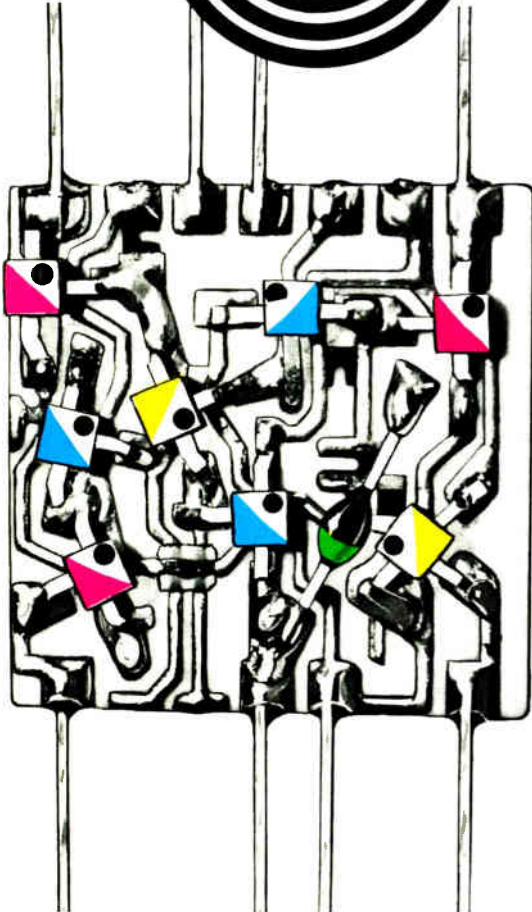

Miniature Discrete Devices – Planar Soldered Construction – Conformal Coat

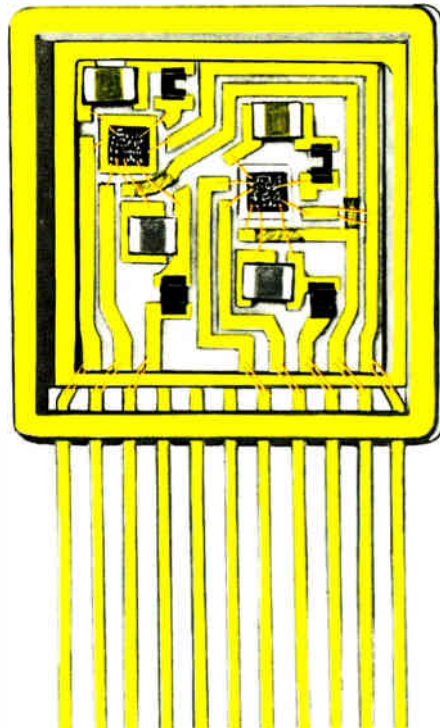

Uncased Monolithic Chips – Thermal Bond Construction – Hermetic Flat Pack

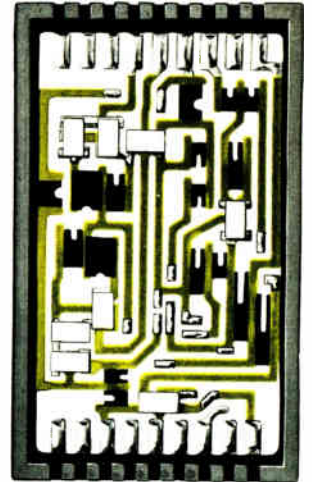

Leadless Inverted Devices – Soldered Construction – Plastic Pack

1 CTS CERMET PROVIDES GREATER STABILITY under all operating conditions, particularly high temperatures. CTS cermet is a patented resistive material available only from CTS.

2 EXCELLENT TC. Exclusive CTS cermet provides excellent temperature coefficient at high sheet resistance (ohms per square).

3 ATTACHMENT TECHNIQUES. Six methods of attaching active devices are available: chip and wire; flip chip; LID attachment; beam lead; welded or soldered planar construction and hole through. These techniques allow unrestricted use of all semiconductor device types.

4 PACKAGING. Packaging includes hermetic seal using T05; T08; and flat packs up to 1½" square. Conformal coat, plastic shell and transfer molding are also available.

5 PASSIVE CIRCUITS. CTS can also provide you with passive modules for applications where active devices are mounted externally or where you may prefer to attach the active devices to the passive module.

6 Manufactured by
CTS MICROELECTRONICS, INC.
BOX 1278, LAFAYETTE, INDIANA 47902

CIRCUITS

CAPABILITY

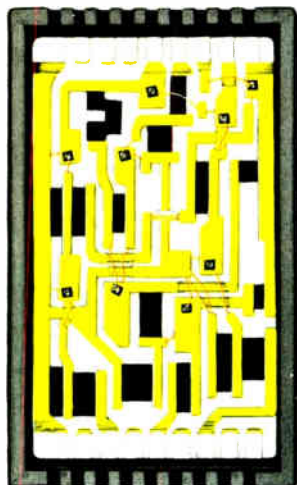

Uncased Chips – Thermal Bond Construction – Plastic Pack

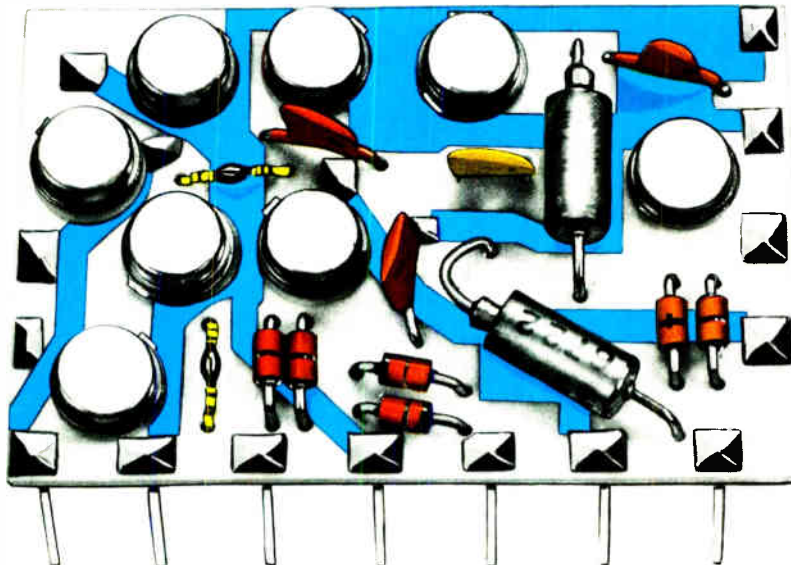

Standard Discrete Devices – Hole Through Soldered Construction – Conformal Coat

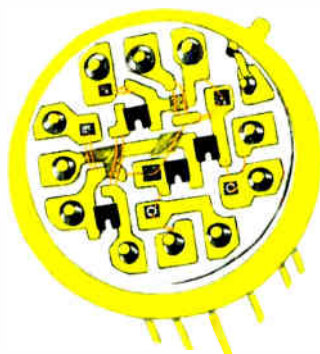

Uncased Chips – Thermal Bond Construction – Hermetic TO8 Pack

Note exceptionally high stability and excellent TC

Chip (die) attach 380°C for 15 min.	0.5% ΔR
Short term temp stability 500°C for 60 min.	1.0% ΔR
Max hot spot temp (without solder)	200°C
Load life 10,000 hrs. @ 125°C	1% ΔR
TC –55°C to 125°C (10 Ω to 1 meg)	± 100 ppm/°C
TC –55°C to 125°C (1 meg to 10 meg)	± 250 ppm/°C
Moisture resistance	0.5% ΔR
Full load temp	125°C
Solder dip @ 250°C for 15 sec.	0.5% ΔR



Founded 1896

CTS
CORPORATION
CIRCUITS TO SPECIFICATIONS

YOU MEAN I SHOULD BUY **GENERAL ELECTRIC**
PANEL METERS AND METER RELAYS
NOT JUST BECAUSE THEY'RE **GENERAL ELECTRIC-**
NOT JUST BECAUSE THEY'RE THE FULLEST LINE IN
THE INDUSTRY, BUT BECAUSE THEY'RE BACKED BY A
SALES AND SERVICE ARMY READY TO HELP ME
AT A MOMENT'S NOTICE?

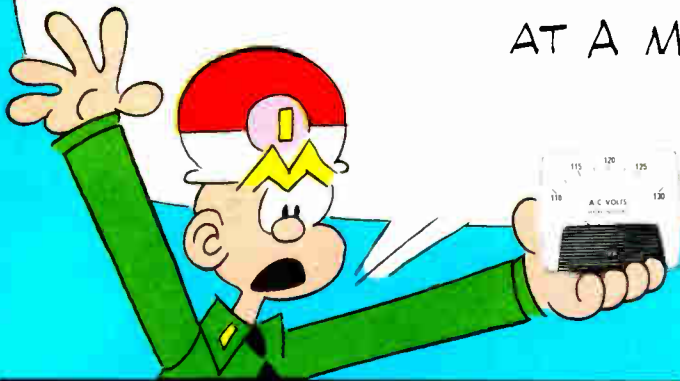

YOU'VE GOT
THE GENERAL IDEA

General Electric's Sales and Service Army—the largest in the industry—offers you the fullest line of quality panel meters. And that same Sales and Service Army is at your command, ready to bring you the finest, most comprehensive back-up available—whenever you need it. Remember, quality instruments and the in-depth ability to back them up are yours every time you specify and buy panel meters from General Electric. Contact your GE Electronic Components Sales Office or your dependable General Electric panel meter distributor.

592-33

GENERAL  **ELECTRIC**

Meetings

Wescon agenda covers a wide range

The 32 technical sessions directly associated with this year's Western Electronic Show and Convention (Wescon) encompass topics ranging from law enforcement to pattern recognition, but those that crop up most often are integrated circuits and communications. Surprisingly, however, large-scale integration isn't included in any of the three sessions devoted to integrated electronics.

Wescon will be held Aug. 20 to 23 in Los Angeles. Two special symposiums are also planned—the usual one on circuit packaging, Aug. 19 and 20, and an applications-oriented program on designing with hybrid circuits, Aug. 21 and 22. The latter will include papers on both thin- and thick-film hybrids and a session on microwave microelectronics.

New directions. Microwave technology will also receive attention at two sessions during the technical program. There will be four papers on microwave IC's and four on microwave solid state receivers. In the former, Arthur Solomon of Sylvania Electric Products Inc. will discuss integrated microwave components and subsystems using beam-lead devices, and a paper by Meyer Gilden of Microwave Associates Inc. will treat avalanche and Gunn oscillators. The other IC ses-

sions will cover new directions in linear devices and include four papers on IC testing as seen by the IC manufacturer, tester manufacturer, industrial user, and military user.

Three sessions are devoted exclusively to communications, and one is the program's only panel discussion. The panel will explore the impact of new technology on data communications. A session entitled "New developments in digital communications" features four papers—two each by representatives of the Hughes Aircraft Co. and of the Autonetics division of the North American Rockwell Corp. A paper by D.M. Motley and G.K. McAuliffe of Autonetics will cover the firm's new adaptive data equalized modem. P.N. Winters of Hughes will explain quadrature signal processing techniques, and is also teamed with J.E. Toffler for a paper on a Hughes data modem. Another Motley and McAuliffe paper is devoted to equalization for data transmissions.

The final session on communications is entitled "The application of state variable and optimal control techniques to communication systems."

For more information write Robert Ashby, Autonetics division, North American Rockwell Corp., 3370 E. Miraloma Ave., Anaheim, Calif. 92803

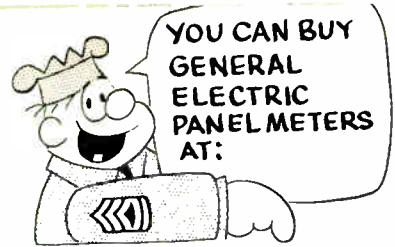

- ALABAMA**
Birmingham
Electronic Supplies, Inc.
Forbes Distributing Co.
Huntsville
Cramer Huntsville
Edgerly Instrument Labs, Inc.
Electro-Tech, Inc.
- ARIZONA**
Phoenix
Hamilton Electro of Arizona
Metercraft, Inc.
- ARKANSAS**
Little Rock
Carlton Sales Co.
- CALIFORNIA**
Culver City
Hamilton Electro Sales
Metemaster, Inc.
Emeryville
General Electric Supply Co.
Glendale
ISD Engineering
Los Angeles
General Electric Supply Co.
Metemaster, Inc.
Mt. View
Hamilton Electro Sales
Palo Alto
Pattullo Electronics
Redwood City
Fortune Electronics
Sacramento
Sacramento Elec. Supply Co.
San Diego
Kewell Electronics
Hamilton Elect. of San Diego
- COLORADO**
Denver
Electronic Parts Co.
L. B. Walker Radio Co.
- CONNECTICUT**
Hamden
Cramer Electronics, Inc.
Hartford
General Electric Supply Co.
- DISTRICT OF COLUMBIA**
Washington
Cramer, Washington
Siberne Radio & Electronics
- FLORIDA**
Ft. Lauderdale
Cramer Florida Electronics
Jacksonville
General Electric Supply Co.
Orlando
Electro-Tech, Inc.
West Palm Beach
Mountain Electronics
- GEORGIA**
Atlanta
Electronic Supply Co.
General Electric Supply Co.
Jackson Electronic Supply Co.
- AUGUSTA**
General Electric Supply Co.
- HAWAII**
Electro-Tech, Inc.
- ILLINOIS**
Chicago
Allied Radio
J. G. Bowman & Co.
Peoria
Hendricks Elec. Co.
Schiller Park
Pace Electronics Supplies
Springfield
Bruce Electronics Inc.
- INDIANA**
Evansville
Ohio Valley Sound, Inc.
Fort Wayne
Fort Wayne Electronic Supply Co.
- INDIANAPOLIS**
General Electric Supply Co.
Graham Electronics
Peerless Elec. Supply Co.
- IOWA**
Cedar Rapids
Hupp Electric Motors, Inc.
Iowa City
Hupp Electric Motors, Inc.
- KANSAS**
Wichita
Radio Supply Co.
- KENTUCKY**
Louisville
P. I. Burks Co.
General Electric Supply Co.
- LOUISIANA**
Baton Rouge
Sterling Electronics
Lafayette
Ralphs of Lafayette
New Orleans
Ago Marine Supply
New Orleans Electric
Supply, Inc.
Sterling Electronics, Inc.
- MARYLAND**
Baltimore
Cramer/Baltimore
Edgerly Instrument Laboratories
- MASSACHUSETTS**
Boston
General Electric Supply Co.
Gerber Radio Supply Co.
Cambridge
E-T Instruments & Controls, Inc.
Lawrence
Alco Electronics
Needham
Instruments, Inc.
Newton
Cramer Electronics, Inc.
Springfield
T. F. Cushing, Inc.
- MICHIGAN**
Detroit
General Electric Supply Co.
Farmdale
Farm Meter, Inc.
Kalamazoo
Warren Radio Co.
Muskegon
Fitzpatrick Electric Supply Co.
Southfield
S. Sterling Co.
- MINNESOTA**
Minneapolis
Electronic Center, Inc.
Lew-Bonn Co.
- MISSISSIPPI**
Jackson
Edgerly Electronic Supply, Inc.
- MISSOURI**
Joplin
Norman Elec. Supply Co., Inc.
Kansas City
General Electric Supply Co.
Radio Labs, Inc.
University City
Olive Industrial Electronics, Inc.
- NEBRASKA**
Lincoln
Scott Electronic Supply Corp.
- OMAHA**
Schneider Elec. & Equipment Co.
- NEW JERSEY**
Roseland
E-T Instruments & Controls, Inc.
Scotch Plains
TRF Electronics
- NEW MEXICO**
Albuquerque
Electronic Parts Co., Inc.
Sterling Electronics, Inc.
- NEW YORK**
Elmhurst
Cramer ESCO
Elmsford
Melville Radio Corp.
Glens Falls
Glens Falls Electric Supply Co.
Great Neck
A&M Instrument
Latham
Latham Electric Supply Corp.
Liverpool
WEI, Inc.
New York City
E-T Instruments & Controls, Inc.
Hudson Electric Sales Co.
Power Instrument Control Sup.
Syracuse
Muller, Evans and Dehl, Inc.
- NORTH CAROLINA**
Charlotte
Dixie Radio Supply Co., Inc.
Greensboro
General Electric Supply Co.
Southeastern Radio Supply
- RALEIGH**
Southeastern Radio Supply Co.
- OHIO**
Akron
Sun Radio
Cincinnati
General Electric Supply Co.
United Radio, Inc.
Cleveland
Christie Laboratories, Inc.
General Electric Supply Co.
Pioneer Standard Electronics, Inc.
Columbus
Buckeye Electric Distr., Inc.
Dayton
Pioneer Standard/Stepco
Toledo
Halleband Electric Supply
Warren Radio Co.
Warren
REM Electronics Supply Co.
- OKLAHOMA**
Oklahoma City
John H. Cole Co.
- PENNSYLVANIA**
Allentown
R. A. Peters, Inc.
Harrisburg
Radio Distributing Co.
McKeesport
Barno Radio Co.
Philadelphia
Almo Industrial Electronics, Inc.
General Electric Supply Co.
Sunshine Scientific Inst.
Pittsburgh
Edgerly Instrument Labs, Inc.
General Electric Supply Co.
York
Rosen Electronics
- RHODE ISLAND**
Providence
W. H. Edwards Co.
- SOUTH CAROLINA**
Charleston
Wholesale Radio Supply
Columbia
Dixie Radio Supply Co., Inc.
Greenville
Dixie Radio Supply Co., Inc.
- TENNESSEE**
Chattanooga
Electro-Motor Sales and
Supplies
Harge Electronic Distributors
Knoxville
Chemcity Electronics
General Electric Supply Co.
Memphis
Elec. & Mech. Comp. Devices
Lavender Radio & TV
W & W Distributing Co.
Nashville
Electra Distributing Co.
- TEXAS**
Arlington
Arco Beta Electronics
Beaumont
Sterling Electronics, Inc.
Corpus Christi
Electronic Equip. & Engrg. Co.
Dallas
Contact Electronics
Graybar Electric Co.
El Paso
McNicol, Inc.
Houston
Busack Electronic Equip. Co.
General Electric Supply Co.
- UTAH**
Salt Lake City
S. R. Ross, Inc.
- VIRGINIA**
Norfolk
Cain Electronics, Inc.
Richmond
Meridian Electronics, Inc.
Richmond
Peoples Radio &
TV Supply Co., Inc.
- WASHINGTON**
Aberdeen
C&G Electronics
Seattle
Hamilton Electro Corp.
Instrument Laboratory, Inc.
Kierulff Electronics
Spokane
Ind. Instrument Supply Co.
- WEST VIRGINIA**
Bluefield
Meyers Electronics, Inc.
Charleston
Chemcity Electronics
Mountain Electronics Co.
Mountain National Corp.
Huntington
Electronic Supply Co.
Mountain Electronics Co.
- WISCONSIN**
Appleton
General Electric Supply Co.
Green Bay
Beemster Electric Co.
West Allis
Marsh Radio Supply Co.

Calendar

Nuclear and Space Radiation Effects, IEEE; Missoula, Mont., July 15-18.

Design Automation Workshop, IEEE; Washington, July 15-18.

Reliability and Maintainability Conference, American Institute of Aeronautics and Astronautics; Jack Tar Hotel, San Francisco, July 15-18.

International Federation for Medical and Biological Engineering Conference, IEEE; Palmer House, Chicago, July 22-25.

Symposium on Electromagnetic Compatibility, IEEE; Benjamin Franklin Hotel, Seattle, July 23-25.

Conference on Pattern Recognition, Institute of Electrical Engineers, National Physical Laboratory; Teddington, Middlesex, England, July 29-31.

Research Conference on Instrumentation Science, Instrument Society of America; Quinnipiac College, Hamden, Conn., July 29-Aug. 2.

Conference on Electron Microprobe Analysis and Meeting of the Electron Probe Analysis Society of America, Pick-Congress Hotel, Chicago, July 31-Aug. 2.

(Continued on p. 24)

99% Fewer Cavities With Cinch-Graphik

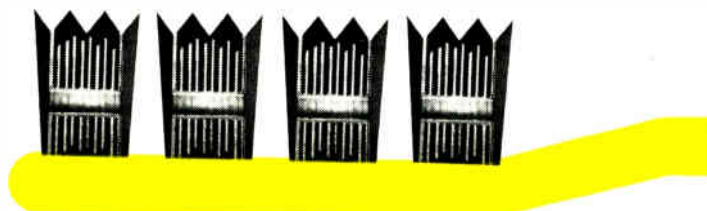

10X MICROPHOTOS OF MULTILAYER THRU-HOLE CROSS-SECTIONS

Cinch-Graphik's advanced multilayer production techniques eliminate voids in thru-hole plating and intra-layer lamination. This is why Cinch-Graphik circuits have greater electrical reliability (complete interface bond between plated thru-hole and individual circuit layers), better final assembly quality (good component contact) and increased physical integrity (no delamination under wave soldering). For a brighter smile, use Cinch-Graphik multilayer circuitry. Write for our illustrated brochure.

CINCH-GRAFIK

D I V I S I O N O F U N I T E D - C A R R



200 South Turnbull Canyon Road, City of Industry (Los Angeles), Calif. 91744 • Phone (213) ED 3-1201. Sales offices in 33 principal cities throughout the United States, Great Britain, Canada, Australia and West Germany.

CONSISTING OF CINCH MANUFACTURING COMPANY, CINCH-GRAFIK, CINCH-MONADNOCK, CINCH-WULINE, UGINITE (ELECTRONICS) AND PLAXIAL CABLE DEPT.

Meetings

(Continued from p. 23)

International Computer Exhibition, International Federation for Information Processing; Edinburgh, Scotland, Aug. 5-10.

Joint Automatic Control Conference, IEEE; University of Colorado, Boulder, Aug. 6-8.

Guidance, Control and Flight Dynamics Conference, American Institute of Aeronautics and Astronautics, Huntington Sheraton Hotel, Pasadena, Calif., Aug. 12-14.

Intersociety Energy Conversion Engineering Conference, IEEE; University of Colorado, Boulder, Aug. 14-16.

International Electronic Circuit Packaging Symposium, IEEE; Statler Hilton Hotel, Los Angeles, Aug. 19-20.

Symposium for Service to the Nation Through Photo-Optical Instrumentation, Society of Photo-Optical Instrumentation Engineers; Washington, Aug. 19-23.

Western Electronic Show and Convention, IEEE; Biltmore Hotel and Sports Arena, Los Angeles, Aug. 20-23.

National Electronics Convention, Institute of Electronic and Radio Engineers and the New Zealand Electronics Institute, Auckland, New Zealand, Aug. 20-23.

Conference on Systems Dynamics and Automatic Control in Basic Industries, Institution of Engineers; Science House, Sydney, Australia, Aug. 26-30.

Astrodynamics Specialist Conference, American Institute of Aeronautics and Astronautics; Jackson Lake Lodge, Jackson, Wyo., Sept. 3-5.

Conference on Solid State Devices, Institute of Physics and the Physical Society, Institution of Electrical Engineers, IEEE; Institution of Electronic and Radio Engineers; University of Manchester, England, Sept. 3-6.

Symposium on Automatic Control in Space, International Federation of Automatic Control; Vienna, Austria, Sept. 4-8.

Electrical Insulation Conference, IEEE; Sheraton Boston Hotel and War Memorial Auditorium, Boston, Sept. 8-12.

Antennas & Propagation Symposium, IEEE; Northeastern University, Boston, Sept. 9-11.

International Broadcasting Convention, IEEE, Institution of Electrical Engineers,
(Continued on p. 26)

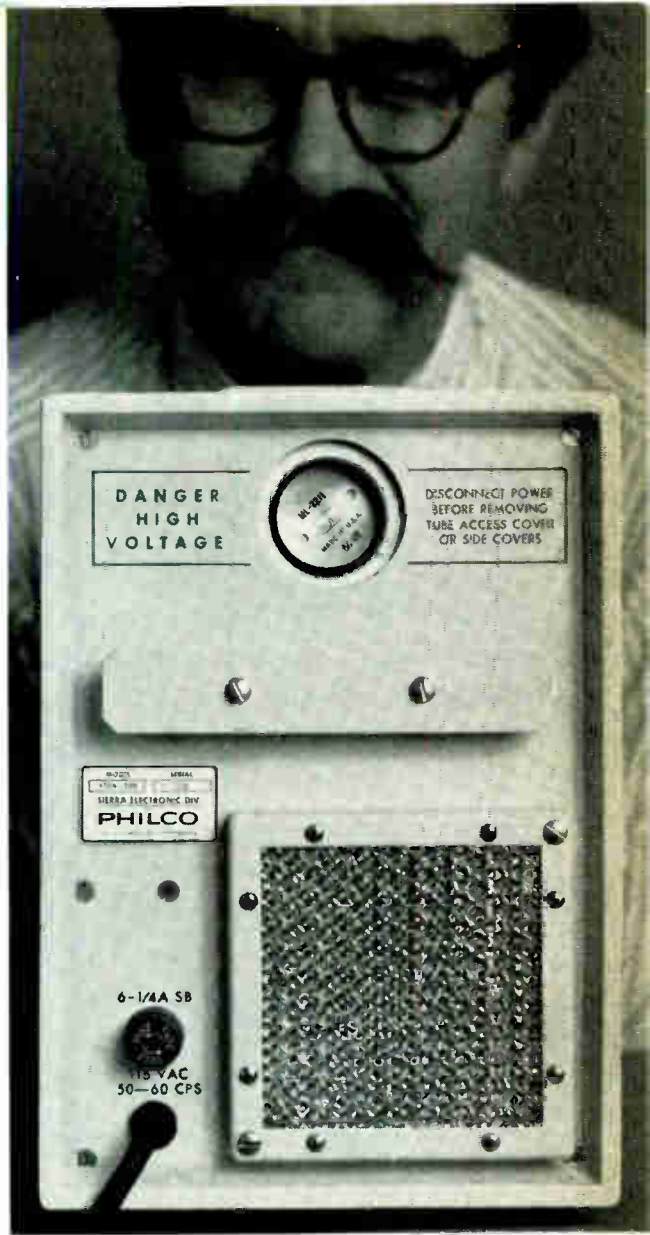

Just by looking at Sierra's new 50-200 MHz High-Power Signal Generator

On the front panel above, for example, a two-range wattmeter that keeps you posted on r-f power output. Right next to it, a meter that monitors grid and cathode current. Above right, see where Sierra has placed the final output tube. You can change it in 30 seconds. In some other high-power signal generators, that tube's out-of-sight and takes hours to change.

Sierra's new Model 470A-200 delivers 50 mw to more than 50 W in a continuously tunable 50-200 MHz range, more than enough power to comply with field-strength requirements of currently effective EMI specifications. It incorporates automatic no-load, underload circuitry. It's capable of CW, square wave (internal or external), or pulse-modulated outputs. A monitor output jack provides power samples 35 dB down from the main output, corresponding to frequency counter input requirements. All-solid-state (save for the final output tube), it measures only 10" x 6 $\frac{3}{4}$ " x 18 $\frac{1}{2}$ ", weighs but 45 lbs.

Model 470A-200's the newest in Sierra's five-instrument line of r-f signal generators, spanning a spectrum of 50 to 2500 MHz. Now, train your eyes on the product brochure, available from Sierra/Philco-Ford, 3885 Bohannon Drive, Menlo Park, California 94025.

...you can see
the advantages!



PHILCO-FORD CORPORATION
Sierra Electronic Operation
Menlo Park, California • 94025

Circle 25 on reader service card

.... How's Your Memory?

If you're not getting what you paid for, give us a call next time you have to order one. Chances are, you won't pay as much and you won't have to make any adjustments to get it to turn on.

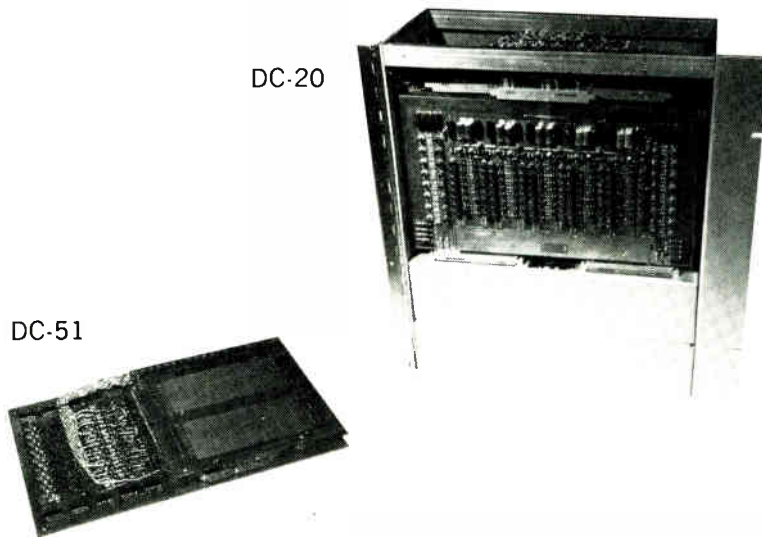

DATA CRAFT MEMORY PRODUCTS

MODEL	SPEED (FULL CYCLE)	MAX. CAPACITY
DC-20	600 NANOSECONDS	8K X 25
DC-30	1 MICROSECOND	1K X 32, 2K X 24, 4K X 18
DC-31	900 NANOSECONDS	512 X 16, 1K X 8
DC-32	1.5 MICROSECONDS	8K X 26
DC-33	1 MICROSECOND	1K X 8
DC-51	4 MICROSECONDS	256 X 18, 512 X 9
DC-53	2 MICROSECONDS	1K X 10

OUR MOST IMPORTANT PRODUCT IS YOUR SATISFACTION.
CALL OR WRITE US TODAY ABOUT YOUR REQUIREMENT.



776 N. E. 40th Court • P. O. Box 23550 • Ft. Lauderdale, Fla. 33307 • Phone (305) 565-9441

Meetings

(Continued from p. 24)

Institution of Electronics & Radio Engineers, Royal Television Society, and the Society of Motion Picture & Television Engineers, London, Sept. 9-13.

Congress of the International Council of the Aeronautical Sciences, American Institute of Aeronautics and Astronautics; Munich, West Germany, Sept. 9-13.

Electronic and Aerospace Systems Conference, IEEE; Sheraton Park Hotel, Washington, Sept. 9-11.

Petroleum and Chemical Industry Technical Conference, IEEE; Marriott Motor Hotel, Dallas, Sept. 9-11.

Electrical and Aerospace Systems Convention, IEEE; Sheraton Park Hotel, Washington, Sept. 9-11.

Short Courses

Modern theory of communications, Ohio University's Department of Electrical Engineering, Columbus, July 15-26; \$275 fee.

Semiconductors in protective relaying circuits, Texas A&M University's Department of Electrical Engineering, College Station, July 22-Aug. 2; \$75 for members of the Electric Power Institute and \$150 for others.

Automation in electronic test equipment, New York University's School of Engineering and Science, N.Y., Aug. 26-30; \$245 fee.

Call for papers

Relay Conference, National Association of Relay Manufacturers and the School of Electrical Engineering; Oklahoma State University, April 22-23, 1969. Aug. 15 is deadline for submission of abstracts to D.D. Lingelbach, Oklahoma State University, Stillwater 74074

Spring Joint Computer Conference, American Federation of Information Processing Society; War Memorial, Boston, May 14-16, 1969. Oct. 7 is deadline for submission of papers and abstracts to T.H. Bonn, Honeywell EDP, 200 Smith St., Waltham, Mass. 02154

Power Industry Computer Application Conference, IEEE; Brown Palace Hotel, Denver, May 18-21, 1969. Nov. 15 is deadline for submission of abstracts to W.D. Trudgen, General Electric Co., 2255 W. Desert Cove Rd., P.O. Box 2918, Phoenix, Ariz. 85002

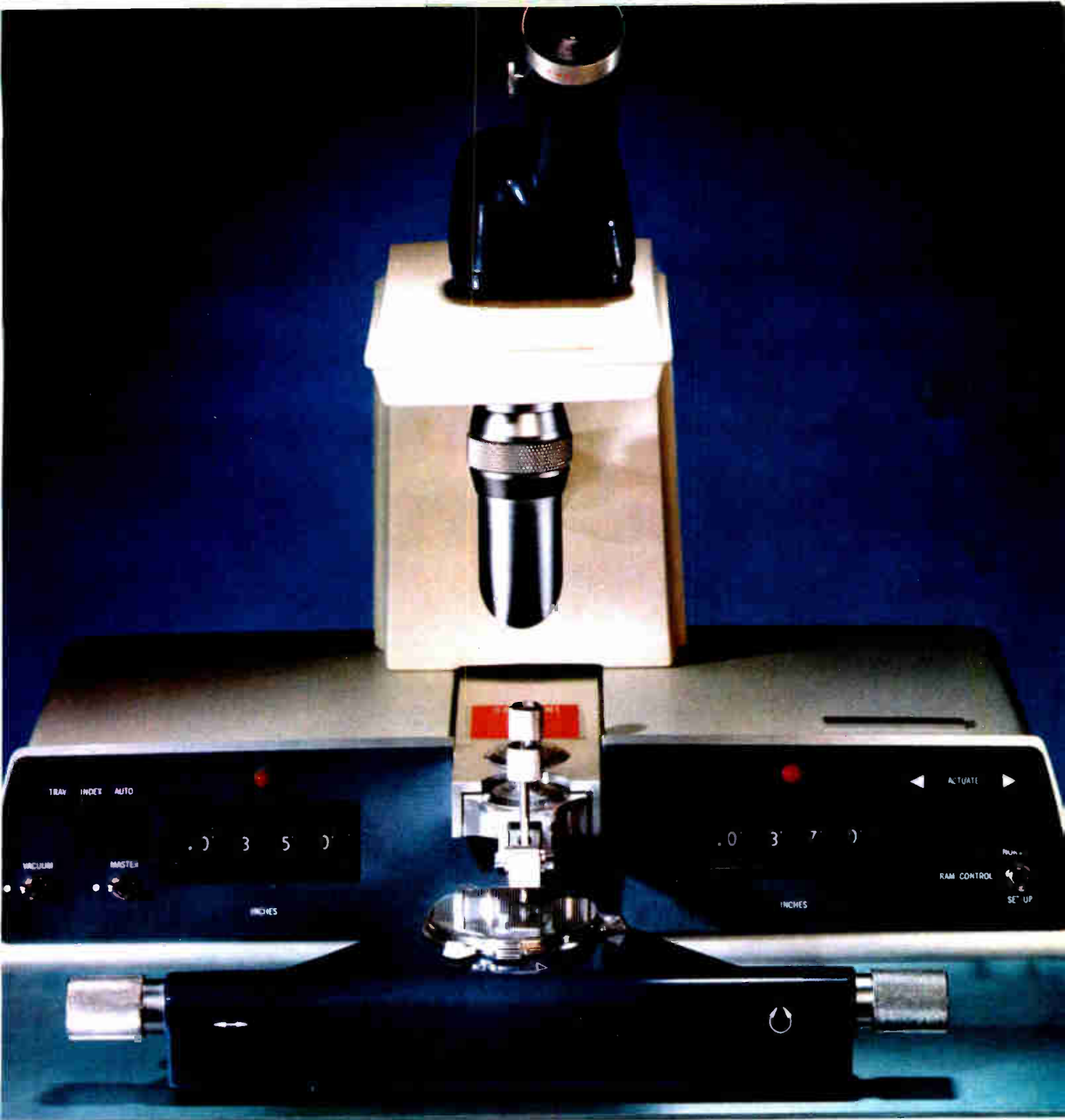

New, more versatile scribing . . . identical operation

Changes have been made in the new Model "C" Tempress Automatic Scribing Machine, but only where they matter . . . to increase operating flexibility and to incorporate improved components where they will contribute to the efficiency, dependability, or longevity of the machine. Follow the same set-up procedures, press "actuate," and you are scribing any rectangular or triangular pattern from .001" to .399", with incremental resolution to .001". How versatile? Choose a model to scribe either 1½" or 2" wafers, decimal or metric indexing, extended range, 50 or 60 cycle operation, without affecting

price. The only option for which you pay extra is a binocular optical system. Third generation of the machine that brought low-cost, automatic scribing to the semiconductor industry, the new Model "C" meets the Tempress Standard of Excellence, your assurance of precision when you purchase any member of the growing family of Tempress miniature assembly tools and production machines.



TEMPRESS

Tempress Research Co., 566 San Xavier Ave., Sunnyvale, Calif. 94086
Circle 27 on reader service card

Design engineers' favorite

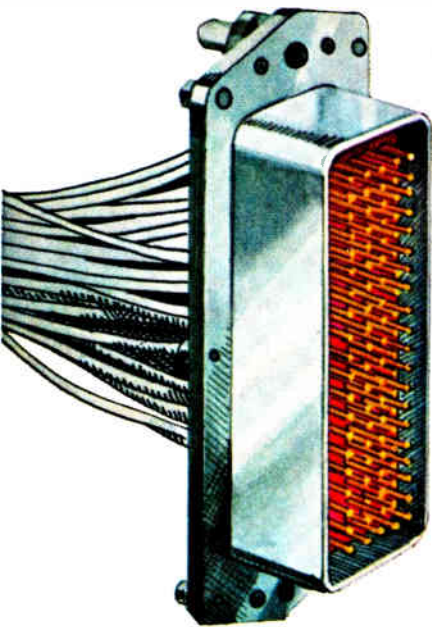

Series A. Fully sealed high reliability connector. Machined pins and sockets, reliable gold over nickel plate. Precision crimped. Available in 50 and 100 contact versions with .100" center spacing.

Series DD. Shell takes two Series D inserts, providing up to 156 contact positions. Cavity identification front and rear. Quick center fastener. Same contacts and operating characteristics as Series D connectors. Optional accessories include straight or 90° shields and cable clamps.

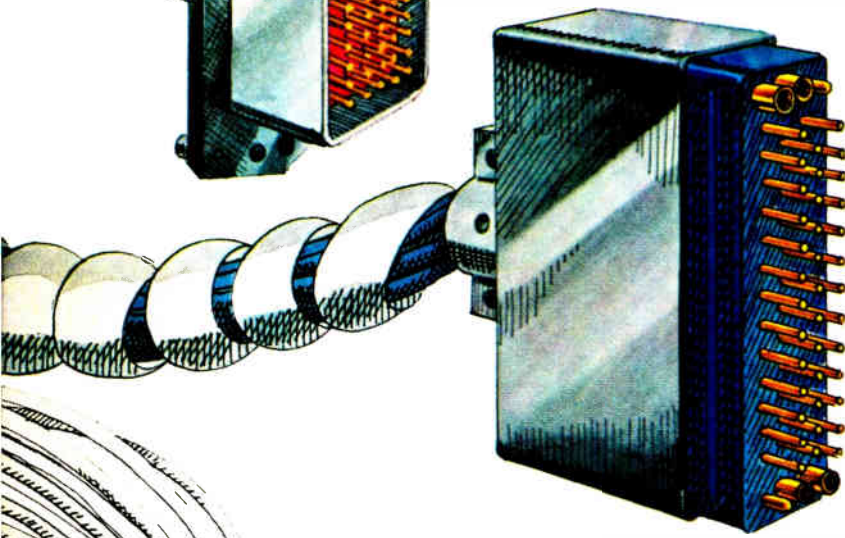
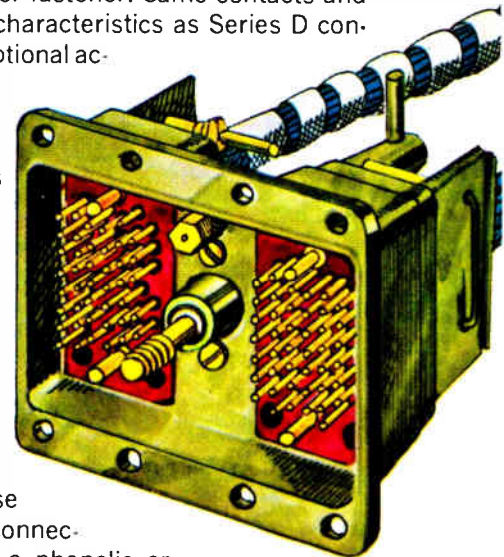

Series M. Least complicated of all, these pin and socket connectors consist of a phenolic or diallyl phthalate block and snap-in contacts. They accept a number of contact types, including subminiature COAXICON* coax contacts. Available with pin hoods, cable clamps, polarizing pins. From 14 to 104 positions per connector. Meets MIL-C-8384.

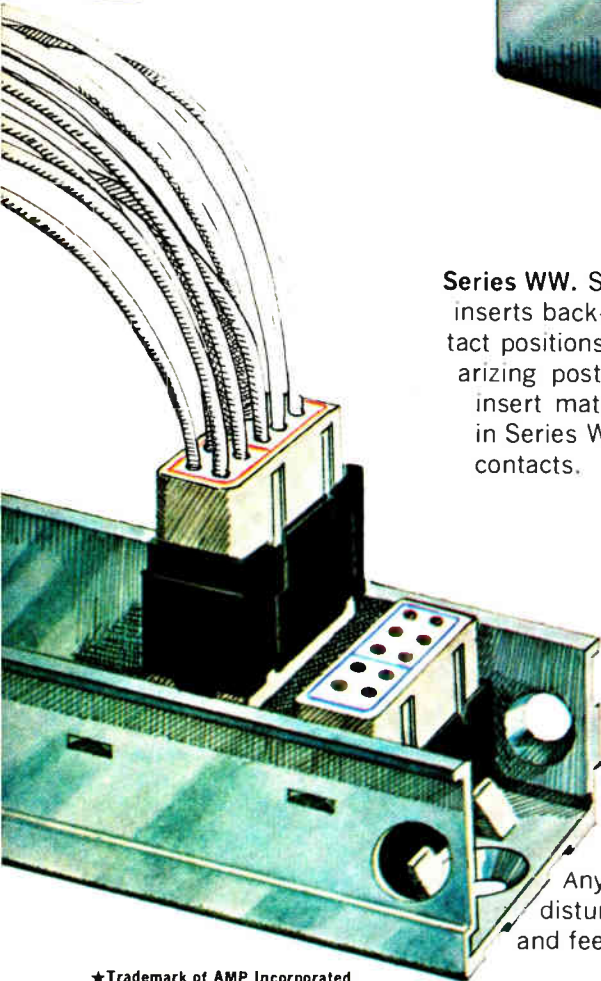

Series WW. Shells incorporate two Series W inserts back-to-back, provide up to 90 contact positions. Center fastener. Three polarizing posts prevent mismatching. Same insert materials and contacts as used in Series W connectors. Accepts coaxial contacts.

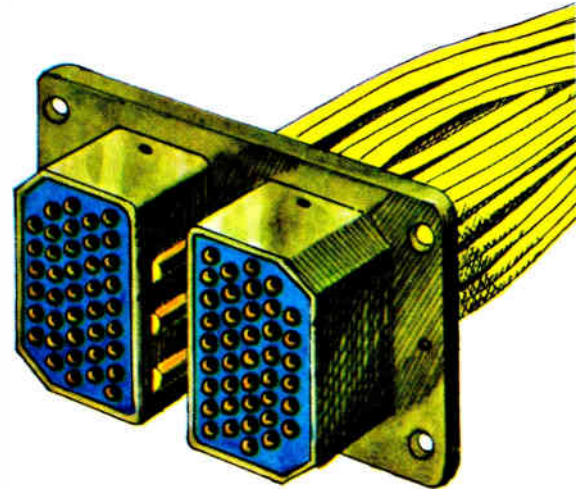

TERMI-BLOK* terminal junction modules. Revolutionary sealed modular commoning system for flexible wiring in airframe, aerospace, and ground support equipment. Vibration-proof modules. Triple-sealed. Positive contact retention. Three module sizes accept wire sizes 24 thru 12 AWG. Up to 400°F continuous operating temperature. Any module removable without electrically or mechanically disturbing other modules. High density, weight-saving feed-to and feed-thru bussing and splicing.

*Trademark of AMP Incorporated

connectors

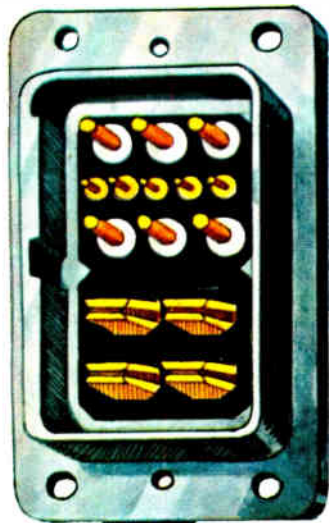

ARINC type. Fully environmental rack and panel connector with crimp, snap-in, front-extractible contacts. Intermateable with present ARINC connectors. Dual-spring socket contact assures consistently reliable performance under vibration and overload conditions. Silicone sealed front and rear. Hard dielectric clip and contact retainer. Contacts crimped, inserted and extracted with MS tooling. Automated tooling available. For any plane that flies.

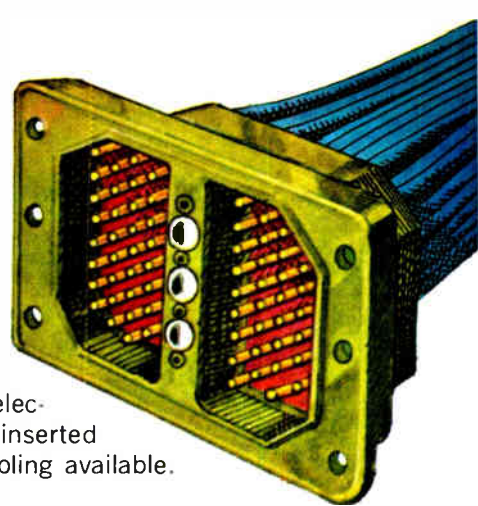

Series G. Versatile modular connector. Various module styles accept several types and sizes of pins and sockets. Snap one, two, or three module inserts into the die-cast aluminum housing. Snap in dependable crimp type contacts. High-speed assembly tooling assures lowest installed costs. Mix power contacts and coaxial circuits. For 32 thru 8 AWG wire sizes.

Series D. Rectangular pin-and-socket connector with glass-filled diallyl phthalate inserts in aluminum shells. Accepts five types of solderless snap-in contacts in various sizes from 10 thru 20, including subminiature coax contacts. Gold over nickel plating on contacts. Raised cavity identification. All parts made of non-magnetic materials. Maximum operating temperature +150°C, minimum -65°C. Meets MIL-C-21617 specifications. Available with up to 78 contact positions.

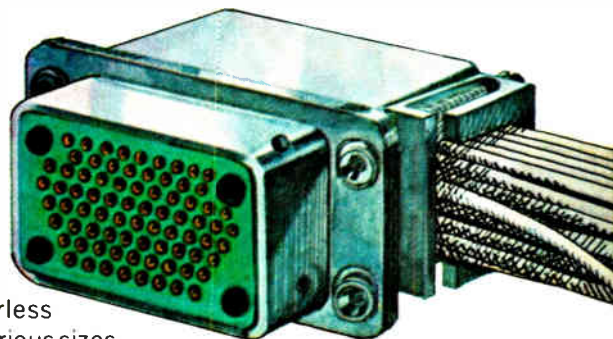

Series W. High reliability aircraft and military connector. Polarized shell of die-cast aluminum. Diallyl phthalate inserts provide excellent mechanical and electrical properties. Crimped pin and socket contacts of various types and sizes 20 thru 16 snap into housings from rear, are easily removed. Cantilever contact in each socket provides constant contact pressure. AMP's automatic crimping machines permit application rates of more than 2,000 contacts per hour.

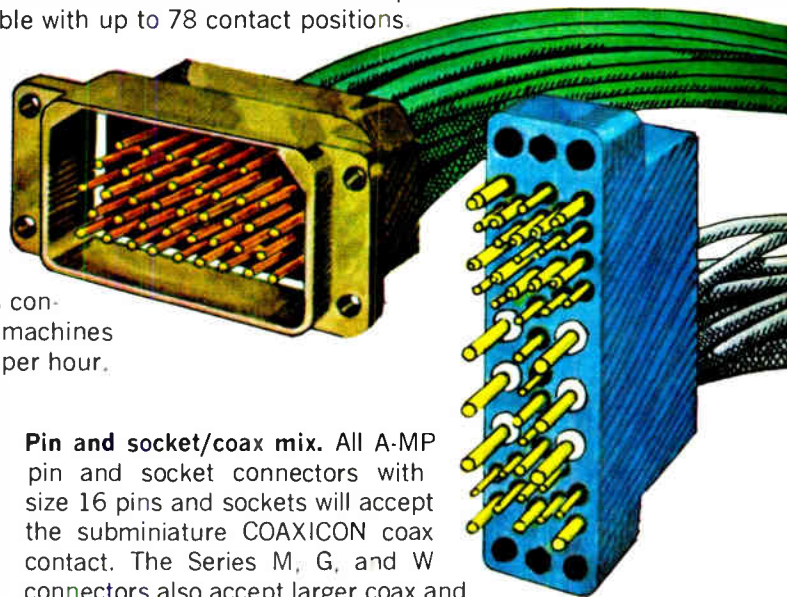

One of a family of automatic and semi-automatic machines for high-speed application of contacts.

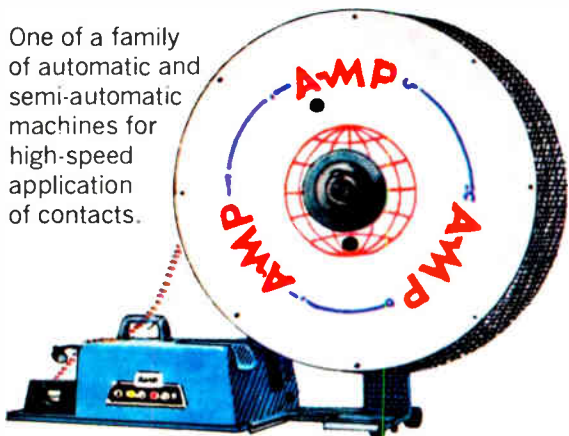

Pin and socket/coax mix. All A-MP pin and socket connectors with size 16 pins and sockets will accept the subminiature COAXICON coax contact. The Series M, G, and W connectors also accept larger coax and twin coax contacts. COAXICON contacts are applied with a single stroke, fit most types of miniature RG/U and shielded cable. As many as 156 coaxial and pin or socket contacts may be mixed in any pattern. For more information, write AMP Incorporated, Harrisburg, Pa. 17105.

...all from AMP

Which IC Test System does all these things?

DIAGNOSTIC COMPUTER PROGRAMS automatically check out system operation.

DATALOG A FORCING FUNCTION, such as the input threshold level of a flip-flop needed to produce a specified output.

TYPED SUMMARY SHEETS. Whenever desired. No interruption in testing. Give total units tested per test station, test yields and bin yields.

DIRECT ENGLISH data logging type-out, showing job name, serial number, test number, decimal point and units.

ABSOLUTE SOURCE CONTROL. Sources can be turned ON or OFF and changed in value in any sequence with variable delays from 100 μ sec. to as long as you please.

DATALOG at any test station—without slowing down classification tests at any other station.

MULTIPLEXING. Several jobs simultaneously. Any assigned, at any time, to any test station.

AUTOMATIC SELF-CHECKING assures accurate data transfer between operator, teletypewriter, computer and test instrument.

VERY COMPLEX TEST SEQUENCES can be programmed, yet preparation of simple tests can be learned in two hours.

GROWING LIBRARY of improved software packages to insure against obsolescence.

FAST TESTING. 1.5 msec per test. If crosspoint is changed, 5 msec. 10 msec on the lowest current scales.

TEN-YEAR GUARANTEE for all instrument plug-in circuitry (it's almost all plug-in).

NO ADJUSTMENT OR CALIBRATION POINTS. (Eternal vigilance is the price you pay for a single adjustment.)

OPEN AND SHORTED CONNECTIONS and **OSCILLATIONS** are automatically detected. System stops when a selected consecutive number of these occur.

COMPLETE FRONT PANEL DISPLAY at any desired step, simultaneously indicating all crosspoint connections, forced values, measured limits, binning decisions—everything about each test.

MINIMIZED REPETITIVE INSTRUCTIONS for the operator through data libraries, variable word length programming, and autotyping.

PROGRAMMABLE CURRENT LIMITS for each source at each test.

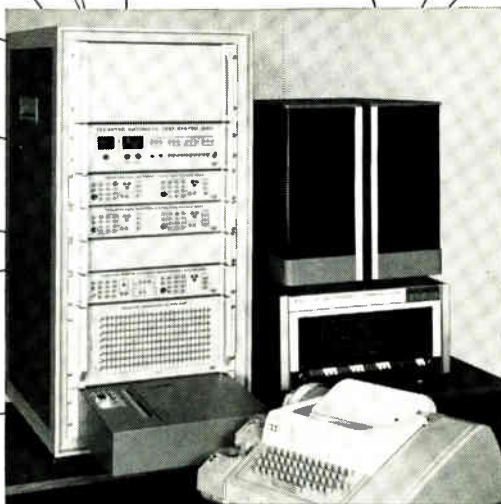

This one.

(complete for only \$65,000)

This is our J259 computer-operated Automatic Circuit Test System. It includes a general-purpose digital computer, teletypewriter, test instrument (comprising modular elements: 24 x 8 crosspoint matrix, four volt-

age sources, measurement system, and test deck), complete software package, and courses in IC testing, system operation, and maintenance. TERADYNE, 183 Essex St., Boston, Mass. 02111 Phone (617) 426-6560.

TERADYNE

Editorial comment

Getting your money's worth

A dollar's value for each dollar spent is the goal of the conscientious designer. In the case of the designer for the military and for most industrial markets, that value is measured in functional performance in preference to esteem or trade-in value. The latter can be important for the consumer market.

More than 20 years ago the General Electric Co. developed the technique of value analysis—"a specific set of techniques, a body of knowledge, and a group of learned skills"—aimed toward eliminating costs which do not contribute to performance, quality, life, or appearance. The military helped value analysis gain acceptance, particularly over the past 10 years, by writing its requirements into procurement contracts.

Value analysis, by common definition, is applied after the fact; that is, one takes a look at an existing product to see if parts can be eliminated or combined, or whether it can be modified to use standard parts, or whether it can be changed to take advantage of automation. It's a rare product that cannot be improved through redesign; yet fewer redesigns might be necessary if value analysis were applied earlier in the original design cycle. When this is done, the technique is called value engineering. Some designers put down value engineering. They say "this is what should have been done in the first place."

Donald Herzog, formerly an engineer and product planner in the aerospace and electronics industry and now a consultant, emphasizes that the objective of value engineering is to look at the function, then design and manufacture the product to perform its function at the lowest possible cost.

The Defense Department includes these elements as part of value engineering:

- Select the product (not all are worth applying value engineering)
- Define the function
- Develop alternate ways of implementing the function
- Analyze the costs of the alternatives
- Verify that the alternative chosen will not degrade performance

It is the Defense Department's intention to share with its contractors any savings that accrue from using value engineering. Sometimes the incentives are no more than a carrot on a stick and occasionally the contractor makes even less than he would have without value engineering. To forestall this unwanted result, instructions have been written to augment basic DOD procurement documents.

Designers who have been indoctrinated in the concepts of value engineering may be tempted to apply it too soon. Herzog warns that to maximize savings, value engineering ought to be applied as early as possible in the life cycle of a product, yet premature use could mean effort wasted on a product that does not meet even preliminary design goals. Furthermore, it is often easier to evaluate a product for value engineering if it exists in physical form. The upshot is that value engineering is usually best applied somewhere between preliminary design and production.

The benefits of value engineering can be handsome. For the Government or other customer it can mean lower cost. For the contractor it can mean higher profits, and his successful application of value engineering weighs in his favor in getting follow-on or new business.

The Standard of Excellence



Diamond Bracelet by J. E. Caldwell Co., Philadelphia—\$17,000.

Silverline Synchros by CLIFTON

The Top of the Line—that's Silverline!

There simply are no production line synchros as good available.

5' accuracy; 3' units available. Guaranteed, in quantity, through design rather than on a "pick and choose" or yield basis.

Outstanding repeatability. Once the error curve has been obtained it holds that original pattern.

Temperature stability and extend-

ed range. EZ shifts are limited to 3' over a standard temperature range of -55°C to 150°C (instead of 125°C). Units available for ambients up to 232°C .

Lower Null Voltages. On Silverline 26 volt CX's, CT's and CD's max total nulls are 20mv.

You expect Clifton to be a little bit better. When you specify Silverline, you're getting the best.

CLIFTON 
DIVISION OF LITTON INDUSTRIES

Call your Local Clifton Sales Office, or telephone 215 622-1000 for prompt service.

Electronics Newsletter

July 8, 1968

Amelco to change marketing stance

Long known as a specialty house, Teledyne's Amelco Semiconductor division is changing its marketing practices and will try to get some of the big production orders that have been the bread and butter of Teledyne's Continental Device Corp. **Instead of concentrating on the introduction of proprietary devices, Amelco will second-source large IC makers.**

The change in direction reflects the influence of James P. Hynes, a former Continental vice president who succeeded Joseph S. O'Flaherty, vice president of both Continental and Amelco, when O'Flaherty retired early this year. Continental specializes in fast production of diodes and transistors.

Amelco will continue to supply Teledyne with circuits for the Integrated Helicopter Avionics System and **will try to maintain its strong position in field effect transistors.** But it has sharply cut back those marketing efforts that stressed the advanced nature of its products. Amelco has its own brand of TTL, but it is also making the Texas Instruments low-power series 54/74, and it will second-source Fairchild on the 9040 line of low-power TTL's for military and space markets.

Honeywell readies industrial computer

Honeywell is developing a new computer for the industrial market, but officials at the company's Computer Control division in Framingham, Mass., won't confirm this. Dubbed the X-9 in its present experimental version, the computer will be called the DDP-316 when it's released for production. **The 316 will be structurally similar to Honeywell's 516, but will have a longer cycle time: 5 microseconds.** A prospective user of the 316, an applications engineer, says he has been promised the computer "next month" since February, **but it probably won't be on the market until next year.**

The target price for the 316, with 4,000 words of core memory, is \$10,000. Similar computers sell for less. However, the applications engineer—who uses and likes the 516 but doesn't need its speed—expects to offset any higher price by being able to use his \$70,000 516 software package on the 316 without modification.

Lower cost PDP-8

By eliminating "frills" from its economy computer, the PDP-8I, Digital Equipment has designed an even lower-priced model, the PDP-8L. At \$8,500, the PDP-8L will be the least expensive 12-bit general-purpose computer available. The L model is slightly slower, offers less input-output flexibility, and has fewer computing functions in the hard-wired form than the I model, which sells for about \$12,800. Deliveries of the L model are due to begin in October.

Discretionary LSI gets a job

For the first time, a full-slice LSI circuit using discretionary wiring has been delivered and put to work. Ten of these 700-bit transistor-transistor-logic shift registers are being used by Texas Instruments in the signal-processing section of a moving-target indicator. Flight tests of the system are under way now; TI is competing with several firms for a military contract for the system.

The arrays, developed by TI, have about 3,000 transistors on a 1¼-

Electronics Newsletter

inch-diameter wafer and can operate from d-c to 10 megahertz. Competitive MOS designs, say TI officials, can operate over part of that range, but not over all of it.

The TI arrays are the same as those used in the general-purpose airborne computer it's developing for the Air Force [Electronics, June 24, p. 47]. An even faster array—operating up to 15 Mhz—is being developed at TI. It includes three kinds of TTL circuits—clocks, registers, and output buffering devices.

FCC to regulate phone companies' CATV leasebacks

CATV operators see a victory in the FCC's decision last month requiring phone companies to obtain commission approval before getting involved in cable-tv leasebacks. In a leaseback, the phone company sets up the system and leases it to the operator. Operators have told of facing protracted delays or unsatisfactory offers in talks with phone firms, and the FCC in effect bought these complaints by stating that phone companies have been able to "preclude or substantially delay" CATV.

The operators feel that bringing the telephone CATV efforts under FCC control—which also implies price regulation—will mean they'll be able to appeal to the agency if a phone company proves too difficult to deal with.

Fairchild starts selling silicon

Fairchild Semiconductor has started to supply silicon ingots and wafers—thus nearly doubling in one stroke the silicon available to semiconductor makers. A doubling of silicon inventories during a switchover to 2-inch wafers, plus the company's virtual departure from the power transistor business (which accounted for most of its epitaxial wafer production), has left its huge wafer-making, slicing, and polishing facility perking along at a mere third of capacity for the past six months. But William H. Welling, headquarters marketing manager, says Fairchild isn't merely selling its excess capacity; it's in the business for good.

8,800-watt laser

Raytheon continues to lead the field with high-powered carbon-dioxide lasers. Scientists at its Research division in Waltham, Mass., have generated 8,800 watts, continuous wave, with a 40-foot design. The laser, made up of 15 plasma tubes, has an effective lasing length of 600 feet. Efficiency of the system is 15%.

Award due for giant pulse-power machine

A \$2.5 million contract to develop the world's most powerful pulsed-power generator for the Defense Atomic Support Agency (DSA) will soon be announced by Physics International Inc. of San Leandro, Calif.

The contract follows a one-year feasibility study by the company of DASA's Aurora simulation facility, which will be built in Washington. Physics International will supply equipment to generate 3 to 4 megajoules in less than 1 microsecond. The pulses must be reproducible 40,000 to 50,000 times, and the pulsed power will be the equivalent of a billion watts.

The project's manager, Frank Ford, explains that the earlier designs were used to simulate temperatures and pressures generated by nuclear explosions, producing power an order of magnitude greater than the output of any previous machine. The contract is nonclassified; many of the earlier pulsepower machines were made for classified projects.

TTL Trends

from Texas Instruments

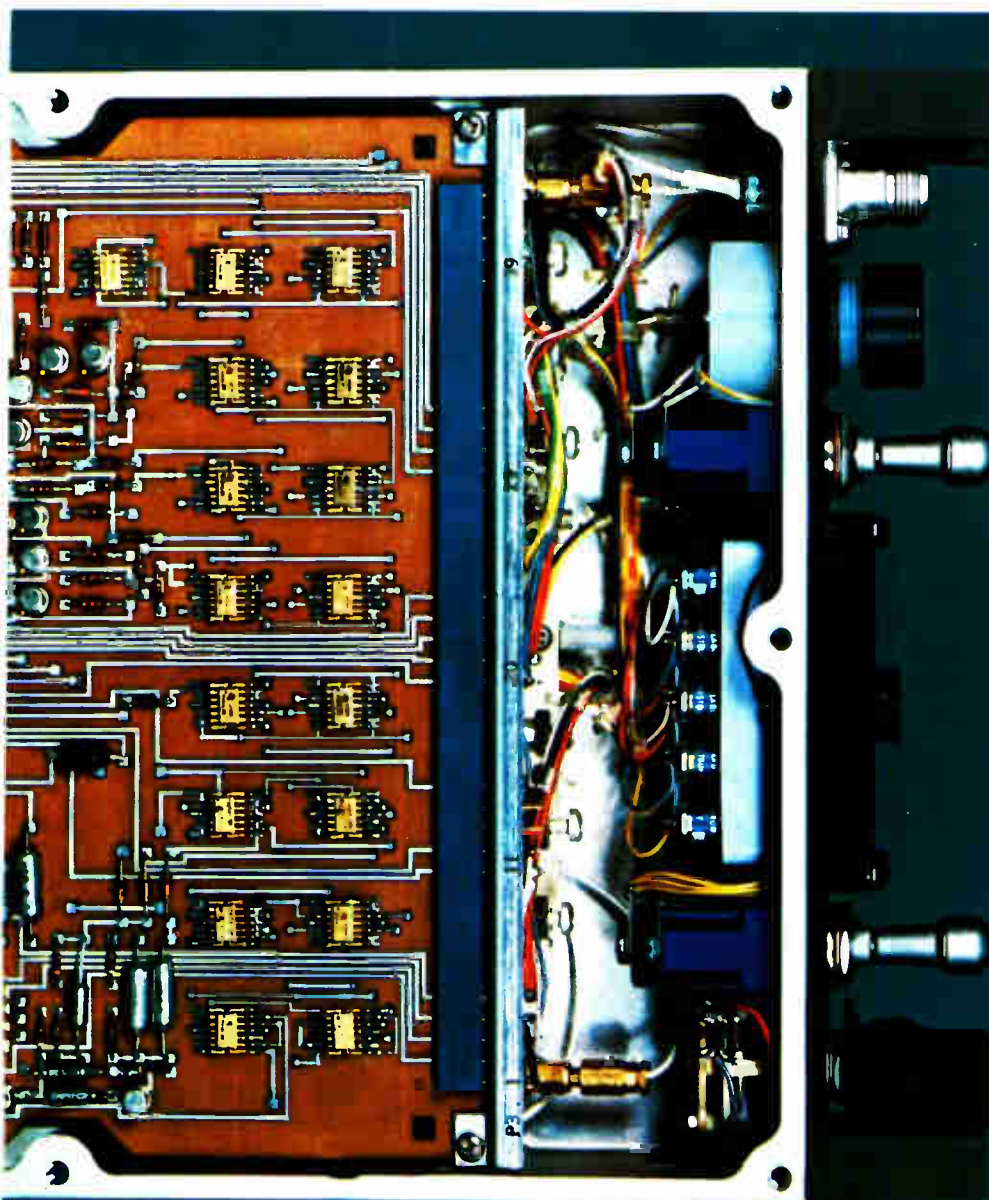

Linking soldier to satellite . . . that's the job for these seventeen low-power TTL integrated circuits from Texas Instruments. They help form the "intelligence center" for an *Alert Receiver Terminal* — part of an advanced new communications system being developed by Collins Radio Company for the Tri-Service TacSatCom (Tactical Satellite Communications) program. Prototype receiver terminals are being built for the U. S. Army under a Tri-Service contract administered by the U. S. Air Force's Electronic Systems Division. Collins engineers use 54L circuits in achieving a portable and lightweight receiver capable of unscrambling messages from a satellite 22,000 miles away. Weighing only 12.8 pounds (with battery) and just 8" by 11" by 2" in size, the Alert Terminal is designed for battlefield use. It is made to go where the soldier goes — detecting, decoding and verifying satellite-relayed digital messages — to get the "word" out . . . fast!

Low-power TTL unscrambles satellite messages



Objective: Demonstrate that a man-carried satellite receiver can effectively get the "word" out—to widely dispersed soldiers—fast!

Approach: Book-size digital receivers are being developed to detect and display coded messages dispatched from distant ground stations and relayed by satellite. Prototype models are now being built by Collins for the Tri-Service system. Each receiver uses 17 Series 54L low-power TTL integrated circuits from Texas Instruments. Included are: Six SN54L71 R-S master-slave flip-flops, four SN54L00 quadruple 2-input NAND gates, six SN54L20 dual 4-input NAND gates, and one SN54L30 8-input NAND gate.

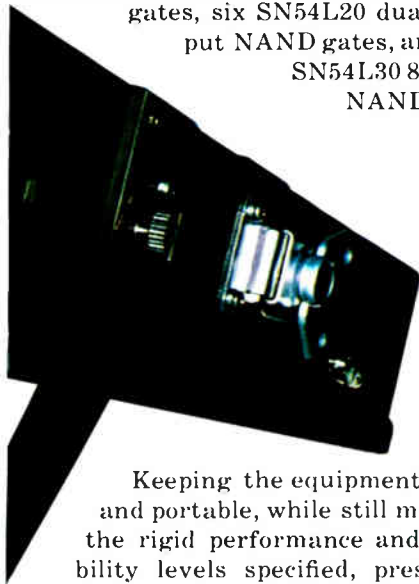

Keeping the equipment small and portable, while still meeting the rigid performance and reliability levels specified, presented extremely tough design problems. A high performance level is essential in decoding and displaying messages weakened by 44,000 miles of space travel. Series 54L circuits provide positive triggering with low-signal currents under severe conditions of humidity, dust, shock and vibration—at temperatures as low as minus 40°C.

Another requirement is to make the receiver—plus batteries—small enough to be carried by one man. The low power drain of Series 54L, only one-tenth that of standard TTL, helps keep down battery requirements while small size and low package count helps hold overall receiver size to only 8" x 11" x 2". With battery, the equipment weighs only 12.8 pounds.

While the Alert Terminal can be carried and set up by one man, it can also be incorporated into any of three larger and more versatile systems Collins is building for TacSatCom. These units can transmit and receive voice and teletype as well as coded messages. All systems operate in the UHF band of 225 to 400 MHz and are engineered to meet the same critical performance and reliability standards.

Based on acceptance by the Department of Defense, TacSatCom—including the Alert Receiver Terminal and other sophisticated system components—can be operational by the early '70's. The complete system will make possible voice and teletype communication to hundreds of mobile receivers without the formal procedures, interference and waiting periods confronting present satellite communication users.

The task of helping link soldier to satellite is a tough, new job for integrated circuits. It's the sort of job that requires outstanding reliability...along with an optimum balance of signal power and low temperature operating capability. In short, it's the kind of job made to order for Series 54L/74L TTL integrated circuits from Texas Instruments.

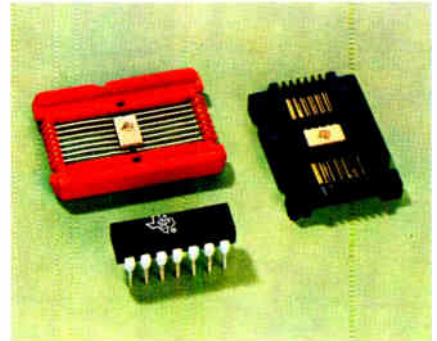

New plastic package, two new complex-function circuits, expand low-power TTL line

TI now offers its Series 54L/74L low-power TTL integrated circuits in dual-in-line plastic packages... with bonus results. The line's low drive requirements and low power dissipation are now coupled with the low first cost and reduced handling costs of the plastic package. This is in addition to the popular long-lead hermetic flat pack (available in either the Mech-Pak™ or Barnes carrier) as shown above.

TI's low-power series is also more versatile than ever, thanks to two new complex-function circuits. These include a dual J-K master-slave flip-flop (SN54L78/74L78) and an eight-bit shift register (SN54L91/74L91). Together they now bring the extra reliability and lower cost-per-function of complex-function ICs to military and industrial low-power applications.

For data sheets on the entire family of low-power TTL, write on your company letterhead to Texas Instruments Incorporated, P. O. Box 5621, MS 980, Dallas, Texas 75222.



TEXAS INSTRUMENTS

INCORPORATED

Dual 50-bit static shift register highlights eight new MOS ICs

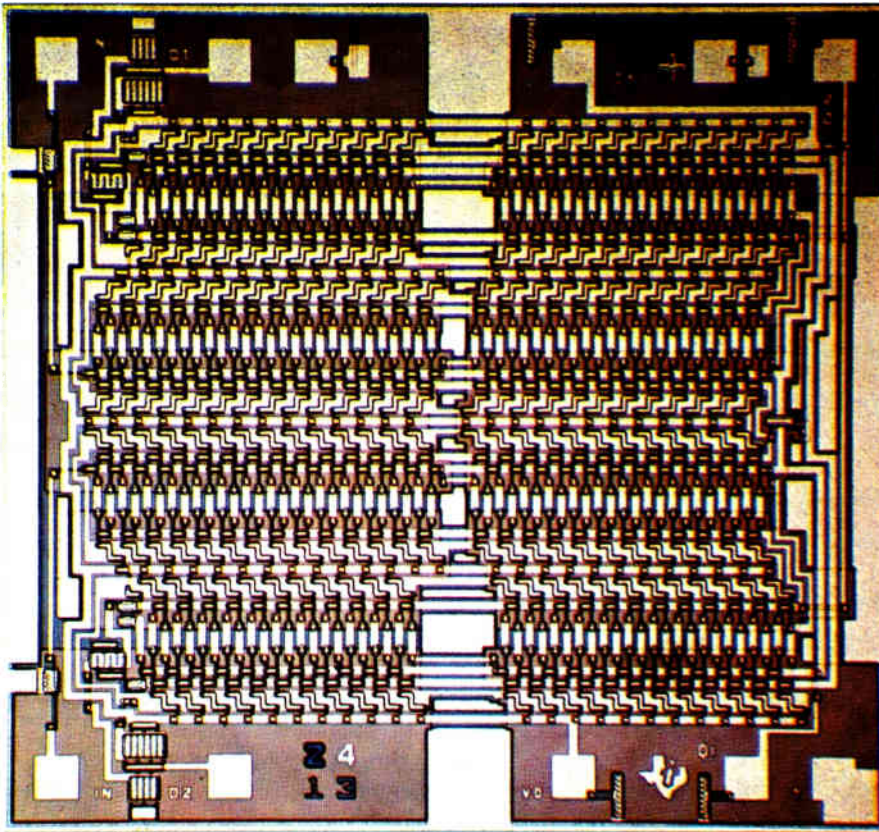

This is a photomicrograph of the longest static shift register available in a production device today. It's TI's new dual 50-bit MOS IC...one of eight new computer-designed circuits. Companions include three other dual SRs (32, 25 and 16 bit), a six-channel analog switch, an audio amplifier, a dual full adder, and a dual 3-input NOR gate.

For your moderate speed digital applications, TI's new MOS integrated circuits can offer significant savings. For example, cost-per-bit for these MOS static shift registers is only about one-fourth that of bipolar registers.

All four new MOS static regis-

ters operate over the full d-c to 1 MHz spectrum (3 MHz under moderate loading). Unlike dynamic registers with a minimum clock rate, these static MOS circuits can store information for relatively long periods. They also possess high noise immunity, because of high input

impedance, typically 10 megohms.

The dual 50-bit static register features very low power drain of only 1.6 mW per bit. Furthermore, longer static MOS registers and specially tailored units can be readily provided...thanks to TI's computer-aided design which makes custom derivatives possible in economical and timely quantities.

Six-channel analog switch

To permit switching of lower-level signals without excessive attenuation, the TMS 1A 6009 AA features low "on" resistance (150 ohms).

It is recommended for analog and time-division multiplexing, and chopping circuits.

Audio amplifier

Small size and modest cost make the TMS 7A 7000 LA ideal for many industrial and consumer applications. It is an R-C coupled audio amplifier with a gain of 45 dB over the frequency range of 10 Hz to 50 kHz. Output voltage swing (8 volts peak-to-peak) is obtainable with a single -20 to -30 volt power supply.

Dual full adder and dual NOR gate

High input impedance, buffered outputs and high noise immunity are characteristics of the TMS 1A 1700 AA dual full adder and TMS LA 1702 dual 3-input NOR gate.

For data sheets on any or all these new MOS ICs, write on your letterhead to Texas Instruments Incorporated, P. O. Box 5621, MS 980, Dallas, Texas 75222.



TEXAS INSTRUMENTS
INCORPORATED

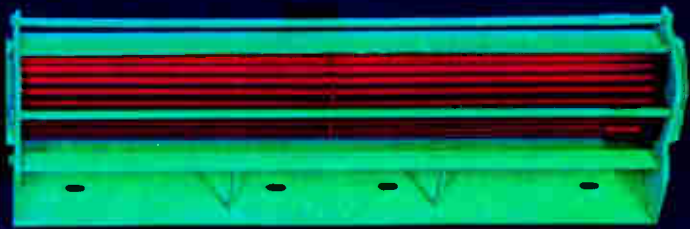
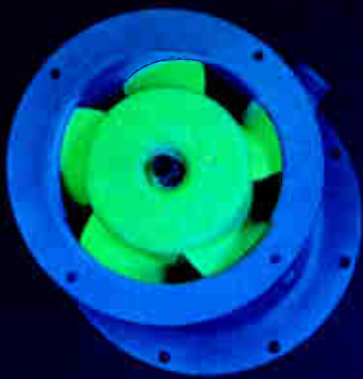

Torrington

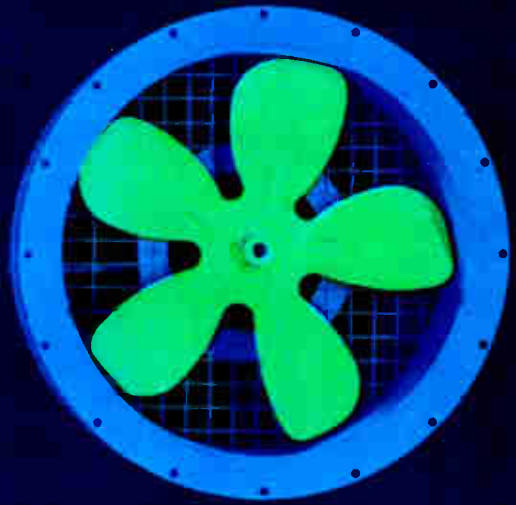

makes a few colorful claims

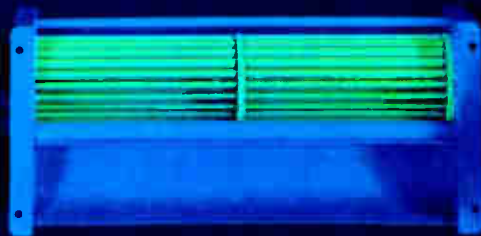

for its blower line.



We've painted these Torrington blowers to illustrate some points. Torrington makes about as many different types of blowers as there are colors in the spectrum. Backward and forward curved, single or dual centrifugal units, tube axials, vane axials, single or multi-staged turbine-driven units, Crossflo's[®] and you-name-it-we'll-make-it units.

We'll not only produce any type you require (many standard in our line), but we'll make them in an almost endless range of sizes to meet your application needs. Between Torrington's vast productive capabilities at home and abroad and the technological know-how of its engineers, no problem's too big or too small.

Like a more detailed account of what modern blowers can do for you? Send for our 24-page reprint from a major industrial publication. Profusely illustrated with charts, drawings and photographs, it shows and describes every type of blower made.

Write today, to The Torrington Manufacturing Company, Torrington, Connecticut.

TORRINGTON MANUFACTURING COMPANY

United States: Torrington, Connecticut VanNuys, California Rochester, Indiana Canada: Oakville, Ontario England: Swindon, Wilts Belgium: Nivelles Australia: Sydney

25 F. 8.6

Allen-Bradley hot-molded trimmers

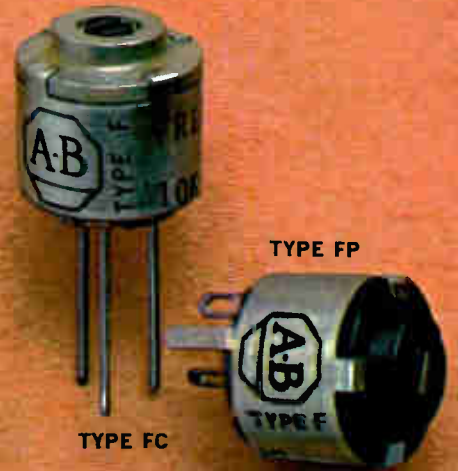

TYPE N

TYPE RP

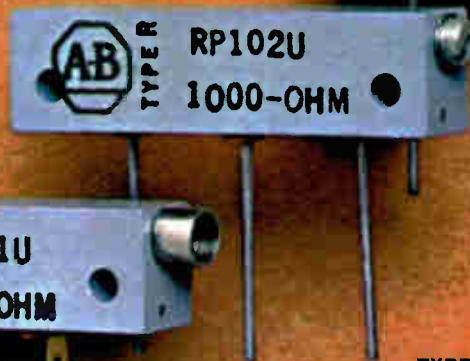

TYPE RC



TYPE RH

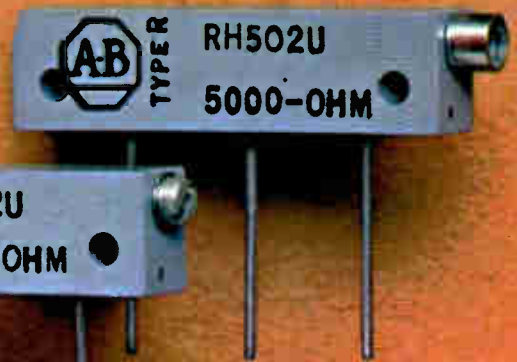

TYPE RS



TYPE RK



1167E-2

TYPE YH



TYPE YS



TYPE YR



TYPE YC



TYPE YN



best in "set" ability...best in "hold" ability

This family of Allen-Bradley trimmers features a solid resistance track made by A-B's exclusive hot-molding technique. This solid resistance element assures smooth adjustment at all times. It approaches infinite resolution—there are never any of the abrupt changes in resistance which introduce transients as is characteristic of wirewound controls.

When Allen-Bradley hot-molded trimmers are once set, they will remain stable during severe

mechanical shock and vibration. In addition, A-B trimmers have low distributed capacitance and are essentially noninductive, permitting their use at high frequencies where wirewound units are totally useless.

For complete specifications on these high performance trimmers, please write: Allen-Bradley Co., 110 W. Greenfield Ave., Milwaukee, Wis. 53204. In Canada: Allen-Bradley Canada Ltd. Export Office: 630 Third Ave., N.Y., N.Y., U.S.A. 10017.

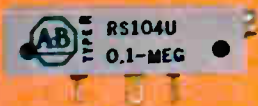

Type R trimmers are ruggedly built to maintain their settings under severe shock and vibration. Continuous resistance change is provided over 25 turns of the adjustment screw. Enclosures are dust-tight and watertight. Long operational life—accelerated tests produce less than 5% resistance change after 500 complete cycles (25,000 turns of the actuator). Rated $\frac{1}{4}$ watt at 70°C, and can be applied in temperatures from -55°C to $+125^{\circ}\text{C}$. Available in resistance values from 100 ohms to 2.5 megohms. Write for Technical Bulletin B52C5.

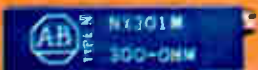

Type N trimmers are similar to the Type R units, and provide substantial economies where environmental conditions are not excessively severe. The 25-turn adjustment screw permits precise settings. The operational life is the same as the Type R. The enclosure is dust-tight and immersion-proof. The rating is $\frac{1}{3}$ watt at 50°C and can operate in ambient temperatures from -55°C to $+100^{\circ}\text{C}$. Available in resistance values from 100 ohms to 2.5 megohms. Please write for Technical Bulletin B5206.



Type F trimmers are single turn controls built to withstand severe environmental condition. They are $\frac{1}{2}$ " in diameter and are rated $\frac{1}{4}$ watt at 70°C. Can be used from -55°C to $+120^{\circ}\text{C}$. Enclosure is nonmagnetic, corrosion-resistant, and watertight. Available in resistance values from 100 ohms to 5.0 megohms. Various tapers can be furnished. Send for Technical Bulletin B5201.

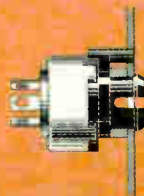

Type Y trimmers are economical single-turn units designed for use where environmental conditions are not particularly severe. The low profile construction allows them to fit easily within the commonly used $\frac{3}{8}$ " stacking. Options for the Type Y include thumb wheel and mount for horizontal installation. Type Y is also made with snap-in mount for panel mounting, as shown in drawing. Rated $\frac{1}{4}$ watt at 70°C. Resistances from 100 ohms to 5.0 megohms. Please write for technical literature.



ALLEN-BRADLEY
QUALITY ELECTRONIC COMPONENTS



Pushbuttons?

Why not go where you have the whole spectrum to choose from!

With panel design continually increasing in sophistication, pushbutton specifications are becoming more and more exacting. Whatever the case—whether your needs call for the simple or the complex—your best bet is to call MICRO SWITCH. The reason is plain. No one can match our pushbutton line in breadth of selection.

What's more, your MICRO SWITCH Distributor can offer you literally thousands of pushbutton varieties *right off the shelf*. For example, he stocks hundreds of interchangeable operator and switch modules that combine into thousands of different assemblies—allowing

you to economically customize your panel with unlimited design freedom.

Special problems? MICRO SWITCH also puts the broadest field engineering service at your beck and call. These pushbutton specialists, backed up by the largest manufacturing and design facilities in the industry, can come up with the right solutions fast.

Just a sampling from our spectrum of pushbuttons is shown at left and described below. For more details, call a Branch Office or an Authorized Distributor (Yellow Pages, "Switches, Electric"). Ask for Catalog 51.

1. Unlighted Pushbutton Switches. Bushing or bracket mounted. Available in 1-, 2-, 3- or 4-pole double-throw circuitry, momentary or alternate action. Black, red and green buttons in various diameters. Scaled designs available. Wide range of electrical power-handling capabilities.

2. Series 2C200 Modular Lighted Pushbutton Switches. Rectangular display lighted by projected or transmitted 4-lamp color. Can be relamped without tools. 1, 2, 3 and 4 section split-display screens. Maintained, momentary or magnetic hold-in operation. Switch modules with silver or gold contacts, multiple circuits and broad choice of contact arrangements and electrical capacities. Also reed switch module.

3. PT Heavy-duty and CMC Pilot-duty Industrial Manual Controls. Oiltight pushbuttons, selectors and indicators with the modern square look. Lighted or unlighted. Large easy-reading legends. Multi-circuit control with up to 32 circuits per unit.

4. KB Switch/Display Matrix. New keyboard building block concept consisting of pushbuttons and pushbars (lighted and unlighted), switches, indicators, mechanical interlock units, and modular hardware for mounting and wiring. En-

tire KB matrix can be bench assembled. Switches can be pre-wired and plugged in like a radio tube. Milliamp-rated "encoding" switch produces a coded output for data entry, exclusive of separate circuit packages. "Power" switch with 5 amp, 115 vac rating has lighted display option.

5. 50PB Bushing Mounted Pushbutton Switches. One-lamp indication. Choice of button sizes, shape and colors. Long- and short-stroke and turn-to-hold momentary action; one- and two-level alternate-action. 1-4 pole double-throw and two-circuit double-break contact arrangement.

6. DM Pushbutton Switches: Attractive, rugged snap-in panel mount. SPDT or

DPDT circuitry. Three snap-on button styles, 1/2" to 1" diameter, red or black. Also 1 1/32" diameter integral momentary-action and push-pull alternate action buttons. Rating: 10 amps, 125 or 250 vac; 1/3 hp, 125 or 250 vac.

7. 302PB Miniature Pushbutton Switches. One- or two-section two-lamp display. Momentary and alternate-action operation of two SPDT switches. Spacing barriers and panel seals available.

8. Series 2N Modular Lighted Pushbutton Switches. Relampable without tools, these switches feature spring-lock mounting. Molded color housings, in gray, white or black, can be supplied with terminals for two or four lamps. Modularity provides a number of circuit, operation and display possibilities paralleling the 2C200 options. Spacing barriers and hold-in coil modules are available.

9. Series 2M Round Display Modular Lighted Pushbutton Switches. Colored guard rings encircle display screen, prevent accidental operation, code control function. Broad choice of circuitry through switch modules used with Series 2N. Many choices of transmitted and projected display colors. Panel mount in 1/16" to 5/16" thick panels.

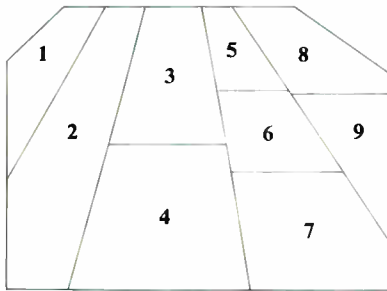

MICRO SWITCH

FREEMONT, ILLINOIS 61032

A DIVISION OF HONEYWELL

TRIMMERS-

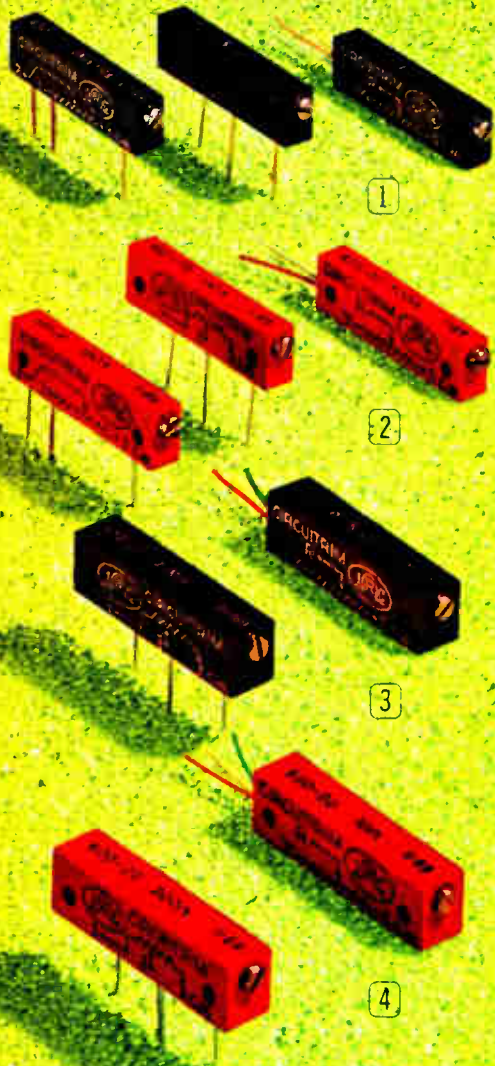

1. **SERIES 450.** Infinite resolution. RJ-12 size. 50Ω thru 1 meg. $\frac{1}{2}$ watt @ 70°C . $\pm 10\%$ tolerance. $\pm 20\%$ available for low-cost needs. Choice of two PC pin arrangements.

2. **SERIES 400.** Wirewound RT-12 C2L or RT-12 C2P size. Also with staggered RT-11 pins for direct replacement while saving space. 1 watt @ 70°C . $\pm 5\%$ tolerance. 100Ω to 100K.

3. **SERIES 650.** Infinite resolution in RJ-11 size. $\pm 5\%$ tolerance. ± 250 -ppm/ $^\circ\text{C}$ over range of 100Ω to 20K. 1 watt @ 70°C .

4. **SERIES 600.** Wirewound RT-11 has MIL quality at industrial prices. Moisture-sealed construction. 1 watt @ 70°C . $\pm 5\%$ tolerance. 10Ω to 100K.

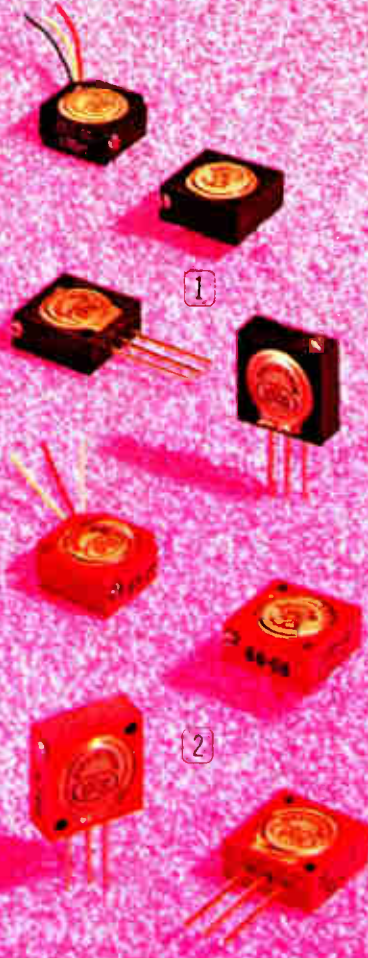

1. **SERIES 255.** RJ-22 styles with infinite resolution. ± 5 , 10, 20% tolerances to meet all your needs. $\frac{3}{4}$ watt @ 70°C . 100Ω to 1 meg.

2. **SERIES 205.** Four RT-22 styles for MIL or high-grade industrial needs. 1 watt @ 70°C . $\pm 5\%$ tolerance. 10Ω to 50K.



1. **SERIES 150.** Infinite resolution companions to wirewound types. Many configurations. $\frac{3}{4}$ watt @ 70°C . ± 5 , 10, 20% tolerances. 100Ω to 1 meg.

2. **SERIES 100.** Largest $\frac{1}{2}$ " round selection. Well sealed for MIL or industrial use. Positive stops. Longer winding for better resolution and closer settings. 1 watt @ 50°C . $\pm 5\%$ tol. 10Ω to 50K.

3. **NEW LOW-COST SERIES 550 and 500.** Most economical $\frac{1}{2}$ watt trimmers for commercial and industrial use. Infinite resolution Series 550 has excellent high-frequency characteristics. $\pm 30\%$ tolerance. 100Ω to 1 meg. Wirewound Series 500 has best resolution at lowest cost. $\pm 10\%$ tolerance. 10Ω to 50K. Vertical mounts available.

All styles available from IRC Qualified Industrial Distributors.

Panel mounting versions available for all styles. IRC also offers hundreds of terminations, mounting variations and adjustments.

only IRC offers all popular styles

NOW...



NEW 3/8" MIL TRIMMERS

Infinite resolution or wirewound types

The simplified design of these new IRC 3/8" MIL units provides precision, stability, and economy in a small, board-hugging package.

A proven clutch assembly assures positive drive of the wiper at all times. These trimmers have molded-in pins, and are sealed to resist moisture. Dielectric strength is a full 1,000V A.C.

METAL GLAZE TYPE 750 offers essentially infinite resolution over the full resistance range from 100Ω to 1 megohm. The glass-hard, thick-film resistance element defies catastrophic failure. MIL-R-22097 performance. Rugged epoxy case.

WIREWOUND SERIES 700 in RT-24 size exceeds all MIL-R-27208 requirements. Silver brazed terminations guarantee 0.25% minimum resistance setting and freedom from catastrophic termination failures. Precious metal wiper. Heat-resistant diallyl phthalate case.

CAPSULE SPECIFICATIONS

	METAL GLAZE TYPE 750	WIREWOUND TYPE 700
POWER:	1/2 watt @ 70°C	1 watt @ 70°C
TOLERANCES:	±10, 20%	±5%
RESISTANCE:	100Ω to 1 meg.	10Ω to 50K
TEMP. COEF.:	±250ppm/°C max. (+25°C to +125°C)	±50ppm/°C max.
TEMP. RANGE:	-65°C to +125°C	-65°C to +175°C

Both types are immediately available and at prices that are lower than you would expect. Write for data on these new 3/8" trimmers. Or ask for our new potentiometer catalog.

1. 3/16" CUBETRIM® Miniature units provide significant space savings for all PC board applications. Infinite resolution Series 350: 0.3 watt @ 70°C. ±10 and 20% tolerances. 50Ω thru 500K. Wirewound Series 300: 0.6 watt @ 60°C. ±5% tolerance. 50Ω to 20K. Both series available with top or side adjust.



DIVISION OF TRW INC.

401 N. Broad St., Philadelphia, Pa. 19108

Circle 45 on reader service card

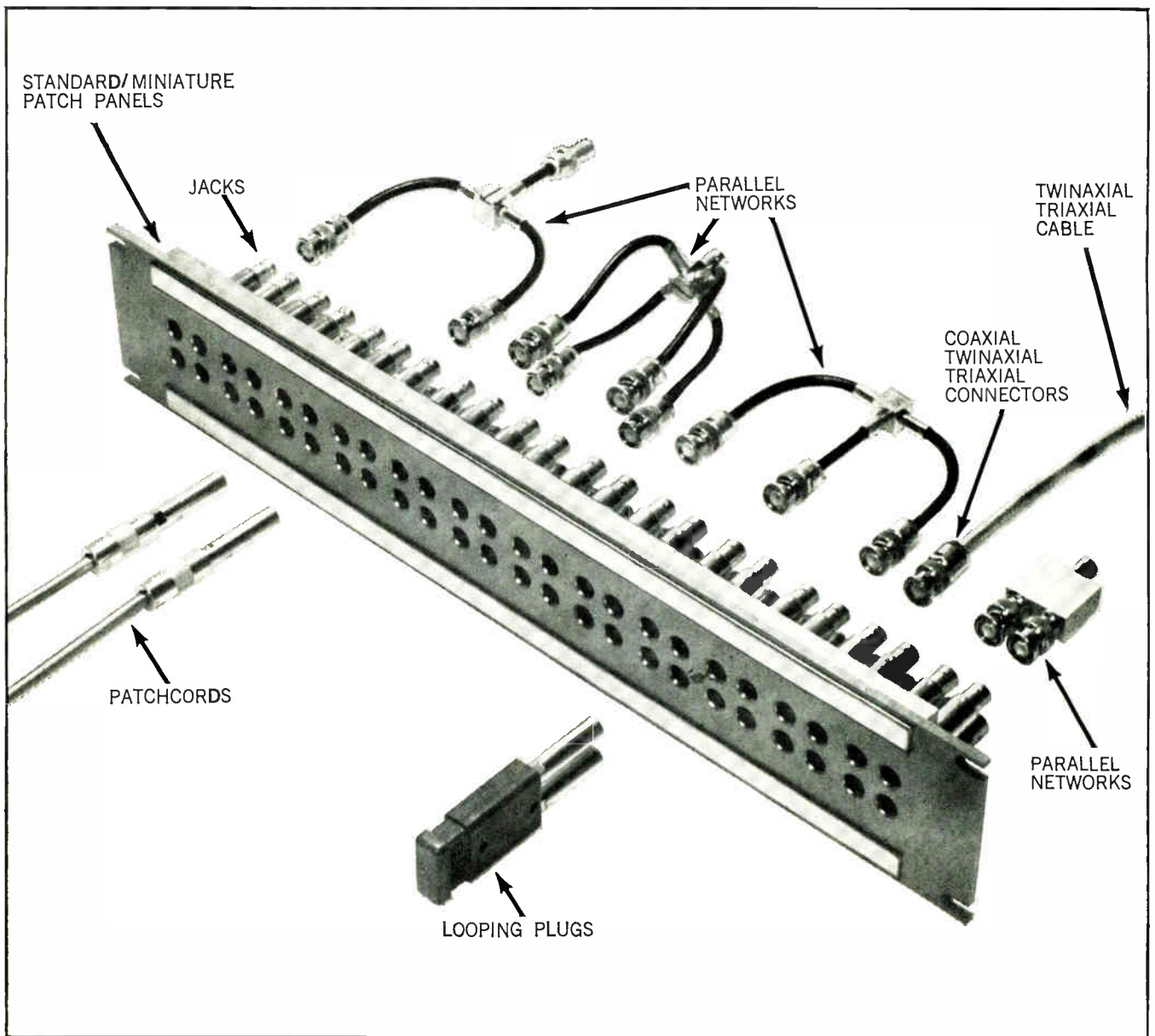

There are probably a thousand different ways to set up a reliable patching system.....which way is the best?

The answer lies between you and Trompeter, the company that specializes in patching and switching. Trompeter has a new colorful 28 page catalog that covers everything from panels, standard and miniature, to hundreds of coaxial, twinaxial, and triaxial patching components. What's more, it has a unique technical discussion on "Noise Pickup in Cable Systems" that will help you design the system best for you. If then, you still have a problem, ask the people at Trompeter, they've been involved with the design of just about every patching system made.

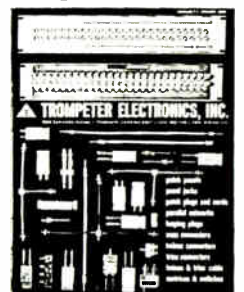

New T-7 Catalog

TROMPETER ELECTRONICS, INC.

8936 Comanche Avenue. □ Chatsworth, California 91311 □ Telephone (213) 882-1020



Is your carbon comp resistor supplier ho-hum about your business?

You'll like the way we document our interest. We're one of the few manufacturers who will furnish you with written data to prove how our resistors meet the requirements of MIL-R-39008. We've also insured that our documentation is fallibility-free, by developing the world's only on-line computerized resistor quality control system. Is the reliability of your present military, aerospace, or industrial resistors something you have to take on faith? Get in touch with us. We can prove what we say, and we also have bright flexible ideas that will keep pace with your requirements. So...

Call the passive innovators at Airco Speer.



Specify TI 709 op amps in low-cost plastic packages now..from Kierulff



It's easy to see why our big stocks of TI 709 IC operational amplifiers are your *best choice* to fill the booming demand. Why? Because only TI gives you complete package versatility, economy and performance. TI features a dual in-line plastic package priced lower than ever before...along with standard flat-pack and TO-5 type configurations. This opens up hundreds of new applications in both industrial and military equipment markets.

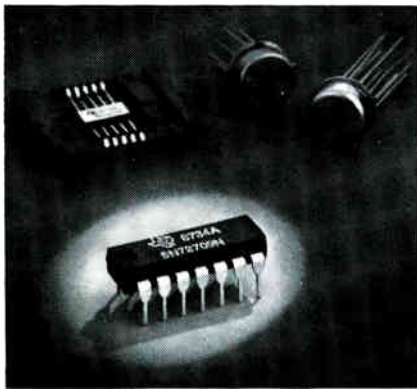

Want performance? Our TI 709s provide high gain, high common mode rejection, high output voltage swing, and low offset. You'll find these devices perfect for instrumentation, process control, computation, and communications.

Want variety? Then consider our TI 702s (high-gain, wide band), 710s (differential inputs and low output impedance) or 711s. Op amps, you know, are the closest thing yet to truly universal circuits.

Check the convenient Linear IC Interchangeability Chart below. You'll find TI circuits are spec-for-spec and pin-for-pin replacements of competitive types. And... we have exclusive low-cost package advantages in many areas!

Make it easy on yourself. Include TI 709 op amps on the requisition you use to order TTL ICs.

Starting with TI's leadership line of TTL integrated circuits, we offer prompt shipment from complete stocks to fill all your IC needs. So call *today*...or circle Reader Service Number 290 and we'll send you a data sheet for the device type you're interested in. This will help you fill the empty spaces in your procurement schedules—fast.

LINEAR IC INTERCHANGEABILITY CHART					
OPERATIONAL AMPLIFIERS					
Texas Instruments	Package	Temp. Range	FSC †	Motorola †	Raytheon †
SN52 702AL SN52 702AF SN52 702AN SN52 702L SN52 702F SN52 702N SN52 702BL SN52 702BF SN52 702BN SN72 702L SN72 702F SN72 702N	TO-99 Flat Pack Plastic Dip TO-99 Flat Pack Plastic Dip TO-99 Flat Pack Plastic Dip TO-99 Flat Pack Plastic Dip TO-99 Flat Pack Plastic Dip	-55 C to 125 C -55 C to 125 C ↓ 0 C to 70 C ↓ -55 C to 125 C ↓ 0 C to 70 C ↓	U5B770231X U3H770231X U3H7702313 U5B771239X U3H771239X U5B7709311 U3T7709311 U5B770931X U3T770931X U3T7709313 U5B770939X U3T770939X U6E7709393	MC1712G MC1712F MC1712CG MC1712CF MC1712CP MC1709G MC1709F MC1709CG MC1709CF MC1709CP	RM 702 RC 709 RC 709
COMPARATORS					
SN52 710L SN52 710F SN52 710N SN52 710BL SN52 710BF SN52 710BN SN72 710L SN72 710F SN72 710N	TO-99 Flat Pack Plastic Dip TO-99 Flat Pack Plastic Dip TO-99 Flat Pack Plastic Dip	-55 C to 125 C ↓ 0 C to 70 C ↓	U5B771031X U3H771031X U3H7710313 U5B771039X U3H771039X U6E7710393	MC1710G MC1710F MC1710CG MC1710CF MC1710CP	RM 710 RC 710
DUAL COMPARATORS					
SN52 711L SN52 711F SN52 711N SN72 711L SN72 711F SN72 711N	TO-100 Flat Pack Plastic Dip TO-100 Flat Pack Plastic Dip	-55 C to 125 C ↓ 0 C to 70 C ↓	U5F771131X U3T771131X U5F771139X U3T771139X	MC1711G	RM 711

† Based on latest available public information

* Dual-In-Line



ELECTRONICS

KIERULFF

A SUBSIDIARY OF DUCOMMUN INCORPORATED

ALBUQUERQUE
6405 Acoma Road, S.E.
Albuquerque, New Mexico 87108

PHOENIX
2633 E. Buckeye Road
Phoenix, Arizona 85034

PALO ALTO
3969 East Bayshore Road
Palo Alto, California 94303



The sudden surge of voltage: How to keep electronic equipment from being damaged or destroyed.

Make no mistake. All solid state circuitry, for example, is highly vulnerable to excessive voltages.

Transients from lightning strikes, static charges, internal switching, short circuits, etc., are a constant danger to the reliability and life expectancy of your equipment.

The least you can do is use Siemens Gas-filled Surge Voltage Protectors. Least in terms of size, weight and price. But most in performance.

Siemens SVP's are the smallest and lightest you can buy. Yet they deliver more protection by providing a higher current carrying capability (up to 5,000 Amps.) than any other proven arc-suppressor in their price range. And they have a virtually instantaneous reaction speed —extending to the nanosecond range.

So why run the risk of damage to unguarded circuits? When Siemens gas-filled protectors cost less than a dollar in quantity and provide long-life protection.

Siemens Surge Voltage Protectors come in many standard models, with a nominal DC striking voltage ranging from 90V to 1000V. Or we can custom-design SVP's for your special applications.

Delivery? Immediate, from our stock in N.Y. Better get more details now. Write:

SIEMENS AMERICA INCORPORATED
350 Fifth Avenue, New York, N.Y. 10001

Product shown approx. 1½ times actual size.

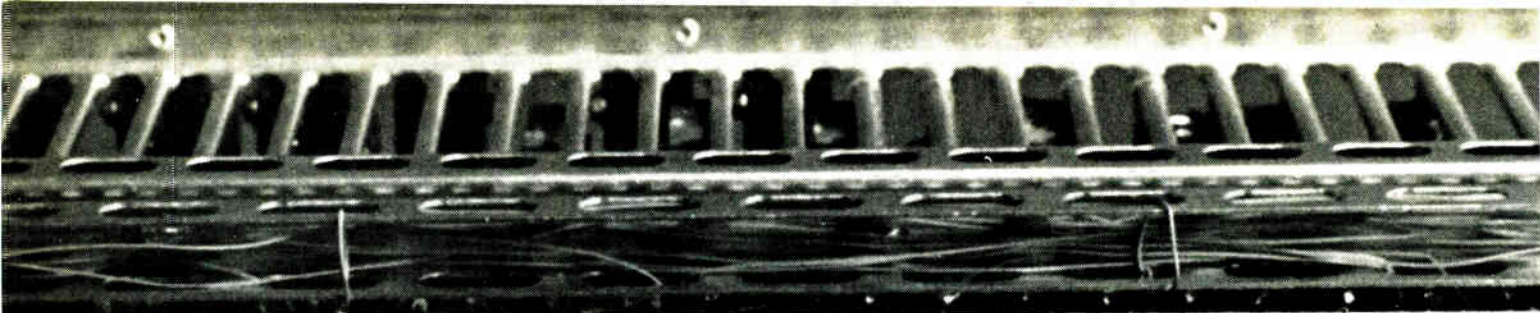

DIGITAL OUTPUT



MULTIPLEXER A

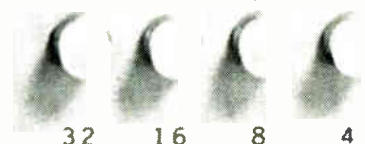

INVERT



CLEAR



STEP



AUTO M

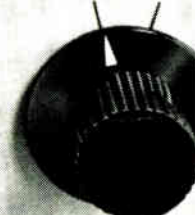

MD51 MU

It's the fastest. It's the most accurate.

The MD51 is a high-level 64 channel multiplexer, a sample and hold amplifier and a 15-bit A to D converter, all in a single chassis. It has a total sample and conversion time of 10 microsec-

onds max. and an accuracy of 0.01%. And it sells for under \$10,000. If that doesn't say it all, write for the rest.

SDS
Scientific Data Systems,
Santa Monica, California

Circle 50 on reader service card

Advanced technology

GaAs on sapphire

Even though silicon-on-sapphire devices are still too new to be widely used, the Autonetics team that pioneered SOS is developing microwave devices using gallium arsenide as the semiconductor material on such insulating substrates as sapphire, spinel (magnesium aluminate), and beryllium oxide.

The group, headed by Ralph Ruth, has produced Schottky-barrier mixer diodes and tunnel diodes using GaAs on sapphire. Ruth is group scientist in the physical sciences department of Autonetics' research and engineering division. He's also one of the prime movers, along with Harold Manasevit, a member of the technical staff, behind a new chemical vapor-deposition process that's fundamental to the diode work. This process is designed for large-area epitaxial growth of single-crystal semicon-

ductor materials—such as GaAs—on both semiconductor substrates and the single-crystal spinel and beryllium-oxide insulating substrates.

So far, no semiconductor devices have been produced on spinel or beryllium oxide substrates, but the Schottky-barrier mixer diode is expected to operate at 10 gigahertz and have a reverse breakdown voltage of about 6 volts at 10 microamperes. Marcian Roth, who is heading the mixer-diode development, says the device has been characterized only for its d-c features so far, although microwave evaluation is under way. He thinks the microwave measurements should confirm the d-c characteristics.

"We'll have a Schottky-barrier mixer diode with an operating frequency of 10 Ghz," Roth maintains, "and we don't know of anyone else who has done this with GaAs on sapphire. The fact that we've made good devices with these materials is significant in it-

self." Roth believes the most significant facet of the development is that the mixer diode arrays are monolithic and compatible with monolithic microwave IC's.

In a hybrid approach, Roth explains, a microstrip would be put down first, then the active devices would be put down on it. Fabrication of the monolithic mixer diode array is compatible with evaporation and photo-lithographic techniques used in the planar process. Basically, a GaAs island is formed by etching to the substrate. A metal semiconductor Schottky barrier is formed, along with an ohmic contact. The next step is to evaporate the appropriate metal microstrip lines onto the sapphire substrate and over the mixer diodes' ohmic and barrier contacts.

Electron mobility. Manasevit says there are variations in the temperatures at which GaAs is deposited on all three insulator substrates, but these are proprietary. Roth notes that GaAs has greater electron mobility than silicon and

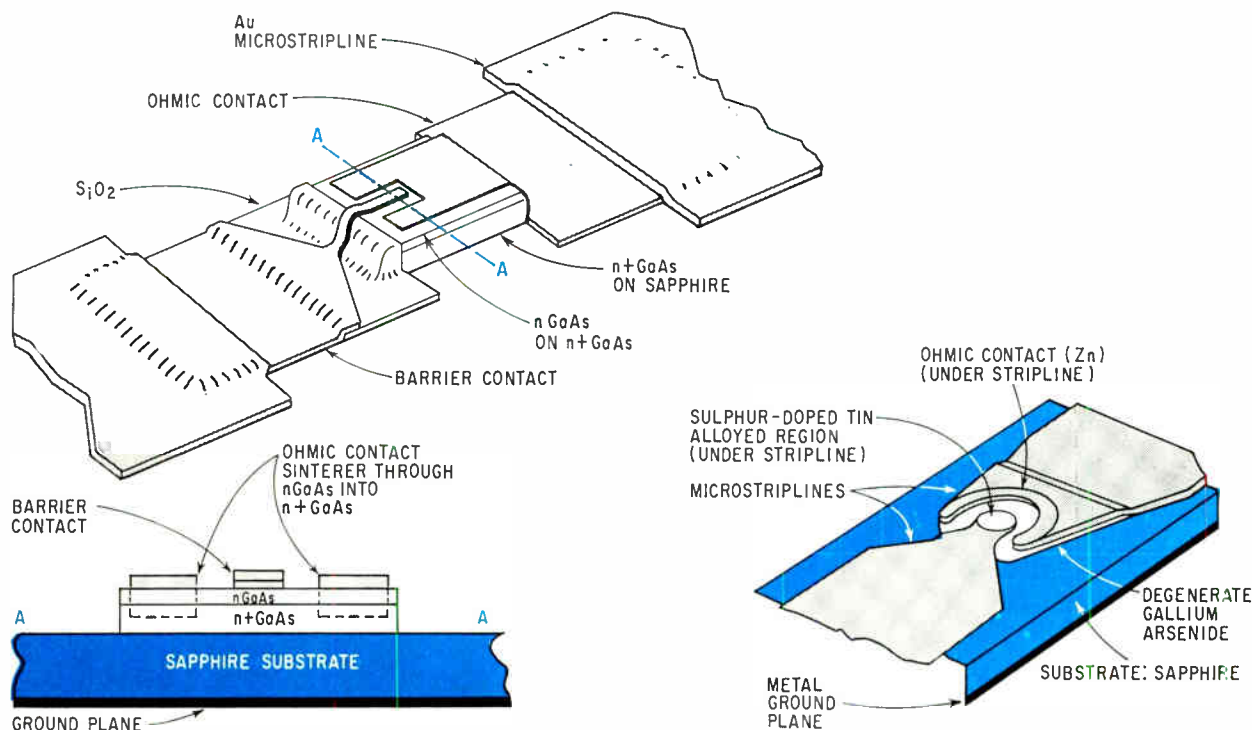

that this points to mixer-diode cut-off frequencies in GaAs greater than in SOS devices (100 Ghz against about 50 Ghz).

The tunnel-diode effort is headed by Richard Palmquist, who says the main advantage over the usual hybrid fabrication techniques is similar to that of the mixer diode—the devices can be made in monolithic microwave stripline arrays. In addition, peak-to-valley current ratios as great as 20:1 and typically 10:1 are possible for the first time in GaAs on sapphire. Also, the process produces vertical junctions instead of the more fragile horizontal junctions associated with hybrid microstripline tunnel diodes.

Vertical junctions are formed when the metal "dot" alloys sulphur-doped tin through to the GaAs-sapphire interface in a cylindrical fashion. As a result tunneling takes place around the circumference of this cylindrical junction, not just at the base as in horizontal-junction tunnel diodes.

In both the mixer-diode and tunnel-diode work, Autonetics officials say, the monolithic approach leads

to better reproducibility. Higher packing density should also be possible because of the electrical isolation of individual devices on an insulating substrate, which should minimize stray capacitances.

New materials. Ruth believes that the GaAs-on-sapphire work at Autonetics—a division of the North American Rockwell Corp.—is more advanced than the firm's SOS effort was after the same amount of development work, and that the sophistication is attributable to the new vapor-deposition process. The process involves the reaction in a hydrogen atmosphere between a Group III organometallic compound (trimethylgallium or triethylgallium) and a hydride from Group V—arsine, phosphine, or arsine-phosphine mixtures, depending on the semiconductor compound desired. Roth says that the company-sponsored work represents the first practical use of this new class of reaction.

Its advantages over other chemical vapor-deposition epitaxial GaAs growth processes are that it requires only one temperature zone, compared with two carefully con-

trolled zones for established methods; the atmosphere is probably free of etchants, minimizing out-doping and other kinds of substrate contamination; the technique can be used for simultaneous epitaxial growth on both semiconductor and insulator substrates; doped or undoped growth is accomplished at lower temperatures (600° to 825°C) than those used in other kinds of reactions, and the process is simple, flexible, and compatible with methods now used to grow epitaxial layers of elemental semiconductors.

Autonetics chose sapphire substrates initially, mainly because of the division's SOS experience, but officials in the physical sciences department believe beryllium oxide has even greater potential. Its thermal conductivity at room temperature is seven times that of sapphire, promising devices with more power than those with sapphire substrates.

Spinel's chief attraction is that its cubic crystal structure is better matched to the structure of GaAs and silicon semiconductor materials than are sapphire or beryllium oxide. Ruth says this should contribute to a lower defect density in the semiconductor layer.

Companies

Parent and child

A man who had dinner with Robert N. Noyce a couple of months ago came away from that meeting, he recalls, with the distinct impression "that Noyce was making up his mind whether or not to grab for the big brass ring." The big brass ring is the presidency of the Fairchild Camera & Instrument Corp. Noyce was then sharing the duties of that office with Sherman N. Fairchild and two of his financial advisers after Fairchild had ousted two previous chief executives in five months.

Almost everyone who knew Noyce said that he wouldn't want the top job because he was too nice; he wouldn't want to be the



Ring up a computer. Engineers at Bell Telephone Laboratories in an in-house experiment, linked an unmodified commercial computer to this Picturephone so their device could be used as a desk terminal to display data on such things as inventories and news, stock, and weather. Bell plans additional tests; no marketing plans have been made.

kind of head-knocker that a corporation president has to be. On the other hand, they felt that he might take the job anyway, to influence further the growth of Fairchild Semiconductor, whose chief founder he was and whose fortunes had been so bound up in his own.

Problem solved. Noyce apparently decided that the corporate position wasn't worth the sacrifice, and in any case the corporation was skeptical of his business experience; Fairchild was making informal feelers for a new chief executive, and in June reportedly made at least one formal offer, which was declined.

If Noyce was not to be president, his role in the corporation and in the division was cloudy. At a directors' meeting late last month, Noyce solved his problem by resigning from both operations—thus leaving the parent company without any operating executive for the moment. Simultaneously, Gordon E. Moore, a cofounder of Fairchild Semiconductor and now its research and development chief, announced that he, too, was leaving. Moore had decided to quit two weeks previously, but colleagues at Semiconductor had been trying to persuade him to change his mind with the argument that Noyce, as heir presumptive to the presidency, would protect Moore from the attentions of corporate headquarters.

Double challenge. Whoever the new president of Fairchild is, he will have to shape a new position for Fairchild Semiconductor both within the parent corporation and in the semiconductor industry.

Fairchild Semiconductor was founded by eight scientists, and has maintained a reputation as a technological leader. The technology has produced profits—to such an extent that the logistics of production and activities at the New York Stock Exchange are now more important to the division than the future of gallium arsenide. The departure of Noyce spotlights what has been a reality for some time: technology, Fairchild's strength, is a tool of the corporation, not a goal in itself.

Except for the fact that its role

Shock cart.

Stanford University's School of Medicine has developed a mobile console that monitors persons in shock. The system, being built by Honeywell's Test Instruments division, Denver, simultaneously takes electrocardiograms and measures blood flow, intravascular blood pressure, and other parameters associated with shock. The cart also has a retractable mounting arm for positioning the transducers near the patient, a multi-channel oscillograph for immediate and permanent recording of the physiological information.

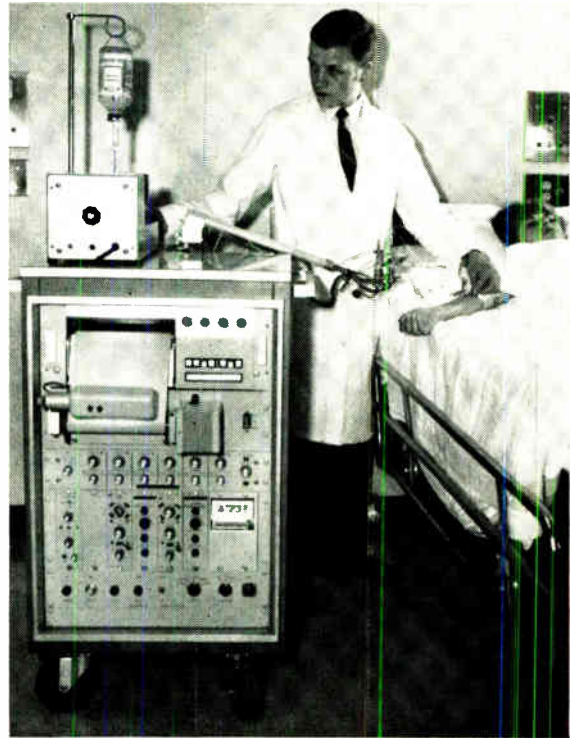

has been entirely benevolent, the Semiconductor division has been like the camel in the tent for Fairchild Camera & Instrument. Founded in 1957 by Noyce, Moore, and six other refugees from Shockley Laboratories Inc., the semiconductor division has been profitable almost from the start. And last year its sales accounted for well over half of Fairchild's total revenue of \$209 million. (Insiders say that "well over half" is a corporate euphemism for about two-thirds.)

Moreover, only three of Fairchild's eight divisions were profitable last year, and the pressure on the Semiconductor division to produce profits for the rest of the corporation has been a source of continuing tension between the unit's Mountain View, Calif., headquarters and the corporate offices in Syosset, N.Y. Fairchild Semiconductor's target is pretax earnings totaling 20% of sales.

Resistance. But with prices of linear integrated circuits falling rapidly, fierce competition in digital circuits, and a buyers' market in discrete components, the division tends to resist corporate pressure. This pressure manifests itself as a stream of questions from

the corporate level about day-to-day operations, such as why a certain R&D program is being carried out, or why a given section has a particular number of employees. The corporation has never tried to cut down on research and development, but it has tried to get outsiders to pay for it. The division has traditionally shied away from Government-sponsored R&D, though, and has successfully resisted the pressure from above.

Richard Hodgson, who took over as president of Fairchild last November when it was already apparent that the corporation was heading for a bad year, did what he could to relieve the pressure by dealing off the money-losing Davidson division and the memory products and oscilloscope operations, and writing off tremendous amounts of inventory and obsolete equipment. But Hodgson apparently moved too fast for board members Walter Burke, Sherman Fairchild's financial adviser, and Joseph B. Wharton, an investment counselor, who were worried by Fairchild's erratic performance on the stock market. Hodgson was elevated to vice chairman of the board in April.

In contrast to Hodgson's performance, Noyce's two-month stint as a director (with Fairchild, Burke, and Wharton looking over his shoulder), has been a quiet one.

There are still reports that Fairchild will sell off the unprofitable Space and Defense Systems division, but no steps have been taken yet. One other possibility is that Fairchild will recognize the importance of the Semiconductor division by splitting the corporation into two separate entities, one comprising the Semiconductor and Instrumentation divisions and the other the rest of the firm.

Too big. That would give what many consider the proper importance to the Semiconductor division. But with Noyce gone, Syosset is clearly in control.

Of the eight Semiconductor founders, only one, Julius Blank, is now active in the corporation (though another, Victor Grinich, is on leave of absence). All are wealthy, but, in a way, the founders have been engulfed by success. They have become involved in big business without realizing it. Moore now wants to start afresh with his own company, though at present his plans aren't far advanced. Noyce, too, said on resigning that he would like to

establish an association with a small company trying to develop some new product or technology.

It seems that no one wanted to become really big. "As recently as a couple of years ago," said one friend after the resignation was announced, "you might call Noyce's home and they'd tell you, 'Bob's gone over to the lab,' because that's how they felt about Fairchild Semiconductor."

Consumer electronics

Some push tubes . . .

Despite the trend to replace all television tubes with semiconductors, at least two electronics companies are bucking the tide. The tube divisions of RCA and General Electric are trying to stave off the day of tubeless tv by developing better and better tubes and novel ways to use them.

RCA, for example, is offering a family of nine-pin miniature tubes that can be used in a vertical deflection circuit to enable adjustment of the picture height control with little or no interaction between the height and linearity con-

trols. The tube is a member of the new 6JQ6 family.

Model set. GE's tube division in Owensboro, Ky., has gone farther by designing a color tv set. It's being shown to tv set makers as an example of how to build a 10-inch color set to sell for under \$150. The GE design, called 8+1 (for eight multifunction Compactron tubes plus one Compactron high-voltage rectifier tube) uses the nine tubes at a total tube cost of under \$8. The 8+1 is a follow-on to last year's highly touted, though markedly unsuccessful, 4+1, which was intended for black-and-white sets.

In the 8+1 design the signal channel uses a double pentode Compactron that provides two stages of i-f amplification and a pentode video amplifier that shares its envelope with the chroma amplifier. The i-f circuit is of the conventional variety and includes traps for the 41.25- and 47.25-megahertz signals.

The audio and sync are picked off from the second i-f stage, then amplified in one of two triode sections of the Compactron, which provides automatic gain control keying and horizontal feedback. This signal amplifier feeds the agc keyer, audio detector, and sync clipper circuits. The color burst is gated to the 3.58-Mhz color subcarrier by the horizontal retrace pulse. The color signal is demodulated by a low-level diode demodulator and matrixed in the color difference amplifiers.

However, the deflection circuits represent the most important development of the 8+1 color set. For example, the horizontal deflection circuit, which develops the 18,000 volts for the picture tube, is of the self-oscillating type, and is synchronized by the incoming horizontal sync pulses. Therefore, no afc circuit is provided. This is essentially the same circuit that GE had used in the abandoned 4+1.

Yoke driver. The vertical deflection circuit is being used for the first time. Its principal advantage is that it can drive the deflection yoke directly without the use of a matching transformer. To simplify convergence, the 8+1 uses

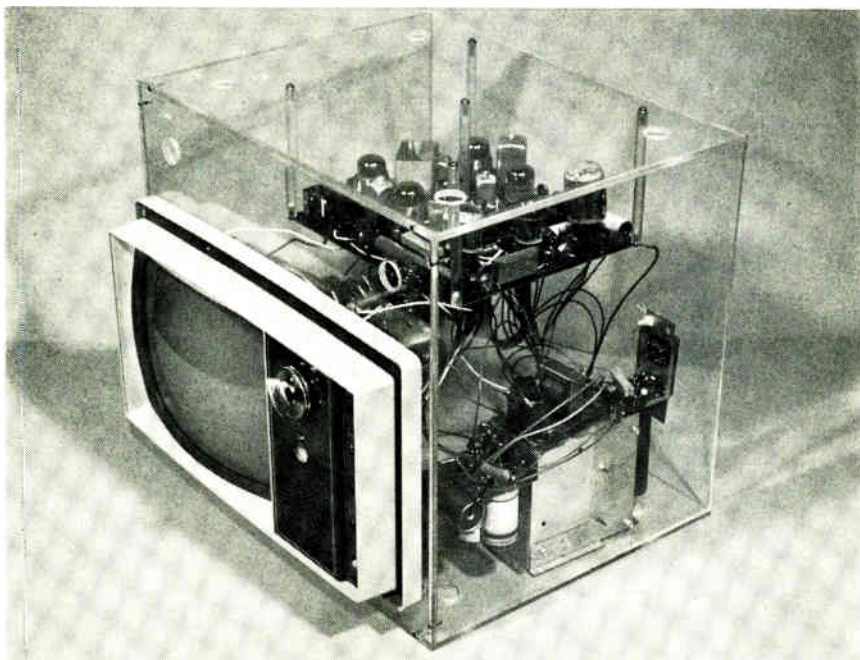

Tube tv. General Electric is trying to convince television makers to design color receivers with its Compactron tubes.



EASIER TO READ

WITH

POLAROID CIRCULAR POLARIZERS

Look what happened to the readability when we took the filter away from the top half of our readout.

A 25% transmission neutral density filter would improve the readability by about 4 times.

But the Polaroid Circular Polarizer at the bottom of our readout improves unfiltered readability by about 110 times. Because it polarizes the light that others only filter.

If you're designing a display, and you'd like a sample for testing, write Polaroid Corp., Polarizer Sales, Dept. 76, Cambridge, Mass. 02139.

Then you can prove that no matter how bright room lighting conditions may be, your readout will stand out.

And, after all, isn't that the whole idea?

a picture tube that has in-line guns.

Some corners had to be cut to keep the price of the 8+1 down. One concession was the use of hot chassis construction with a 600-milliamperere heater string, a design generally found in low-price sets.

. . . others go solid

Meanwhile, component producers are still pushing for tubeless tv sets.

First Amperex introduced its A705 high-voltage horizontal output transistor [Electronics, Oct. 16, 1967, p. 46]; then Varo entered the race with the first solid state high-voltage rectifier [Electronics, March 4, p. 42], just when Amperex' solid state rectifier project ran into difficulties and had to be shelved, at least temporarily. Now Delco Radio is ready to take on Amperex with its new DTS-0713E transistor for the horizontal-deflection circuit for color sets, and the DRS-112 damper diode.

Across the ocean, ITT's European subsidiary, Standard Elektrik Lorenz AG of Germany, is trying to hop aboard with a line of high-voltage selenium rectifiers that include a miniature cartridge type that can be used in a multiplier arrangement to achieve the required high-voltage rating for color sets.

Motorola is already using the Varo device in its 1969 color line. However, the sales leader in the color tv market, RCA, is holding back. Its latest designs are all solid state except for the high-voltage rectifier. Explains Wayne W. Evans of RCA's color-tv engineering staff: "We have sampled a number of devices, but we've found tubes to be more reliable than the devices that we have experimented with so far."

Varo's Jan Collmer counters with: "It's more a matter of economics than reliability—tubes are still cheaper. We have devices that are rated at 45,000 volts, peak inverse voltage, and that is clearly better than any kind of tube can take."

IC's in tv's

Despite all the ballyhoo, integrated circuits have made very little headway in television sets. IC's are being used only in the audio section and automatic fine-tuning circuits of some top-of-the-line color sets. The only reason set makers advance for this slow pace is that IC's still cost more than discrete

—and soon.

At least four microcircuit producers—Sprague Electric, Motorola, General Instrument, and Fairchild Semiconductor—have developed IC chroma demodulators for color sets. And General Instrument says it will soon be offering monolithic circuits for all the color-processing functions: chroma burst separation, color killing, color matrix, and color sync.

Recover color. Sprague's devices, ULX-2114K, uses two balanced quadrature detectors that operate simultaneously to recover the blue and red information from the 3.58-megahertz chroma subcarrier.

Motorola's circuit, the XC1325P, uses differential amplifiers instead. The reference signal is applied differentially between base terminals of the two amplifier pairs, while the signal to be demodulated is applied through current amplifiers.

The Fairchild circuit, μ A737E, uses a quadrature amplifier arrangement somewhat similar to the Motorola circuit. In this setup, the B—Y and R—Y color-difference voltages are developed across collector loads and added to the collector currents to produce the G—Y signal.

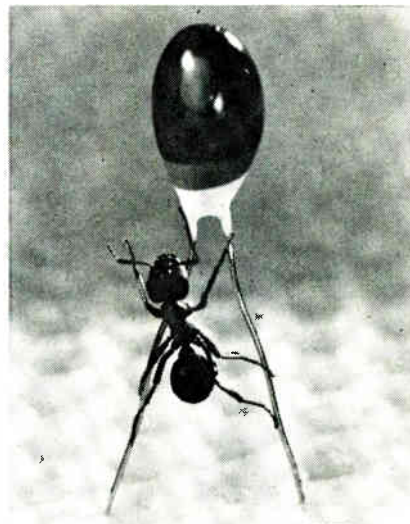

Solid state. ITT's selenium high-voltage rectifier . . .

components. But with IC prices generally going down as volume picks up, most set makers at last month's IEEE Spring Conference on Broadcast and Television Receivers in Chicago conceded that they will be using IC's extensively



. . . stacked to provide wide variety of voltages.

Manufacturing

Cool stripper

At least one semiconductor manufacturer, the Signetics Corp., is using radio-frequency-induced plasmas instead of acids to remove photoresist from silicon wafers. And the technique can also be used in the laying down of silicon-dioxide and silicon-nitride passivation layers, doing the job at relatively low temperatures and thereby greatly simplifying the process.

Steve Irving, a materials scientist at Signetics, is credited with the first application of electrodeless, r-f-induced atomic oxygen plasma—low-temperature ashing—to the semiconductor field. Asked to find some way of removing

No other 100W silicon power transistor in the industry can match this performance point

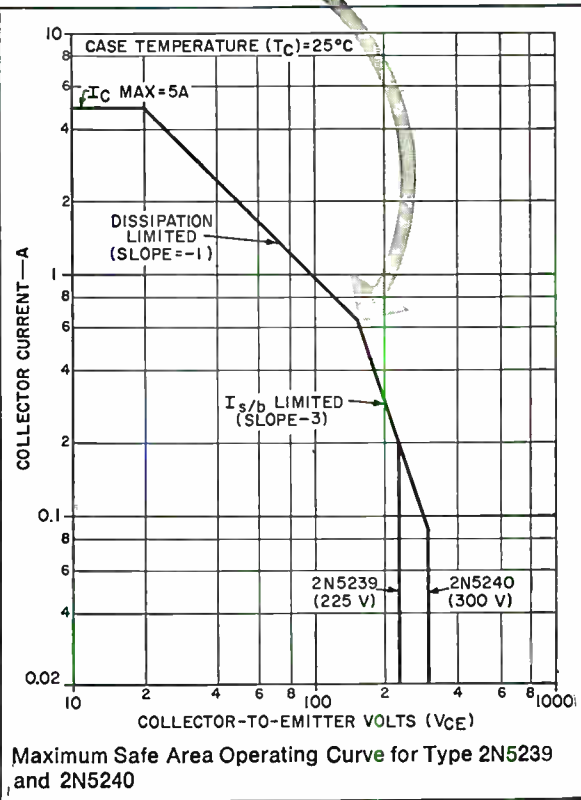
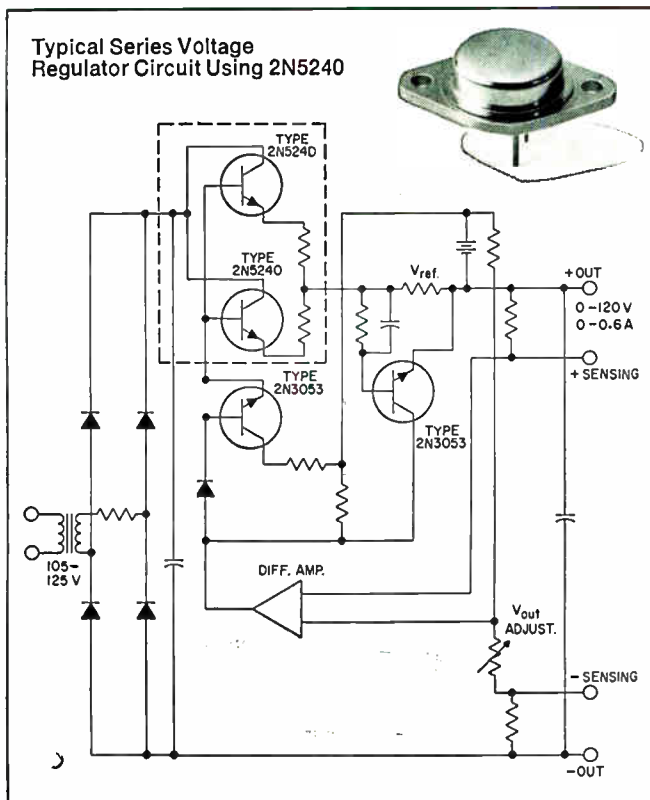

Now, full second breakdown protection up to 100 W dissipation and 150 volts, plus safe area rated up to 300 volts! That's a brand new level of power performance and reliability for high-voltage silicon transistors.

We made this capability possible by creating a unique pellet construction technique—multiple diffusion combined with the multiple emitter concept made famous by RCA "overlay." To you, this means better performing, more reliable circuits for high-voltage regulators, series regulators, high-speed inverters for off-the-line operation, switching bridge amplifiers for servo motor controls, and ultrasonic power amplifiers.

Depending on your circuit requirements, you can choose between the 2N5240 with a V_{ce} (sus) of 350 volts or the 2N5239 with a 250 volt rating. Both transistors have an I_c (max.) of 5A and P_t of 100 W.

For more information consult your RCA Representative or your RCA Distributor. For technical data, write: Commercial Engineering, RCA Electronic Components and Devices, Section IN7-1, Harrison, N. J. 07029.

RCA

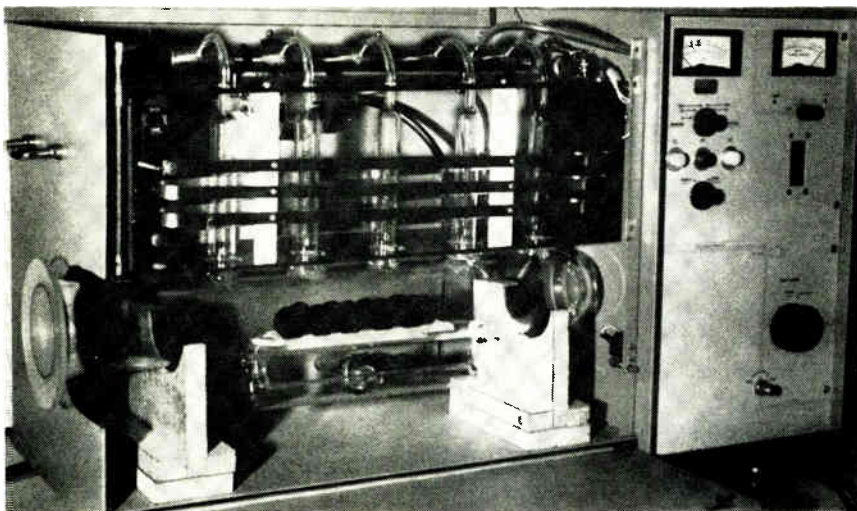

Etch it. R-f-induced plasma, rather than acids, removes photoresist from silicon wafers in new Signetics operation.

photoresist, the highly toxic chromic and sulphuric acid mixtures sometimes left on wafers, Irving found that he could do away with the acids entirely.

College memories. "Photoresist material," he explains, "is nothing but organic material, and I had remembered from college that when we were looking at trace elements in diseased human tissue, we had had the same problem of removing the organics without volatilizing the elements we wanted to look at." If low-temperature, r-f-induced oxygen plasmas could handle this job, he reasoned, why couldn't they volatilize organic materials without altering the crystal structure of nonpolymers on a wafer?

Experiments performed by Signetics a year ago showed that low-temperature ashing could completely strip photoresist material without degrading the wafer in any way. Although the company won't say what percentage of its production volume this technique is now being applied to, spokesmen have indicated that the use of strong oxidizing agents is on the way out.

Supplier. And according to Richard L. Bersin, president of the newly formed International Plasma Corp. in Hayward, Calif., the same technology can be used in the process of laying down the five to six passivating layers required for complex semiconductor wafers.

Equipment being built by International Plasma will strip 100 wafers covered by 5,000 angstroms of polymer photoresist in less than five minutes. In the process, a 5-torr plasma is initiated in one or more chambers by applying an r-f voltage to externally mounted electrodes. Highly reactive atomic and ionic oxygen created in the plasma decomposes and removes the photoresist compound by forming volatile reaction products that are immediately pumped away. The operation is generally performed at around 100°C in an atmosphere of 20% atomic oxygen.

With the same equipment, but at 500°C, a plasma of either atomic oxygen or atomic nitrogen will lay down a passivating layer, the thickness of which is a function of time of exposure, pressure, gas flow rate, and r-f power.

Independent steps. Because it's performed at a temperature about half that needed for conventional thermal oxidation, this operation doesn't generate the diffusion of silicon dopants typical of oxidation. And because there's no need to make allowances for these dopants, each layer of passivation can be applied independently of the others.

The equipment, due to be marketed by International Plasma next month, will operate at 13.5 megahertz at up to 1,000 watts. The machines, which will sell, accord-

ing to Bersin, for under \$10,000, contain only four plug-in circuit boards and 12 test terminals; a common voltmeter set to the 10-volt range can be used to test all voltages. Bersin notes that repairs can be made simply by correlating an incorrect voltage with a defective circuit and then replacing that circuit.

Commercial electronics

Fare price

The simplest system of all was a hands-down winner of the automatic fare-collection contract let by the San Francisco Bay Area Rapid Transit District (BART) late last month. IBM, a surprise entry, was so far under the competition with its bid of \$4.9 million that there was really no contest at all.

The IBM system, which will automatically deduct fares from a magnetically coded card, uses no external computer, only a memory and logic system inside the ticket reader.

Three types of systems were tested by BART. The FMC Corp. and Control Data, which jointly developed a system using a huge central computer, didn't even bother to bid. The Advanced Data Systems division of Litton Industries, whose system used a computer in each BART station, though not in each gate, entered a bid of about \$20 million. General Electric, whose system is also simple, was still far above IBM at about \$9 million.

Open-door policy. The district had expected to spend \$6.8 million to \$9.8 million for the system. It was so delighted at the IBM price that it picked the most expensive option, one calling for a normally open gate (instead of one that closes after each passenger goes through), plus two years of maintenance. The open gates, which will close if any passenger doesn't pay his fare, permit greater traffic loads in peak hours.

The system, developed in IBM's

POWER WITHOUT PERIL for Analog Equipment

New Philbrick/Nexus current booster and voltage regulator modules fully protect op amp circuits against overloading

Whether your analog circuits require high load power, high stability or a high degree of regulation, Philbrick/Nexus power products have exactly what you need. Philbrick/Nexus helps you shrink op amp circuits by supplying compact, fully encapsulated, *completely overload protected* booster amplifiers and voltage regulators.

Model 2001 Current Booster provides ± 500 mA at ± 10 volts with wide frequency response. A slewing rate of 10 volts/ μ sec. offers full output response to 80 KHz. Voltage gain approaches unity with current gain greater than 40,000 times. Phase shift is less than 10° at 10 mHz.

Model 2101 Dual Voltage Regulator delivers ± 100 mA at ± 15 volts. Accepts input range from 19 to 40 volts. Unit offers high regulation (.01%). Low ripple and noise. Operates over a range of -55°C to $+85^\circ\text{C}$ at 50 ppm.

A dual output regulated power supply, Model NPS-300 is also available from Philbrick/Nexus. It features separate positive and negative outputs with individual adjustments to any output between 12 and 18 volts at any load between zero and 300 mA each. Model NPS-300 is short circuit proof. Price: \$135.

Call your Philbrick/Nexus sales representative for complete specifications, prices and applications assistance. Or write, Philbrick/Nexus Research, 22 Allied Drive at Route 128, Dedham, Massachusetts 02026.

Philbrick/Nexus invites technical employment inquiries



PHILBRICK/NEXUS RESEARCH

A TELEDYNE COMPANY

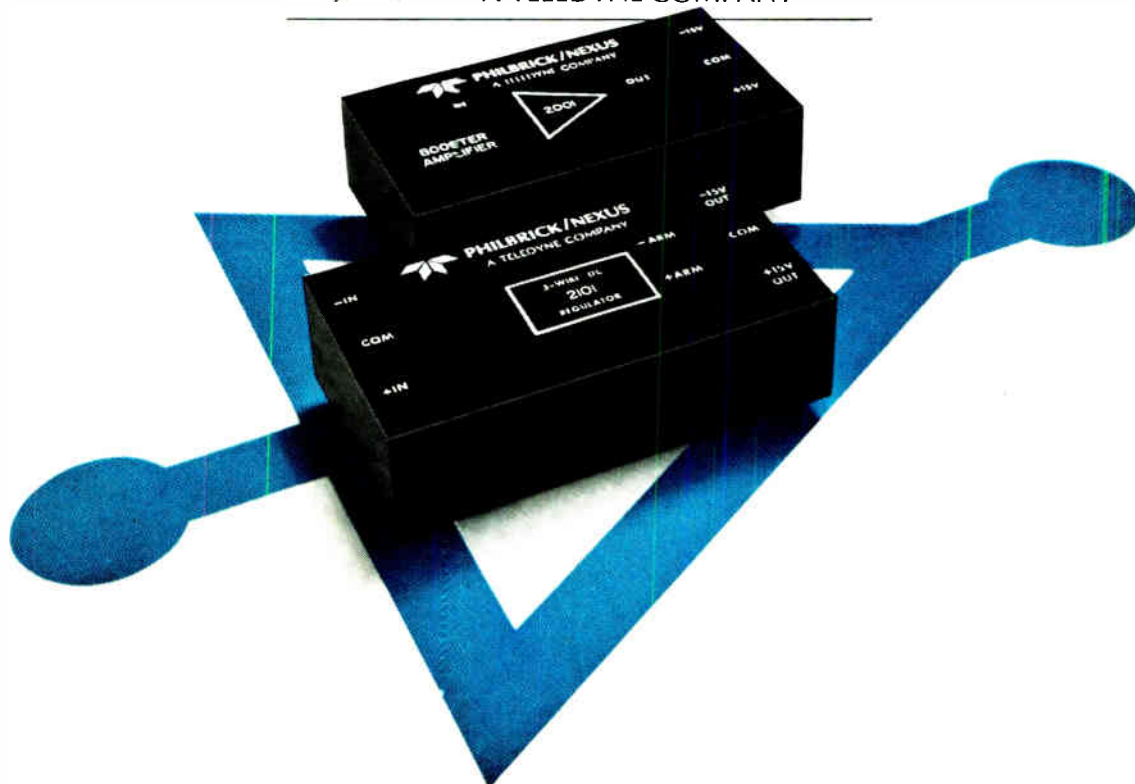

Los Gatos, Calif., advanced development facility, will be made by the Federal Systems division in the same Huntsville, Ala., plant where Apollo-Saturn launch vehicle instrumentation is built. IBM will deliver 236 gates, 96 ticket-reading machines, 47 add-fare machines—for persons whose magnetic cards don't have enough left on them for the full fare—119 money changers, and 44 special ticket readers for station agents, to detect faults in magnetic coding.

Like the other systems, IBM's requires a passenger to insert his ticket into a reader on entering the station and again on reaching his destination. The second reader automatically deducts the fare, and prints out a notification of the amount remaining on the card. IBM's way of doing this, which reportedly capitalizes on existing components in IBM computers, has implications for airline quick-ticketing systems.

The district also awarded a \$1-629,000 contract to the WDL division of Philco-Ford Corp. for yard control and communications

systems. Philco beat out six other bidders, including Western Electric, contractor for the main train control and communications system.

Philco will build a command and control system that will take care of the trains when they aren't in service. Sensors will read serial numbers as cars enter the yard, and the central console will direct them to repair shops, storage areas, and washing facilities. The bid was another bargain; the district had estimated the cost at \$2.9 million.

Military electronics

Plastic's progress

Plastic-encapsulated integrated circuits have been around for several years but have yet to receive the blessings of the Pentagon or NASA. Now the Government has indicated its willingness to give plastics a hard look and has set up an organization to test them.

Late last month representatives of the Army, Air Force, Navy, and NASA met in Washington and established three groups that will make or break the devices for Government service. They are a working group for test methods and procedures, a unit on research and development, and a management policy group.

Sticky problems. The test methods group will examine the most critical aspects of the acceptance problem. It plans to tackle such issues as perfecting test and evaluation procedures; determining differences between plastic and hermetically sealed devices; setting up standards for temperature and humidity tests; and considering changes to be made in published standards and testing publications (such as military standard 750 and 883) and the costs and tradeoffs involved in screening plastic devices.

The group will be struggling with two sticky problems that came up at a May triservice-NASA meeting on plastic IC's [Electronics, May 27, p. 25]. It was determined at that meeting that there is no consensus among users, potential users, and manufacturers on the reliability of plastic semiconductor devices.

It was also agreed that there has been no good determination of the costs of screening. Some delegates even brought up the possibility that plastics might cost more than metal cans because of the extensive screening that may be necessary before they can go into military and space systems.

Government

That's a switch

An economist testifying before the Senate antitrust subcommittee has challenged the very premise of the panel's investigation of defense contracting practices. The Senators, exploring charges that the Pentagon wastes public funds by

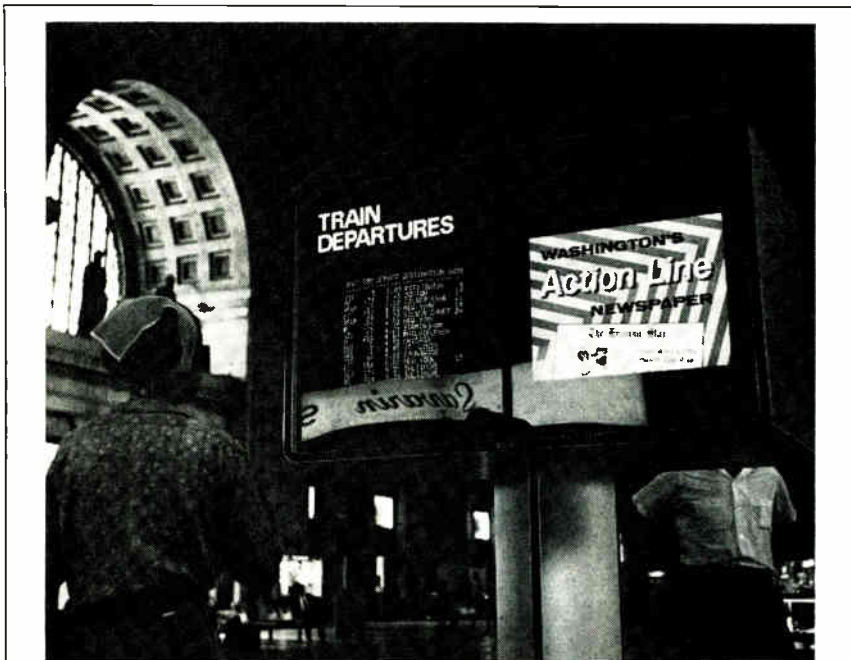

On display. The A.B. Dick Co. has long been known for its duplicating and copying machines. But now, as a result of spin-off from its electrostatic high-speed label-printing equipment, the firm has entered the electronic data-display field with this unit, the Videograph Series 900. It can present up to 512 characters in 16 rows directly from a keyboard or a computer. This installation is at Penn Central Station in Washington.

E-H 128 \$980 Don't tell our new Model 128 it has a low price tag. Actually, the E-H 128 thinks, acts and talks like a much higher-priced box — gives you features never offered in a general purpose pulser at this price.

For instance? Risetime of $< 3.5\text{ns}$ and $< 4\text{ns}$ fall-time; rep rate to 50 MHz; dual outputs (positive and negative), 5v amplitude; independently controlled and continuously variable, attenuation ranges of 1,

2, 4, 8, 16; single and double pulses; single cycle pulses; external driving and external gating. All this and continuously variable trigger width (10ns to 50ns), plus pulse width and pulse delay continuously variable from 10ns to 10 milliseconds. What it adds up to, of course, is a pulser which gives you more discrete measurements and wider breadth of measurement than many pulsers costing hundreds of dollars more. Worth looking into.



E-H RESEARCH LABORATORIES, INC.

163 Adeline Street • Oakland, California 94607 • (415) 834-3030 • TWX 910-366-7258
In Europe: E H Research Laboratories (Ned) N.V., Box 101E, Eindhoven The Netherlands, Telex 5111E
In Japan: Iwatsu Electric Co., Ltd., No. 710, 2-Chome Kugayama Suginami-Ku, Tokyo, Japan

often ignoring competitive bidding, heard Frederic M. Scherer of the University of Michigan assert that there's already too much rivalry for orders and that the situation is squandering both money and engineering talent.

Scherer, a specialist in military spending, stressed that price cannot be the sole criterion in defense contracting. "What often counts more—and properly so—is technical performance, operational reliability, and speed of delivery," he declared.

Short list. About half the \$40 billion spent each year on the military procurement is awarded non-competitively. And almost half the Pentagon's prime contracts go to just 25 companies.

But Scherer would like to see the competition further limited. He told the subcommittee that whether the emphasis is on technical competence or price, contractors now enter "one competition after another until enough successes have been scored to ensure a full order book." This activity, he continued, "is a voracious consumer of the contractors' creative talent. The best scientists and engineers in industry . . . spend a large part of their time working on proposals and relatively little on the actual implementation of contracts won."

Scherer noted that the Government has a difficult time choosing among technical proposals because of the uncertainties that blur the figure of any advanced weapon and because contractors tend to view any task through "rose-colored glasses." Consequently, it has moved away from making judgments solely on the basis of specific designs and is putting increasing emphasis on companies' total technical and managerial capabilities, widening the competition.

This trend has led, according to Scherer, to a "hoarding of talent and facilities by defense contractors that probably represents a waste of billions of dollars annually." The Government, he contended, "gains little, and in all probability encourages the waste of valuable resources, when it invites more than three to five care-

fully chosen companies to submit technical proposals for a new program."

Confrontation. The Senators were further told that "implicit and explicit pressure from Congress to present at least the appearance of vigorous and impartial competition contributes to excessively widespread dissemination of invitations to bid." The Pentagon has to indulge in this "window dressing" and wade through a great deal of "talent-wasting brochuremanship" by contractors for the sake of appearances, Scherer said.

The economist suggested that the Pentagon put more emphasis on past performance in choosing contractors. He said the Defense Department is moving in this direction, "although not very vigorously."

Scherer proyed to be less sanguine than the Pentagon about the benefits of incentive contracts. He conceded that they spur some added efficiency, "but profits under incentive contracts depend not only upon skill in cost reduction, but also upon skill in bargaining for the initial cost targets and for making changes in the targets as design modifications are authorized in midstream."

Scherer concluded his testimony on a note of irony. He suggested to the panel that waste and inefficiency in the awarding of military and space contracts might not be so bad after all. About the only "unambiguous braking force" on the rising economic burden of armaments, he said, is the high cost of weapons; higher efficiency and lower costs in weapons development could thus lead to bigger arms inventories and a heavier over-all financial burden in the long run.

On the other hand

At just about the same time that Senate hearings opened on military procurement policies, the Pentagon was making an award that showed how competition can cut prices.

The contract went to the Elec-

troospace Corp. of Glen Cove, N.Y., and covered a \$2,260,476 first increment of a \$19,261,841 four-year purchase of AN/PRC-77 manpack radio transceivers and RT-841 transmitters. Electroospace, which was identified in the brief Pentagon contract announcement as "a small business firm," submitted the lowest of 21 bids for the orders.

Quick whistle. The radios were developed by RCA in 1966 at a cost to the Defense Department of \$694,000. The Army then awarded RCA two production contracts. The first, in 1966, stipulated a unit price on the sets of \$1,222. In the second contract, let last year, the price was \$937. Sen. Peter Dominick (R., Colo.) got wind of the affair and blew the whistle in May [Electronics, May 27, p. 73]. He noted that though the initial contract included \$54,834 to pay for manufacturing drawings, the Army had justified the award of the second order to RCA on the basis of "urgency of delivery and lack of manufacturing drawings."

As a result of Dominick's investigating, the Army did an about-face and put the radios up for bidding. Electroospace's proposal came to about \$480 per unit; RCA's bid, at about \$610 a unit, was about the tenth lowest even though the company has had previous production experience.

Dominick estimates that the Pentagon will save as much as \$15 million because it went to competitive bidding instead of continuing to award the contract noncompetitively to RCA.

Management

Life or death

A year ago, when Charles S. Rockwell took over as vice president and general manager of ailing Sperry Gyroscope, his orders were simple: cure it or kill it. Now Rockwell, after laying off 450 production workers, believes the prognosis is encouraging.

Rockwell has used two kinds of

Looking for Fast, High Volume AC and DC Calibration Capability?

Whenever and wherever you need precision, high volume calibration capability for your calibration laboratory, production line, maintenance testing shop — Hewlett-Packard has an instrument that specifically meets your requirements.

Two of these instruments—designed specifically to meet high accuracy and high volume calibration needs—are the hp 740B for DC and the hp 745A for AC. With either instrument, you press a button, turn a dial and you have an instant voltage reference!

High Resolution DC Calibration. The hp 740B DC Standard/Differential Voltmeter delivers output voltage to 1000 V with six digit resolution in discrete steps of 1 ppm of range. Accuracy of $\pm(0.002\%$ of setting $+0.0004\%$ of range) extends over 30 days.

As a differential voltmeter, the 740B measures voltage to 1000 Vdc with an input resistance of $>10^{10}\Omega$, independent of null condition. Accuracy is $\pm(0.005\%$ of reading $+0.0004\%$ of range $+1\mu\text{V}$).

The 740B is also a precision dc amplifier and high impedance voltmeter, and can be used to drive a recorder.

Fast, Accurate AC Calibration—Cut your ac calibration time in half with the state-of-the-art hp 745A AC Calibrator—an excellent choice for pro-

duction line calibration and maintenance testing.

The 745A has a calibrated output voltage with $\pm 0.02\%$ accuracy. It also has a six-digit readout, pushbutton ranging and a continuously adjustable frequency from 10 Hz to 110 kHz.

Eliminate tedious error calculations with the exclusive 745A direct reading percent error scale.

Get full specifications on these and other calibration instruments from your hp field engineer. Or, write to Hewlett-Packard, Palo Alto, California 94304. Europe: 54 Route des Acacias, Geneva. Price, 740B, \$2350; 745A, \$4500.

098/18

HEWLETT  PACKARD
WORKING STANDARDS



Circle 63 on reader service card



**"Bulldog"
Marshall spends
another
disappointing day
with Super-Mercury.**

Marshall? He's the crankiest of the Twelve Cranks on Pleasant Avenue. One of the extra-picky grumps at Trygon Power Supplies who feels good all over only when he can pick something off our production line and shriek, "Hey! This is no % #&ç@# good!"

So far, he's had problems with our Super-Mercury series. Because there haven't been any problems.

The Super-Mercury is a brand new competitively priced series, the new generation of the industry-accepted, field-proven Trygon Mercury Series: fully programmable wide-range power supplies, power and value packed, offering precision Constant Voltage/Constant Current operation. Precision performance (with up to 2000 watts output), in ranges up to 160 volts and up to 100 amps. .005% regulation and 0.015% stability are standard (.005% stability optional) as is MIL Spec, RF-free performance. Total ripple and noise less than 1mv rms and 10MV P-P (to 10MHz). Master-slave tracking, auto-load share paralleling and remote sensing and programming are also standard with Trygon's patented tracking overvoltage protection available.

Marshall and his friends check the dozens of Super-Mercury features that make this series a Super-buy for you. Now it's your turn to check on them. Order a Super-Mercury as a starter.

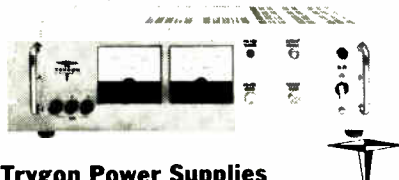

Trygon Power Supplies
111 Pleasant Avenue, Roosevelt, L.I., N.Y. 11575
Trygon GmbH 8 Munchen 60, Haidelweg 20, Germany

radical surgery. First, he has shied away from risky contracts, reducing business but increasing profit margins. Second, he has "consolidated facilities" by the layoffs and by closing sections of the huge plant at Lake Success on Long Island, N.Y. The latest layoff, for example, will leave only half of the building's 2.4 million square feet in use.

Still breathing. All this has led to persistent reports that the plant is being phased out. Sperry spokesmen are equally persistent in their denials. "That," says one, "is just what we're trying to avoid."

Work is going on at Lake Success on five projects—modernization of the Terrier missile's fire-control system, the prototype of an advanced destroyer sonar system, the guidance unit for the Spartan missile (part of the Sentinel antimissile system), inertial navigators for attack submarines and aircraft carriers, and electronically scanned phased-array radars.

Communications

Bridging the gap

The second phase of the Defense Satellite Communications System (DSCS-2), which has just gotten a formal Pentagon go-ahead, will blur the boundary between the long-haul strategic relay craft the program will produce and the experimental tactical communications satellite being built by Hughes Aircraft for the three services.

The missions differ, of course, and the Tacsat will transmit at ultrahigh as well as super-high frequencies, but otherwise the craft will be markedly similar. Both will employ narrow-beam steerable antennas. The DSCS-2 will also have the earth-coverage antennas carried by satellites in the first-phase system, but it will work with smaller ground terminals—stations similar in size to those specified for Tacsat. Like Tacsat, the station-keeping DSCS-2's will be placed in stationary orbit; the first-phase satellites drift in a near-syn-

chronous orbit about 21,000 miles out.

One design? The Defense Communications Agency (DCA), sponsor of the DSCS program, is already planning for a third-phase system that would be operational around 1975. Bound to be more technologically advanced than its predecessors, the DSCS-3 might well combine tactical and strategic roles in one large satellite.

Phase one of the program was completed June 13, when eight of the 100-pound DSCS-1 craft, built by Philco-Ford, were successfully launched. There are now 25 operational satellites in the system.

DCA expects to issue a request for phase-two proposals sometime this summer, with launches expected to begin in late 1970 or 1971. Comparable in size to the giant Intelsat 4 craft to be built for Comsat [Electronics, June 24, p. 139], the higher-powered satellites will be launched two at a time by Titan 3C vehicles. Four satellites will make up the operational system—one over the Atlantic, one over the Indian Ocean, and two over the Pacific.

Each will be able to relay the equivalent of more than a thousand voice channels. In contrast, the smaller phase-one satellites have a capacity of 12 tactical voice channels working with the 40-foot AN/MSC-46 transportable ground terminals and eight teletype channels with the 18-foot-diameter AN/TSC-54 terminals.

Boosters have already been purchased for the phase-two effort, and the fiscal 1969 budget is said to include an estimated \$60 million to get DSCS-2 rolling. Besides relaying voice broadcasts for the worldwide Military Command and Control System, the National Emergency Airborne Command Post, and for ship-to-shore communicators, the system will provide a 500-kilobit-per-second digital data channel. Employing multiple frequency-shift keying modems from Philco-Ford, a similar data channel is now being used by DCA to transmit high-quality photographs from Saigon to Washington via the initial DSCS system.

Groundwork. A big chunk of

DESIGNERS SAY THE NEW SURMETIC 40 ZENER DIODE HANDLES 175 W SURGES† AND 5 W DC.

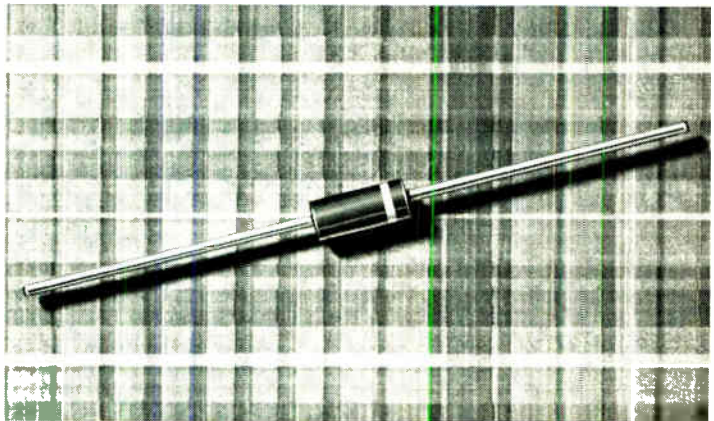

P.A.'s Say It's Cheap.

Better-than-metal cheap! In fact, the rugged, reliable and reasonably-priced 1N5333-88 plastic Surmetic* 40 series replaces more than 300 twice-as-costly, metal stud zener diodes and does **everything** these units will do for only \$1.85, 100-up . . . yet its surge capability is up to four times greater than the Mil spec for metal 10-watt units!

With leads clipped to $\frac{3}{8}$ -inch and held to 75°C, it will easily handle 5 watts P_D — 40% greater than other lead mount units under similar conditions and is the only device of its kind to conform to the proposed JEDEC method of rating a diode according to lead length/temperature.

Unique oxide-passivated junctions, 3.3- to 200-volt application capability, low leakage and complete mounting freedom (you don't have to compromise on special clips or terminals for heat sinking) complete the picture.

Send for complete data to P.O. Box 20912, Phoenix, Arizona 85036, or contact your franchised Motorola distributor.

*Trademark of Motorola Inc.
†8.3 ms, square wave

- where the priceless ingredient is care!



MOTOROLA
Semiconductor Products Inc.

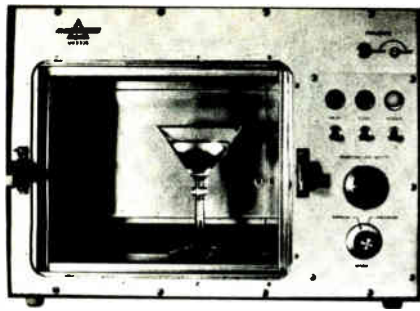

This refrigerator heats to 1000 degrees.

It also cools to
-300 degrees. It does
both with remarkable
accuracy, 0.1°.

Send for our latest
catalog.



Delta Design, Inc.
8000 Fletcher Parkway
La Mesa, California 92042
Telephone (714) 465-4141

Electronics Review

the phase-two money will go to build second-generation ground terminals and to upgrade existing stations. The new system will use more than twice as many ground stations than are currently operational. The work will proceed in three stages, the first of which will involve some modifications of existing terminals for 1971 operation. In the second stage beginning in late 1971, these terminals will be overhauled to increase bandwidth and channel capacity. The final stage is expected to start in 1973 and include a change in basic modulation and multiple-access techniques from frequency division to time division.

New fixed earth terminals also will be added during the first two stages to replace the transportable terminals now being used in the U.S.

Hughes is now designing several second-phase ground terminals, including a 40-foot fixed-site unit. The company, which had trouble in the early stages of the initial phase with its MSC-46 terminal's antenna feed horn, has now developed a horn that combines different signals in a multimode pattern to achieve better over-all aperture efficiency. Hughes has already built a 10-foot dish with the multimode feed horn and expects to get an efficiency of 70%, compared with the 45% to 50% initial aperture efficiency of the MSC-46. This level has since been raised to about 60% with the addition of Radiation Inc.'s Dialguide feed. Hughes' 3-foot-diameter shipboard antenna, the AN/SSC-3, also has an efficiency of about 60%.

Companies expected to bid for ground terminals may include Collins Radio and RCA, as well as Philco-Ford, Hughes, and Radiation.

The Navy has been having reliability problems with the shipboard SSC-3. "Most of our troubles have been mechanical," a Hughes engineer says, involving such things as air conditioning. The shipboard environment, he comments, hasn't always been what the Navy specifications stated.

The SSC-3 is only a passenger on the ship at present, being housed

in a hut. But Hughes is now working to integrate the satellite antenna right into the design of the ship. The Navy will include this integration feature in its request for proposals for an upgraded SSC-3 to be used with the phase-two DSCS program.

For the record

Back to school. Two workshops will be held this summer to acquaint college and university teachers with recent advances in d-c measurement. One will be July 22 to 26 at the Argonne National Laboratory, Chicago, and the other Aug. 5 to 9 at the University of California, Irvine. Both will concentrate on modern ratio devices.

Dial a book. The days when one can browse through library book-stacks may be numbered. An automated book-retrieval system that could double libraries' storage capacity has been developed by the library bureau of the Sperry Rand Corp. Called the ABC-801, the prototype uses optical and mechanical identification systems. A borrower selects a book from the library's card catalog and gives the volume's number to an operator. The book is delivered by an automatic "picker."

Down the drain. Now that the Victor Comptometer Corp. and Philco-Ford's Microelectronics division have confirmed that they've dropped their joint calculator venture, the calculator itself seems headed for oblivion. Philco says it has absolutely no plans for the Victor 3900, the MOS machine it built for Victor. And Victor will be marketing the Wanderer line of electronic calculators built by the Heinz Nixdorf Laboratory for Electronics in Germany. Victor owns the rights to the 3900, but it hasn't announced any plans to exercise them.

Pick out any two any time.



You'll get identical twins.

Despite temperature excursions, or any other environmental extremes, every single CORNING® Glass Capacitor will give you the same exact capacitance behavior as every other one.

So every single one of the capacitors in the timing, tuning, oscillator or multivibrator circuits you build this year will be performing identically five years from now.

You get this operating retraceability and this part-to-part repeatability, only in CORNING CYFM, CYFR, and TYO Glass Capacitors.

Get the figures on this long-term uniform stability.

Write: Corning Glass Works, Electronic Products Division, Corning, N. Y. 14830

CORNING
ELECTRONICS



COMPONENT CAPSULES

GE's 1-amp D28D transistor—try this one for low-cost control circuits

This reliable 1-amp medium-power transistor offers economy for consumer and industrial applications. Including: audio output circuits, solenoid and small motor controls, switching, high-power transistor drivers and other systems.

Fused Quartz, Fused Silica meet the unusual in application problems

Highest purity General Electric Fused Quartz is being applied in crystal pulling, zone refining, semiconductor diffusion and research labware. Many new and varied electronic applications are continuously being developed. General Electric Type

Here's reliable indication, monitoring and control—at low cost

Proved design of GE meter relays is better three ways:

- **New contactless control action** — solid-state, light sensitive switch means exceptional control simplicity, reliability.
- **"Piggyback" control module** — plug-in design

New reduced-cost thermistors for temperature sensing uses

New Economy Package 1H-Series units are ideal for volume printed circuit board application. These new GE thermistors cover a specific resistance range from 18K ohms to 56K ohms. They operate at temperatures to 275C. Dimensions are 0.150"

GE cooling fan assemblies meet reliability demands of computers

GE cooling fan assemblies offer many years continuous duty, without maintenance. The fans feature all-angle operation and efficient air flow. Two sizes are available. Small 90 and 100 CFM blowers have GE KSB33-Frame Unitized® motors.



ACTUAL SIZE D28D



Fused Quartz



4 1/2" HORIZON LINE® meter relay



500 CFM unit

100 CFM unit

Price? In the 30-cent range. And, it's NPN, planar, epitaxial, passivated in the proved low-cost GE C106 power tab package.

GE's D28D is capable of 4 watts power dissipation at 70C case; 1-amp continuous and 1.5-amp peak collector current . . . voltage selections from 30 to 75V_{CEO}.

It features excellent linearity, low saturation voltage and fast switching with an 85mHz F_T typical. Class B audio output can go to 10 watts. Leads are formable to TO-5 configuration. Interested? Circle Number 231.

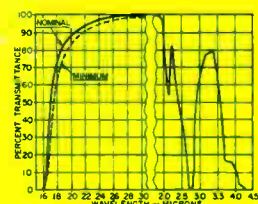

Transmittance Curve—151 Fused Silica for 1cm thickness*

151 Fused Silica, for critical optical jobs, is a schlieren grade material offering highest ultraviolet transmission.

It's the newest and highest quality optical material within GE's numerous grades.

Type 151 is ideal for use in laser optics, absorption cells, spectrophotometer optical elements and schlieren photography.

For technical data and application assistance, Circle Number 232.

* Excluding surface reflection losses

assures time-saving installation.

• **Choice of styles** — easy-reading BIG LOOK® or low-profile HORIZON LINE® meter relays.

Variety of GE meter relay functions includes energizing an alarm; close differential relaying; controlling temperature, power, speed and frequency.

Applications are virtually unlimited — from critical monitoring in hospital intensive-care units to deep-well drilling control.

GE meter relays cost less than any other comparable instruments . . . makes GE your best meter relay bargain.

New publication has ratings, dimensions, ordering and pricing data on all GE meter relays and other panel instruments. For free copy, Circle Number 233.

long, 0.070" diameter; 1.125" gold-plated Dumet leads may be welded or soldered . . . ideal for PCB's.

TYPICAL CHARACTERISTICS —1H Thermistors

Resistance Ratio; $R_{25^{\circ}\text{C}}/R_{125^{\circ}\text{C}}$	29.85
Dissipation Constant (θ); milliwatts/ $^{\circ}\text{C}$	2
Thermal Time Constant (τ); (sec.)	8
Maximum Operating Temperature; ($^{\circ}\text{C}$)	275

The units offer new opportunities in application, heating system, motor, fan and textile controls.

Authorized distributors now have Economy Package 1H-Series thermistors with resistance tolerance of $\pm 10\%$. Other tolerances available are: $\pm 5\%$; $\pm 20\%$; and $\pm 30\%$.

Prices drop when units are bought in OEM quantities. Order your copy of price and data sheets. Circle Number 234.

These units fit openings less than 4 3/4" square.

Near perfect bearing bores, accurate shaft-bearing alignment and special metered oil bearings provide hydrodynamic oil film lubrication . . . eliminates metal-to-metal contact at operating speeds.

GE's larger fan assembly, the 500 CFM, mounts on a 9.7" diameter bolt circle through holes in its anodized aluminum venturi face. A sturdy grill serves as motor support.

Long life of the 500 CFM is enhanced by its GE KSP11-Frame unit-bearing shaded-pole motor.

Many variations in specifications are available for both sizes of GE fan assemblies. Circle Number 235.

A TECHNICAL DIGEST FOR INNOVATORS OF ELECTRONIC EQUIPMENT

Application flexibility combines with low cost in this 4-ampere SCR

General Electric's time-proved C106 planar, passivated SCR is ideal for gas ignitions, motor control, sequential light systems, malfunction sensing, appliance control and other uses.

C106 price is low: in the 35-cent range. And, it's always a reliable

Want versatility? Check these new snap-acting limit switches

Small. Durable. Precise. With maximum flexibility! These limit switches are built to a designer's needs.

The CR115JA is rated to 600 volts a-c; 6 amperes break. Contacts are SPDT. Size is only 1" high x 1 1/2" wide x 1 1/2" long. Terminals are

How about this for reed switch contact stability!

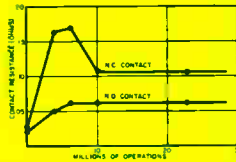

Excellent contact resistance stability is just one feature of the new GE DR138 Form C (single-

New 4-pole latching model joins 150-grid sealed-relay family

Introducing the smallest 4-pole latching relay on the market: GE's Type 3SBM.

This new sealed relay is only 0.32" high, 0.31" wide, and 0.61" long.

Don't let the smallness fool you. This relay's big on performance. Its contact rating is 2

New data modems let you meet almost any digital communications need

General Electric offers a complete line of digital data modems.

It's the new DigiNet Series, capable of handling your digital data requirements at speeds from 60 bits to 250,000 bits per second.

Twenty-two separate models are available.



C106

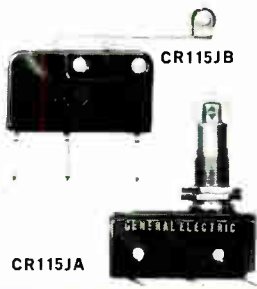

CR115JA



ACTUAL SIZE



Desk-top Cabinet

performer.

Now the RMS rating has been extended to 4 amps; peak current increased to 75 amps and surge current to 20 amps—at no increase in cost! It takes only 200µA/0.8V max signal to control 4 amperes or a current gain of 20,000.

Several lead configurations allow mounting versatility. Voltage ratings are available to 300V . . . soon to 400 V. Circle Number 236.

screw type or push on. A variety of operators is available.

Applications include electrical interlocks, pilot signals, computers, vending machines, light material handling systems and industrial devices.

The CR115JB is GE's smallest limit switch, only 5/8" high x 1 1/2" wide x 1 1/2" long.

It's rated to 600 volts a-c; 3 amperes break. Contact form is SPDT. Terminals are screw or combination push-on solder. A variety of operators is available.

Applications include electrical circuit interlocking, small appliances, business machines, process and packaging machinery. Circle Number 237 for details.

pole, double-throw) reed switch.

Contact rating is 5 watts (50V at 100 mA) d-c resistive. Expected life: 20 million operations (tested at full load, 50 volts d-c, 0.1 amp, 20 ops/sec). Initial contact resistance limit: 100 milliohms.

The new DR138 reed switch is suited for reed-relay and communication jobs in commercial, industrial, or military markets. For all the facts, Circle Number 238.

amps. And, it meets or exceeds MIL SPEC environmental and electrical requirements.

Radiation hardening and all-welded construction enhance reliability of the Type 3SBM.

Like other GE 150-grid relays, the 4-pole latching form may be selected with a variety of options. You have a choice of coil ratings for a wide range of system voltages, plus popular mounting forms and header types.

For the full story, Circle Number 239.

You can specify them in EIA standard rack mounts, stylish desk-top cabinets or even CCITT Standard "shallow-depth" racks.

DigiNet units feature high MTBF and exceptionally wide environmental specifications.

GE DigiNet modems and standard plug-in modules can be easily integrated into your equipment and systems. Find out how. Circle Number 240.

FOR THE NEW IDEAS IN ELECTRONICS, look to General Electric—your best single source for electronic components.

ELECTRONIC COMPONENTS SALES OPERATION

GENERAL  ELECTRIC

5 things you should

3. Applications:

Fairchild MOS FETs are excellent amplifiers. They're also the closest thing to an ideal switch. They've got high input impedance, zero offset voltage, wide dynamic range, low cross modulation, and good noise figure. They're perfect for analog and digital switches, high speed solid-state choppers and amplifiers from DC through UHF frequencies.

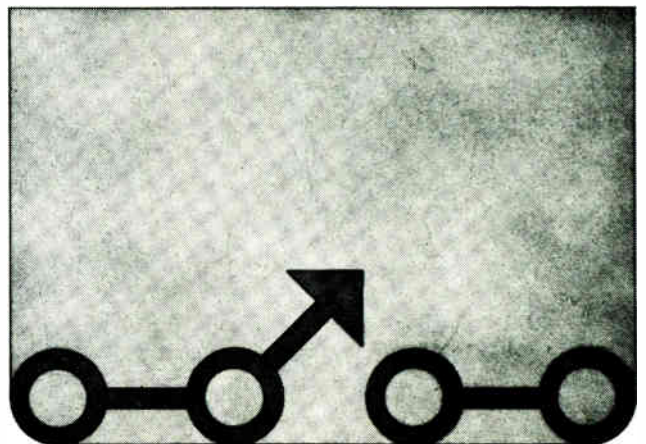

1. Gate protection:

MOS FETs used to be so sensitive, they'd burn out in your hand. Fairchild has solved the problem with Gate Protection. It's provided by our unique integrated diffused resistor Zener diode. The resistor, in series with the gate capacitance, provides an RC time constant. Any transient static charge applied to the gate is delayed until Zener breakdown. The charge is then shunted through the Zener to ground.

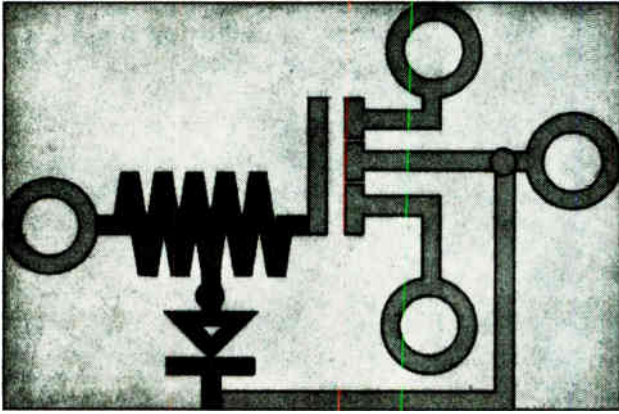

2. Stability:

Some MOS devices have unstable thresholds. That usually means there are many free positive ions in the oxide. Fairchild's patented Planar II* process reduces the number of ions and keeps them under control. Under worst case bias conditions, the average Fairchild MOS FET will experience less than a six percent threshold change over 1000 hours of operation. That's better stability than any bipolar device made. Even ours.

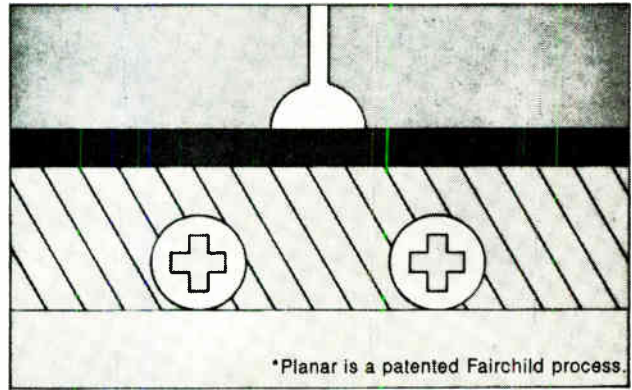

know about mos fets:

4. The price:

When MOS FETs first came out, they cost about five times as much as bipolars. Now, they don't. In fact, you can't afford *not* to use them.

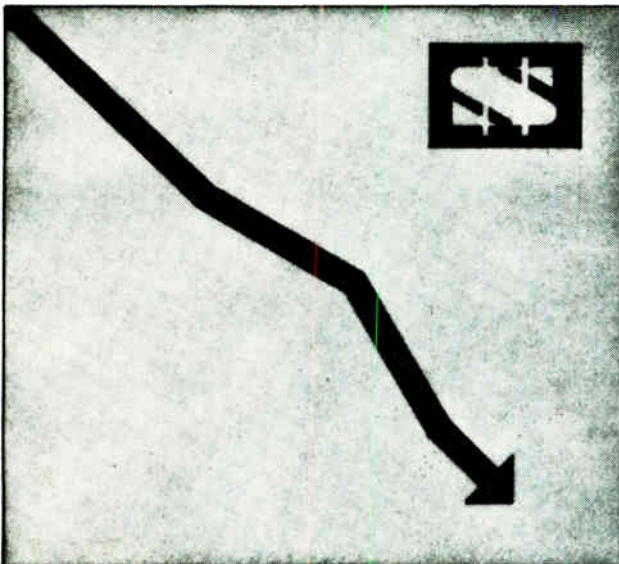

5. The kit:

To prove our specs are in the right place, we've prepared a sample kit to help you get involved with MOS FETs. It's worth \$160.10. You can buy it from any Fairchild distributor for \$39.95. You can also get a bundle of applications information. Free. Just circle the Reader Service Number below.

Fairchild Semiconductor A Division of Fairchild Camera and Instrument Corporation, 313 Fairchild Drive, Mountain View, California 94040
FAIRCHILD
 SEMICONDUCTOR
 (415) 962-5011 TWX: 910-379-6435

QUANTITY	DEVICE	APPLICATION	DOLLAR VALUE
2	FT701	Dual Differential Amplifier	\$ 20.00
2	3N147	Series/Shunt Chopper	18.00
2	3N148	Dual Analog Switch	30.00
2	FT703	High Gain Amplifier	18.00
2	3N149	Low On-Impedance Switch	12.00
2	3N150	Large Signal Switch	24.00
4	FT704	Small Signal Amplifier	18.00
2	3N145	Low Capacity Switch	8.10
2	3N146	Small Signal Switch	12.00
			\$160.10



**lower
attenuation...**

**higher
power**

8" diameter flexible HELIAX® coaxial cable

8" Air dielectric HELIAX coax extends the advantages of flexible cable to very low attenuation or very high power applications that formerly required rigid transmission line.

Corrugated inner and outer copper conductors accommodate thermal expansion without the need for sliding contacts. End connectors mate with 6 1/8" EIA flanges and lock inner and outer conductors together to eliminate differential expansion.

The continuous, connector free cable assures freedom from the VSWR "spikes" associated with the periodic inner connectors of rigid line in a long feeder. Cable assemblies can easily be electrically tested on the reel to assure your exact system performance. For complete details write Andrew Corporation, 10500 West 153rd Street, Orland Park, Illinois 60462.

HJ 10-50 HELIAX COAXIAL CABLE

	At 30 MHz	At 600 MHz
Attenuation	.027 dB/100 ft	.15 dB/100 ft
Average Power	300 kW	58 kW
Other Power Ratings	For SSB, 200 kW PEP with antenna VSWR of 3:1 2 Megawatts Peak	TV transmitter power ratings, 223 kW at Channel 4 and 70 kW at Channel 35



2-88

Washington Newsletter

July 8, 1968

**Some at NASA rap
apathetic attitude
to parts failure . . .**

Some NASA officials are openly critical of both industry and the agency itself for not moving to solve the many parts reliability problems that have been plaguing the space program. What's bothering them are such things as solders that crack, electrical connectors that don't connect, and tape recorders that conk out.

A number of concerned officials are calling for immediate action. But one experienced NASA manager says "it's pretty obvious that the agency's Office of Advanced Research and Technology is the one that should be carrying the ball." This official cites the apathy with which connector problems are met. **'We've been struggling with faulty and unreliable connectors for years. NASA knows it and the manufacturers know it, but neither will do a damn thing to correct the problem.'**

One example of the present attitude: a memo out of NASA headquarters in March stated that a meeting with industry on parts reliability was to be held as soon as possible [Electronics, April 1, p. 45]. The meeting has yet to take place.

**. . . but the agency
sets crash program
to improve bearings**

There is one parts reliability problem, though, that will get some attention at NASA. **A crash program to improve bearings will be conducted by Marshall Space Flight Center.**

Problems with ball bearings have become increasingly severe in the Apollo program's gyros and accelerometers. Unless something is done, the guidance and control system may present a hazard in future manned space flights. "I hate to admit it," says one official involved in testing the gear, "but the performance of some instruments has been downright lousy and all because of ball bearings."

**New law bugs firms
making snoop gear**

The Justice Department is getting worried inquiries from manufacturers of "bugging" equipment concerning the section of the recently enacted "safe streets" bill that forbids the sale of eavesdropping devices to any but government agencies. Businessmen are wondering, among other things, how they can sell or advertise such devices, and whether the rule applies to transactions already in progress when the law was signed June 19. These questions will probably have to be settled in court—or by an amendment—since the law provided for no grace period.

All Justice Department spokesmen will say is that this section of the law is "open to interpretation." **They advise inquiring businessmen to find a good lawyer.**

The law may eventually benefit the manufacturers. It's sure to open a larger "official" market since local law-enforcement agencies are being given broader eavesdropping rights than they had before.

**Phone firms to stall
foreign attachments
despite FCC ruling**

Although the FCC has ruled that "foreign attachments" can be tied directly into telephone-company equipment, **there remains the question of when the first such tie-ins will be made.** The commission's decision on an application by the Carter Electronics Corp. of Dallas on behalf of its Carterphone device was not entirely unexpected [Electronics, June 10, p. 80], though it does overturn the traditional telephone-company

Washington Newsletter

ban on such attachments.

Since the FCC did not establish any performance standards to insure that the attachments won't degrade phone systems' technical quality—leaving this to the phone companies themselves—there is no telling when the attachments will make their bow. **The phone companies are expected to seek court injunctions against the attachments until standards are established, or to appeal the FCC ruling itself.** Either move will delay any implementing of the decision.

Lack of funds may slow Navy missile

The advanced surface missile system (ASMS) that's slated to replace the Talos and Standard missiles aboard 100 Navy ships during the 1970's is still proceeding on schedule. It made it through the Senate and is now awaiting House approval. **But there's a good chance that the Pentagon's financial problems will force a stretchout of the program.** "Right now, no one can say what will happen to the program," says one Defense official. "It's too early in the fiscal ballgame."

The multipurpose phased-array radar system has been modified somewhat to take advantage of technology developed for the Army's Sam-D, which is also facing a stretchout. The Navy expects to receive contract definition proposals in August from North American Rockwell, RCA, General Dynamics, Westinghouse, Boeing, and Sperry Rand. It wants to award definition-phase contracts by October and hopes to begin development early next year.

North Electric borrows from past to win Army award

The North Electric Co. of Galion, Ohio, has gained a **preeminent position in the electronic-switching portion of the military communications market** by winning a contract for the Army's tactical automatic switching system. Chosen for the first operational test of the system is the Seventh Army in West Germany. North won with a bid of \$4,115,000.

The Army's new equipment will be similar to the Air Force's 407L tactical air control system, which uses electronic switching centers made by North [Electronics, May 27, p. 74]. The company was, until two years ago, a subsidiary of the Swedish telecommunications firm, LM Ericsson; its system is based on early Swedish developments in the field.

Addenda

Rumors are flying around Washington as the August deadline approaches for the report of the President's task force on telecommunications. **One rumor making the rounds has the task force urging that all ultrahigh-frequency television stations be taken off the air and put on cable.** This action would clear the valuable 470-to-890-megahertz band, which could then be used, so the story goes, primarily for land mobile radio. But even if such a change was urged, insiders say it's unlikely it would be accepted . . . **If cutbacks in nonessential military spending postpone follow-on orders for the Combat Service Support System (CS3) that IBM is building for the Army [Electronics, June 24, p. 145], the company could lose as much as \$100 million worth of business.** This summer, IBM will deliver the last of the five CS3's specified in the initial order. Each \$2 million system with its 360/40 computer enables field commanders to keep tabs on troops, equipment, and spare parts. The Army holds options on 44 additional systems. **After indications that the Defense Department wouldn't permit the service to exercise them,** the Army rounded up top officials last month for a demonstration of the CS3.



The QRC solves the size / power / regulation problem by combining all silicon, low-voltage series regulator circuitry with high-speed transistor switching techniques.

Sorensen High Performance QRC Series:

The QRC Series covers a wide target area without performance trade offs. Standard features include excellent regulation for voltage and current, fast response time ($\leq 25\mu\text{sec.}$), and surprisingly small size for power outputs to 1200 watts at ambient temperatures to 71°C.

Some laboratory power sources offer high power levels, but are bulky and, by today's standards, are unregulated. Others offer excellent regulation specifications, but are inefficient and, if high-power levels are desired, become large heat sinks. Sorensen QRC's are high efficiency, compact power sources which have excellent performance characteristics with prices

starting at \$325. Seven models are available from stock, covering the range of 0-40Vdc at currents to 30 amperes.

Additional features resulting from the utilization of sophisticated regulation techniques include low ripple ($\leq 1\text{mV r.m.s.}$); output voltage and current resolutions of 0.01% and 0.05%, respectively; remote programming in both the voltage and current modes; remote-sensing and a solid state automatic-crossover indicator.

Contact your local Sorensen representative or: Raytheon Company, Sorensen Operation, Richards Avenue, Norwalk, Connecticut: 06856, TWX 710-468-2940.



for more data on this versatile instrument . . . **Call Sorensen: 203-838-6571**

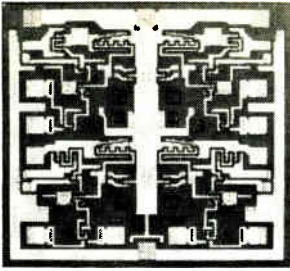

**Today
one company is being
called the
“production house
of the industry”
by
engineers who specify
integrated circuits.**

**The name
is getting around.**

MOTOROLA SEMICONDUCTOR PRODUCTS INC.

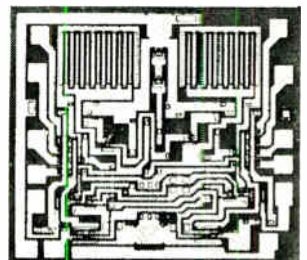

New complementary negative output series lets Helipot fill all your dc voltage regulator requirements – positive and negative.

12 Outstanding features on the negative:

- $\pm 0.05\%$ regulation
- short circuit proof models
- small size—0.5 sq. in.
- low profile—0.170"
- up to 5 amps load current
- fully sealed
- -3 to -21 volts output range fixed and adjustable
- hybrid cermet construction
- -55°C to +125°C
- up to 60 db ripple attenuation
- mil spec tested
- self-contained models, require no external components

Voltage Range	Positive		Negative	
	Fixed Output	Adjustable Output	Fixed Output	Adjustable Output
3 to 9 volts	Series 805	Model 806	Series 855	Model 856
9 to 21 volts	Series 801	Model 802	Series 851	Model 852
21 to 32 volts	Series 803	Model 804		
	Reader Service No. 505		Reader Service No. 506	

The price (1 to 9 quantity):

- \$30.00—fixed output models
- \$35.00—adjustable output models
(delivery from factory stock)



Positive or negative, Helipot fills your complete voltage regulator requirements.

Shown here is Model 851 Negative output DC Voltage Regulator – one of Helipot's four negative, hybrid cermet thick film units with outputs from -3 to -21 volts. Also available are 6 positive models with outputs from +3 to +32 volts.

For complete information on our unique *Negative* and *Positive* regulators, simply circle the appropriate number on the reader service card—or contact your local Helipot Sales Representative.



INSTRUMENTS, INC.
HELIPOT DIVISION
FULLERTON, CALIFORNIA • 92634

INTERNATIONAL SUBSIDIARIES: GENEVA; MUNICH; GLENROTHES, SCOTLAND; TOKYO; PARIS; CAPE TOWN; LONDON; MEXICO CITY

Technical Articles

**Lock-in voltmeters
remove noise
page 80**

A synchronous technique using a lock-in voltmeter removes noise from a low-level signal. The voltmeter locks on to a synchronous signal and rejects the noise, which is nonsynchronous. This method is free from the zero-drift and zero-error problems that plague a-c and d-c techniques.

**Avalanche-diode
outputs go up
page 96**

Techniques for improving heat dissipation and fabricating abrupt junctions have made avalanche diodes strong contenders for a place as microwave power sources. One recent development is an ultrasonic scrubbing method that makes it easier to flip-chip the diode. Another is a method of growing double epitaxial layers on a substrate to sharpen the demarcation at the junction and thus increase efficiency at low currents.

**Crystals store
light and current
page 104**

Electronics



Though a way of exciting luminescence in certain crystals by mechanical tapping was discovered back in 1960, the causes and physical models have been explained only recently. It's now been shown that when class II-VI compound semiconductors are doped with sodium and stimulated optically, their conductivity rises sharply and remains high. If they're then tapped, they give off light. Doped with lithium and stimulated thermally, the crystals also emit light when tapped. Applications for the large single crystals now being built include use as infrared detectors, image intensifiers, computer memories, and diode lasers.

Coming

Micro-Minac

A navigational computer that uses digital techniques to take over analog functions is an exact size, pin-for-pin replacement for analog units.

Taking noise out of weak signals

The synchronous method of cleaning up microvolt or nanovolt transmissions with a lock-in voltmeter is free of zero-drift and zero-error problems

By Richard Brower

Brower Laboratories Inc., Westboro, Mass.

Noise voltages are present in all kinds of electronics systems and since they are in millivolts, they overpower weak microvolt or nanovolt signals. That means the engineer trying to pick a low signal out of the noise runs into trouble.

For example, the designer of a microwave antenna may measure false loads produced by interfering signals. The biomedic may miss the faint wiggle of an electrocardiogram and misinterpret a heart condition, and a photo-optic engineer might see light when he shouldn't.

A technique, still too new to be widely used, combined with a lock-in voltmeter that is itself only a year old, eliminates the problem. Unwanted noise is rejected and only the weak signal remains.

Such a synchronous system locks in on the repetitive signal, rejecting noise and interfering frequencies. The lock-in voltmeter is equivalent to a narrowband tuned a-c voltmeter, but it has a very high Q that conventional tuning methods can't get. Moreover, tuning and frequency-instability problems that plague conventional high-Q tuned circuits cease to exist. The sync method is also free from problems of zero drift and zero error, which are among the major drawbacks of a-c and d-c methods [see "Comparing previous methods," p. 82].

Outlining the problem

In any application, one type of noise usually dominates the others. This primary source of noise may be any one of the following: random fluctuations of energy in the true signal; the signal detector; faulty connections (particularly the leads from detector to amplifier) or ground loops; the amplifier; mechanical vibration; magnetic or electrostatic pickup from the power line, nearby radio transmitters or oscillators; or switching transients from relays, motors, and other components in the system.

Before an engineer can understand how a lock-in voltmeter is able to extract a low-level signal from

such noise voltages, it is helpful for him to understand how noise is produced and what its effects are on an electrical system. As an example, consider a photometric system—comprising a source, detector, amplifier and recorder—used to measure a spectrum produced by the radiation source. To obtain the maximum resolving power of the system, the optical spectroscopist would often like to narrow his slits, but narrower slits mean fewer photons and less signal. Reduction of noise levels in this case may give an improvement in the quality of spectroscopic data.

Thus, aside from the optical and physical problems, the experimenter must also be able to solve difficult electrical problems if his measurements are to be meaningful. Each type of radiation detector will have a different impedance, intrinsic noise, and operating environment, and for optimum results each detector requires matched-impedance input circuitry. Also, the electrical signal is so weak that great care must be taken in designing the link between detector and amplifier.

The basic requirements for accurate measurements can be summarized as:

- Reduce zero drift and gain errors to a negligible point.
- Minimize system noise to that of the detector and the source.
- Check the performance of the whole system frequently.

The basic approach

In a synchronous system, a lock-in voltmeter is substituted for the amplifier and a chopper blade is inserted between the source and thermocouple detector.

When the chopper blade is rotated at a constant speed, the thermocouple detector produces a fluctuating voltage at the signal input. This is because light gets through the chopper blade only during

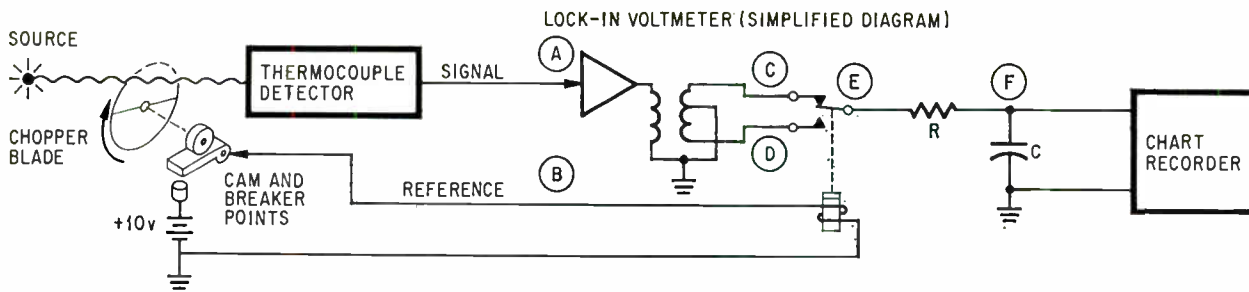

Synchronous system. Lock-in voltmeter, in color, replaces amplifier in basic sync system; chopper blade is rotated at a constant speed between the source and detector. At input A, detector produces a square-wave voltage, with amplitude proportional to radiant energy, superimposed on d-c and noise voltages.

every half-rotation; the system is automatically rezeroed once per cycle. The signal consists of a square wave—whose amplitude is proportional to the radiant energy—superimposed on a continuous background of d-c and noise.

In the lock-in voltmeter, the d-c part of the signal is rejected, while the noise and square-wave component are amplified and fed into a transformer that supplies push-pull signals to the relay contacts. The breaker points and cam are adjusted to synchronize the relay drive voltage with the push-pull signals from the transformer. The positive half-cycles of the push-pull signals are mixed by the relay to produce a full-wave rectified output, with the noise superimposed on it. Random noise fluctuations, however, average out over successive half-cycles of the relay and thus don't produce a d-c output. To get rid of any remaining noise, the d-c signal is filtered by an RC network before being applied to the output terminals of the voltmeter.

Thus, when the synchronous system is used to make the output measurement the results are significantly better. For example, in an ideal case, there is complete freedom from zero error and greatly improved measurement accuracy. This is because the system measures only the instantaneous difference in the signal level between the light and dark cycles of the chopper blade. Thus, the system is automatically rezeroed once per cycle.

Designing the system

One of the main considerations in building the system is designing the voltmeter so it doesn't generate its own noise. This requires designing the detector in such a way that its characteristics will match those of the voltmeter.

Any detector may be represented by a signal generator with an internal series resistance, R . In a thermocouple, R may be as low as 2 ohms or as high as 1,000 ohms. In a photomultiplier tube, the series resistance R is theoretically infinite, because the photomultiplier is a constant-current device, and a

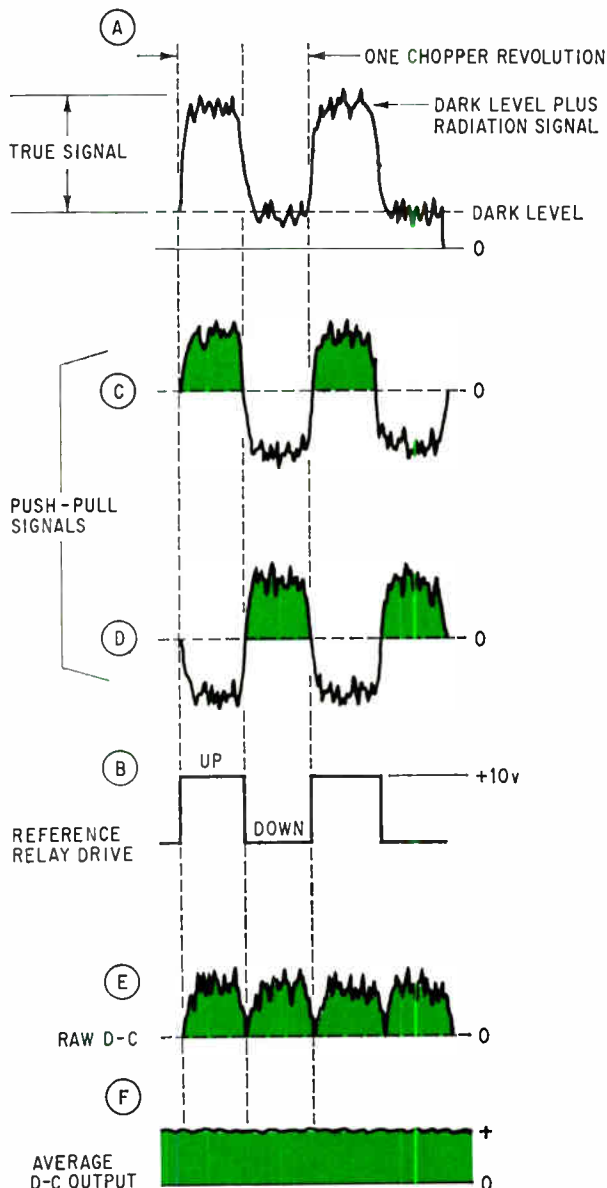

Waveforms. Analysis of signals as they travel through the system. Color in waveforms indicates desired signal.



Photometric system. Four basic components in any photometric system are a source, detector, amplifier, and recorder. Noise is introduced by the detector because the signal level at its input is much smaller than the noise voltage.

Comparing previous methods

Before the advent of synchronous technique, an engineer faced with the task of removing a low-level signal from one mixed with noise had only a d-c or a-c system to choose from—both have limitations. The d-c system has zero error and zero drift; the a-c system cannot be built with high Q's, and even if it could, would not be frequency-stable.

In a straight d-c measurement of the energy radiated by a source, an engineer might use a thermocouple or thermopile as a detector, because these exhibit a constant sensitivity regardless of wavelength. The thermocouple is connected to a high quality d-c microvoltmeter, and all necessary precautions are taken to prevent zero drift and errors due to contact potentials. An output-chart recording for such a system would indicate the thermocouple voltage when the source is switched on and off.

Even with the source off, a varying d-c error is produced due to the ambient temperature of the thermocouple junction. The true signal measurement is the difference between the ambient signal level and the total signal, and thus a d-c offset voltage must be subtracted from the signal voltage to correct for the zero error. As the engineer attempts to measure weaker signals, he finds that they are eventually lost in the fluctuating d-c zero level. The same conditions exist for photomultiplier tubes that produce an output current under dark conditions.

Since there is no correlation between the ambient temperature and the zero offset voltage used to buck out the error, most measurements with d-c systems are plagued with zero drift problems.

A-c system. If a conventional a-c voltmeter is used in place of the d-c voltmeter to detect the chopped detector signal, it will also reject the d-c

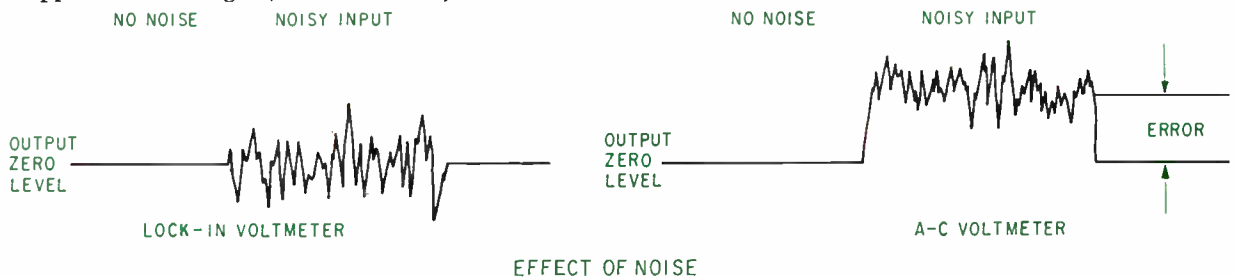

Shiftless. With the lock-in voltmeter in the system, no shift in output d-c level occurs.

shunt load resistor then establishes the source impedance. To determine the amplifier requirements for these radically different devices, it is helpful to examine the characteristics of a typical amplifier—a vacuum-tube amplifier stage or a field-effect transistor with its input shorted to ground.

For this circuit, E_{out} fluctuates around an average zero level. If the noise voltage E_{out} is measured with an a-c voltmeter and divided by the gain of the amplifier, the equivalent input noise voltage is obtained under short-circuit conditions.

Because this noise voltage varies as a function of both frequency and bandwidth, it's customary to tune the a-c voltmeter to a 1-hertz bandwidth and

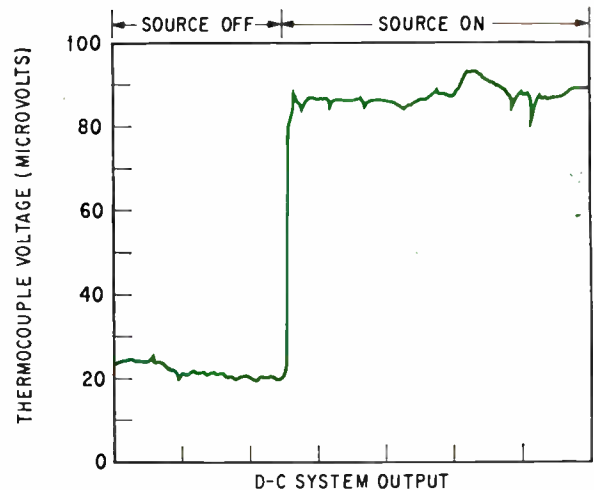

D-c output. Even though the source is off, plot of the d-c output indicates an error voltage due to the ambient temperature of the thermocouple junction.

background signal. However, it will not give similar rejection of fluctuating noise components even if it is tuned to the chopper frequency with the same equivalent bandwidth as the lock-in voltmeter. This is because the a-c voltmeter produces a d-c output as the input noise level is increased, whereas the lock-in voltmeter does not produce a d-c output as the result of noise. It produces increased noise on the output; the average level remains the same.

The tuned a-c voltmeter, however, will rectify a portion of the noise to cause a shift of its output d-c level. This results in a serious measurement error.

plot the amplifier noise as a function of frequency. The noise amplitude increases at low frequencies because of flicker noise; such increases are characteristic of virtually all amplifier stages.

A pure resistance produces a Johnson noise voltage that can be calculated from the relationship:

$$\text{Noise voltage} = \sqrt{K \times \text{temperature} \times \text{bandwidth} \times \text{resistance}}$$

where K is related to the Boltzmann constant. Because both temperature and bandwidth are usually constant, the noise voltage can be converted into equivalent noise resistance. This resistance, R_N , is plotted at the bottom of page 83.

This value of R_N appears as a resistor in series with the amplifier input, and should be as low as possible to hold down noise.

The matching formula

The big advantage in expressing an amplifier's performance in terms of its equivalent noise resistance is that this allows rapid evaluation of the system's performance. Mating the equivalent diagrams of the detector and the amplifier shows that if R_N equals the detector impedance, R_S , half the noise is due to the amplifier and half to the detector. The noise is defined as the square root of the sum of the squares. In this case, the noise is 1.4 times worse than that obtained with the best amplifier. If R_N is a third of the source resistance, the total noise produced by the amplifier is only 1/9 that of the detector.

In any application, therefore, the proper matching conditions can be quickly determined by simply comparing the detector resistance with R_N . For best results, the detector should have at least three times the noise resistance of the amplifier.

Many detectors, including thermocouples, produce only Johnson noise, and the amplitude of the noise is proportional to the resistance of the detector. Lead sulphide cells and most other semiconductors generate additional noise because of the bias current that passes through them. Photomultiplier tubes are usually operated with enough anode voltage to produce a high current gain in the tube. Thus, the output shot noise of the photomultiplier is much larger than the Johnson noise of the load resistor.

Nevertheless, the most dependable and easily checked matching condition is achieved when the input amplifier design is limited only by the Johnson noise of the detector.

For every application, a chart showing equivalent noise resistance versus frequency should be obtained for the input amplifier. If this isn't available, the equivalent noise resistance should be measured.

If the detector impedance is in the megohm range, however, another problem arises. Many amplifiers produce a minute leakage current in the detector's resistance. When this resistance is made very large, the current can produce a noise voltage across the input that exceeds the Johnson noise—and the system then isn't detector-noise-limited as it should be. The only remedy is to substitute an input amplifier that has exceptionally low leakage current. When an amplifier with both low voltage noise and low current noise is used, minimum noise is obtained with the greatest range of detector impedances.

Transforming the situation

When the detector impedance is lower than R_N , an input impedance transformer is required. If this transformer is properly selected, it can result in a system that is detector-noise-limited even with impedances as low as 1 ohm.

The following are important points:

- Step-up turns ratio of the transformer should be

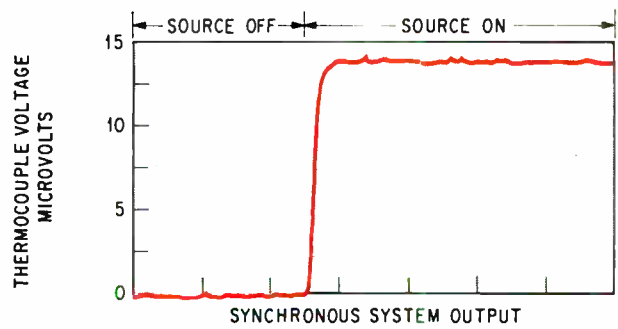

Synchronous output. With the source off, no error voltage occurs.

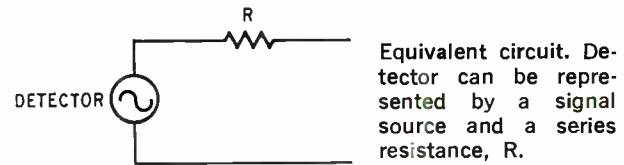

Equivalent circuit. Detector can be represented by a signal source and a series resistance, R.

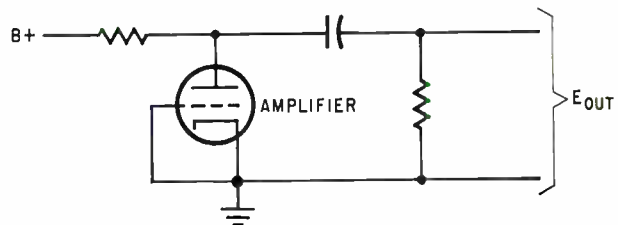

Measuring noise voltage. With the grid shorted to ground, E_{out} fluctuates around a zero level. If the value of E_{out} measured with an a-c voltmeter is divided by the gain of the amplifier, an equivalent input noise voltage is obtained for short-circuit conditions.

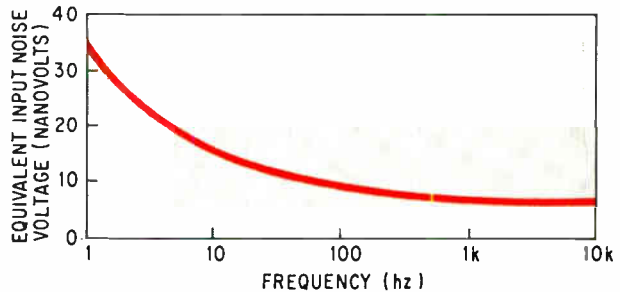

Flicker noise. Plotting the equivalent noise voltage at several frequencies reveals that the noise amplitude increases at low frequencies because of flicker noise.

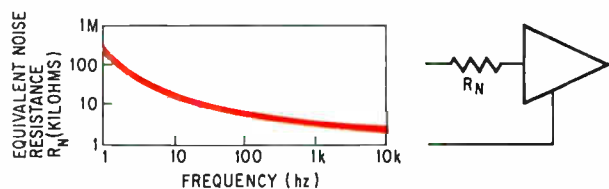

Johnson noise. Noise that enters the amplifier is due to the Johnson noise. In the equivalent circuit this can be represented as a voltage developed across the amplifier's equivalent noise resistance, R_N . If R_N is plotted against frequency, the designer can see that small values of resistance are necessary to match the detector and amplifier.

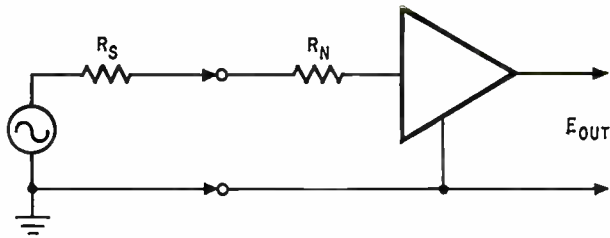

Mating circuits. If R_N and R_S are equal, half the noise will be due to the detector and half to the amplifier. However, the detector resistance should be three times the value of R_N to make the detector noise-limited.

$$\frac{N_{SEC}}{N_{PRI}} = 2 \sqrt{\frac{\text{Equivalent noise } R}{\text{Detector } Z}}$$

- Primary input impedance must be large enough to prevent loading of the detector at the lowest operating frequency. Because this input impedance is determined by the inductive reactance rather than the d-c resistance, the following rule applies:

$$\frac{\text{Primary inductance (henrys)} \geq}{\text{Detector impedance } (\text{ohms})} \\ \text{Frequency (hz)}$$

- D-c resistance of the windings should be kept as low as possible, because it appears as a resistance in series with the amplifier or detector. This will cause increased Johnson noise and must be minimized by choice of the proper transformer. In any case, the resistance of the transformer primary winding should be less than a third of the detector Z . The secondary resistance should be less than a third of R_N .

- Secondary stray capacitance must be low enough to prevent loading of the detector at the highest operating frequency. This usually isn't specified, and it's hard to measure. This loading condition can be avoided by operating the transformer only up to its self-resonant frequency.

- Multiple magnetic-alloy shielding on the transformer should be used to prevent power-line hum pickup. If possible, the transformer should also have hum-bucking construction.

- Core material and size must be chosen to prevent saturation and nonlinearity on the largest signal level expected.

- The entire transformer should be vacuum-impregnated with epoxy and potted to prevent microphonics.

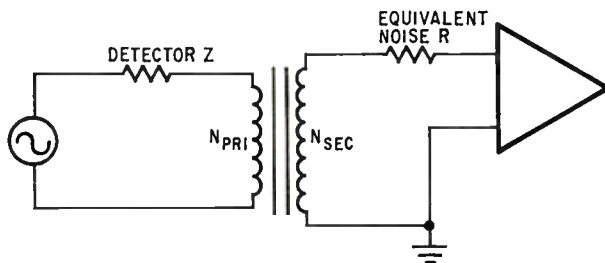

Impedance matching. If the detector impedance is lower than the amplifier noise resistance, a transformer is required to increase the detector impedance.

The transformer should be tuned to the frequency of operation. This is done by connecting an audio oscillator to the primary through a series resistance 50 times larger than the detector impedance. Then tune for peak amplitude while monitoring the secondary with a scope.

Semiconductors limit noise

Lead sulphide cells and many of the other semiconductor devices used in the system operate by varying their resistance in proportion to the level of incident radiant energy. Therefore, they are biased with a d-c current so an a-c signal voltage is produced when the radiant energy is chopped. Because the d-c voltage is connected through a resistor and capacitor directly to the high-gain amplifier input, an extremely quiet power supply must be used. Because noise levels as low as $1 \mu\text{V}$ to $10 \mu\text{V}$ can't be achieved with conventional solid state sup-

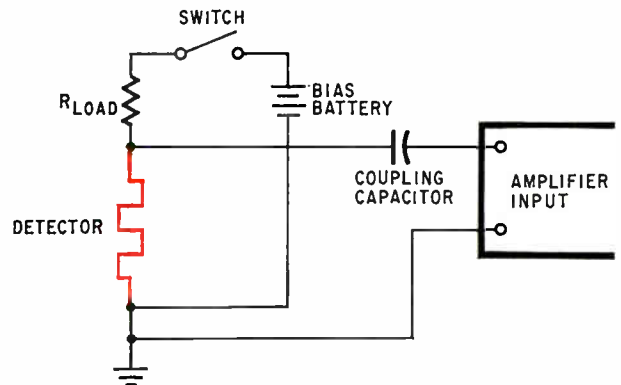

Semiconductor bias. Battery enables an engineer to vary the resistance of a semiconductor in proportion to the level of incident radiant energy. The battery also makes it possible to produce an a-c signal voltage when the radiant energy is chopped.

plies and because little current is required, batteries are preferred. They should be relatively new to guarantee a low noise level.

To help prevent stray noise pickup and ground-loop errors, the leads must be kept short, and the battery must be grounded to the same point as the detector and amplifier. The load resistor should be a high-quality metal-film type for low noise, and the coupling capacitor should be a low-leakage type, hermetically sealed in a metal can for low microphonics.

Photomultiplier precautions

Photomultiplier detectors are current amplifiers whose gain is controlled by the high voltage across the dynode network. (A dynode is an electrode whose function is secondary emission of electrons.) Because the photomultiplier's output current remains constant regardless of the load resistor used, the signal voltage increases in direct proportion to the load resistance.

However, the Johnson noise voltage of the load

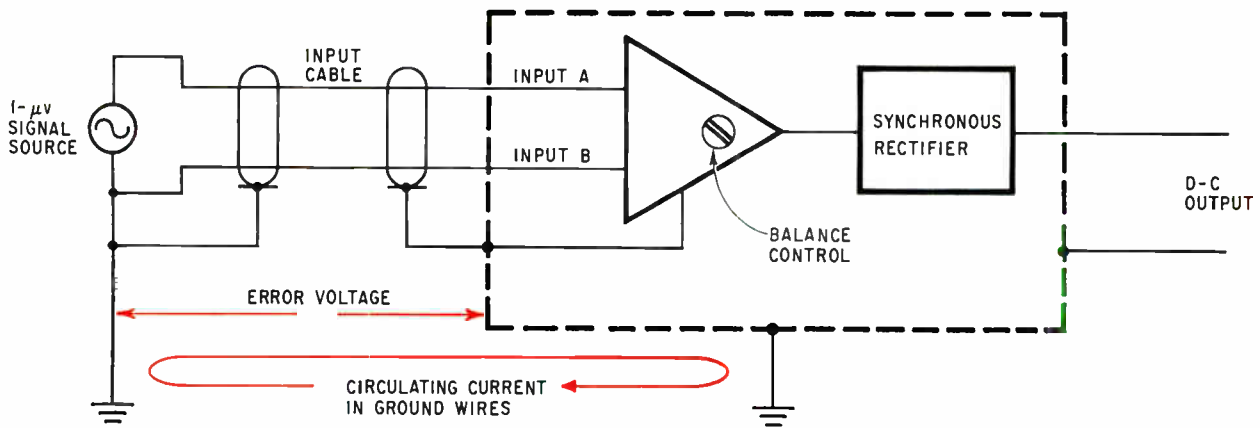

Differential amplifier. Multiple grounds between the source and amplifier chassis provide a good path for circulating ground-loop currents. The currents introduce an error voltage.

resistor increases only in proportion to the square root of the load resistance. Therefore, for a small signal current, the signal-to-noise ratio will be improved 10 times if the load resistance is increased 100 times.

The expensive 10- to 15-dynode tubes, however, have very high current gain, and amplify their cathode shot noise to the point where it's much larger than the Johnson noise of the load resistor. With these tubes, any value of load resistance 10 times larger than R_N will result in a system that is ideal—or limited by photomultiplier shot noise.

In the more inexpensive photomultiplier tubes, or in tubes with certain cathode surfaces, the high voltages on the dynode network must be kept relatively low to prevent additional noise due to ion bombardment of the structure. This limits the cur-

rent gain ahead of the load resistor. The largest possible load resistance—10 to 100 megohms—must be used with these tubes.

With very large load resistors, the input amplifier must have extremely low current noise. It must also have very low input capacity to prevent shunting of the load resistor at higher frequencies. Usually, a cable with a driven shield or a buffer amplifier must be used so the system's gain will be determined by the precision load resistor rather than stray input capacity. For example, at a chopping frequency of 30 hz with a 50-megohm load resistor, only 10-picofarad shunt capacity is permissible for a 10% loss of gain.

Eliminating ground-loop errors

In almost any low-level detection system, exces-

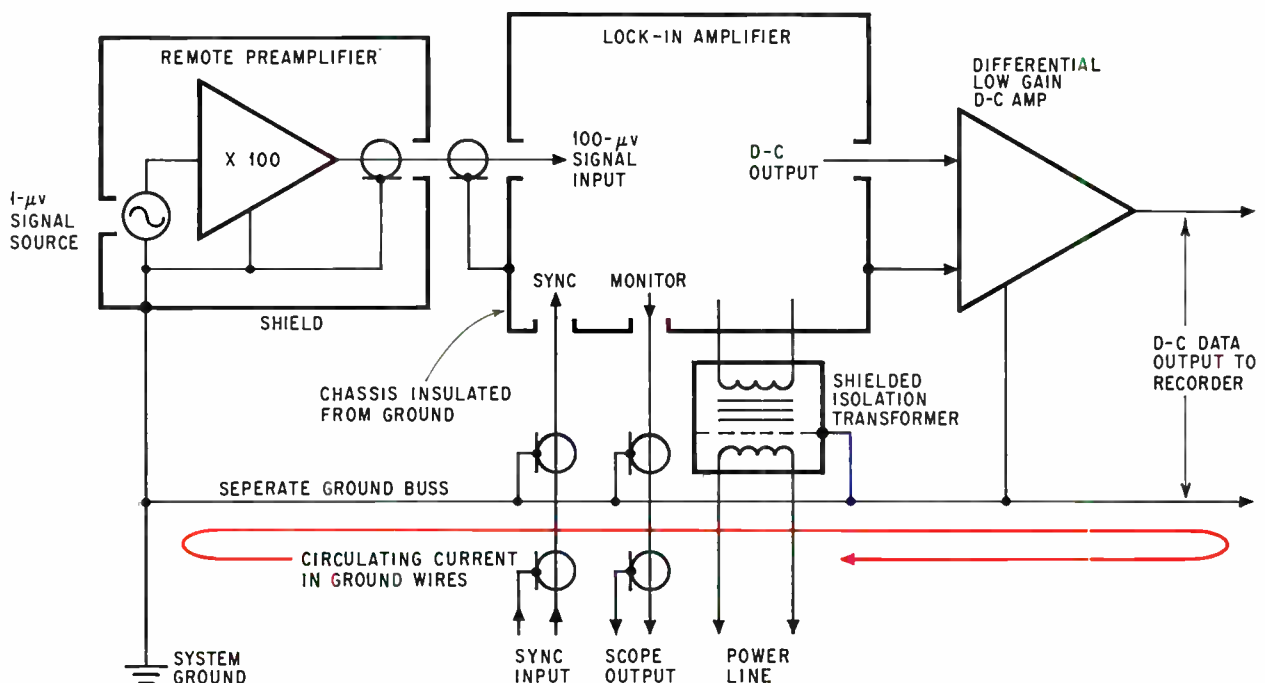

Isolation. By grounding and shielding all the inputs and isolating the main chassis output circuit, ground-loop currents are prevented.

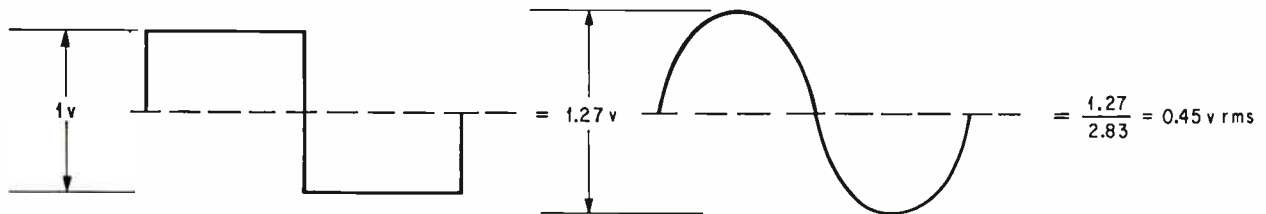

Waveform comparison. Fundamental sine-wave component of a square wave is larger than the square wave.

sive noise and errors are most likely to be introduced at the detector or preamplifier. Differential input amplifiers have been used extensively in an effort to eliminate these problems, but they are only partially successful.

In one scheme, a $1\text{-}\mu\text{V}$ signal source is grounded and connected to the differential input amplifier by means of a shielded pair cable. The chassis of the amplifier is also grounded, and any potential difference between the two grounds causes a current flow in the shielded cable between detector and preamplifier. This produces an error voltage, which is usually in the millivolt range.

If only 1 mv is assumed for the error voltage, the amplifier must have at least 1000:1 common-mode rejection to give less than full-scale error on the $1\text{-}\mu\text{V}$ range. It must have 100,000:1 or 100-db rejection to guarantee 1% measurement accuracy. This is virtually impossible to maintain with a differential balance control. Furthermore, the system now has the noise level increased because two identical input amplifiers are required instead of one.

Stray capacity problems

If the signal source is disconnected from ground to eliminate these ground-loop problems, stray capacities result that introduce unbalanced error volt-

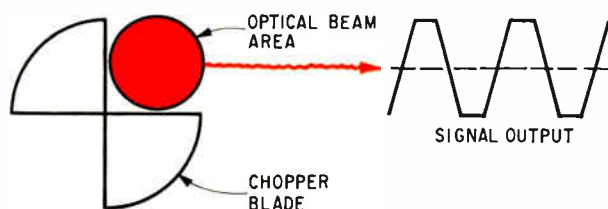

Signal chopper. Inserting a thermocouple in a system whose optical beam is larger than the chopper aperture results in a trapezoidal signal.

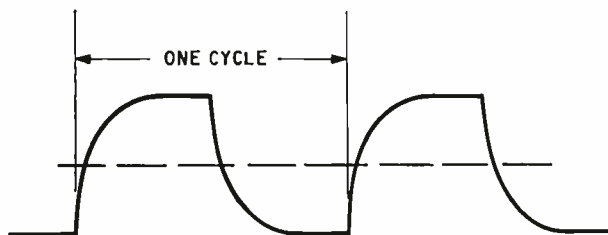

Charging signal. Shunting a high-resistance signal by stray capacitance produces an exponential waveform.

ages into the two amplifier inputs. Therefore, the common-mode rejection is a function of frequency, and only very low-frequency error voltages can be minimized with this technique.

If the circulating ground loop is broken by disconnecting the amplifier from ground, the results are even less successful, since the main power transformer has a large interwiring capacity to the power line—and the power line is always grounded. Furthermore, connection of an external data recorder, oscilloscope, or trigger in-out cables again causes ground-loop currents to flow.

Common-mode problems can be circumvented by grounding and isolating the main chassis output circuits. Differential input amplifiers can't maintain adequate common-mode rejection with nanovolt signals. In addition, a high-gain single-ended input amplifier is needed at the signal source to amplify the weak signal.

The circulating ground currents in this type of scheme flow through a separate ground bus rather than the signal-ground wires. This arrangement gives three main advantages:

- The differential preamplifier is no longer necessary, enabling a reduction of the input noise level.
- Common-mode error signals in the ground bus can be rejected by a factor of more than 1,000,000 times—without requiring a balance adjustment.
- All leads of the oscilloscope and data recorder are referred to the system ground rather than the output ground of the lock-in voltmeter. Thus, any connection can be made without affecting measurement of the signal.

Calibrating the system

When making measurements of low microvolt or nanovolt signals with a lock-in voltmeter, many sources of error are possible, such as an adjacent synchronous magnetic field, improper grounding techniques, and strong r-f interference. Unfortunately, these errors are often difficult to detect, since the signal levels are well below the range of most laboratory oscilloscopes or other test equipment.

The best method of evaluating system performance and accuracy is to substitute a known signal at the input terminals for the true signal. Because errors become increasingly pronounced in the more sensitive ranges, the calibration signal must be applied on all ranges of the instrument.

If the calibration square-wave source is grounded to the main chassis of the instrument, the calibration procedure isn't likely to be reliable at very low

signal levels. This is because the synchronous voltage difference between the signal input and main chassis grounds is an appreciable part of the calibrator voltage. For example, it is easily possible to obtain an error of $10 \mu\text{v}$ or more across the face of an instrument from one connector to another.

The error can't be detected by connecting the preamplifier input to the calibrator output and then switching the calibrator off, because the calibrator may produce the ground-error current. This shows up as a percentage error, not a zero drift. If an instrument must be calibrated under these conditions, the preamplifier should be disconnected from the signal source and all grounds, then connected through a short cable to the calibration source.

If a remote preamplifier is used, the problem is even more severe. In such a case one must use a separate calibration source that isn't grounded anywhere except at the preamplifier input terminals.

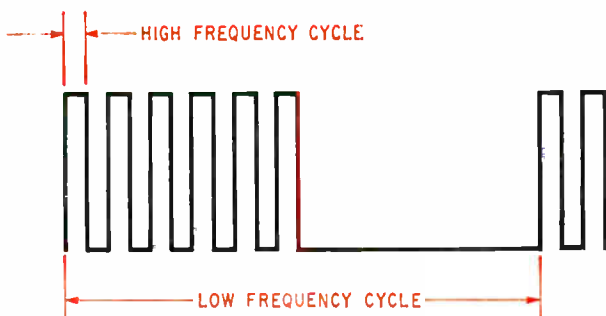

Recovery. A lock-in voltmeter can recover either a high or low frequency, but indicates only half of the true energy.

This arrangement avoids errors by preventing the calibration ground currents from flowing in the signal ground leads.

The synchronous rectifier-output filter combination of the lock-in voltmeter recovers only the fundamental component of the signal and, to a lesser extent, the odd harmonics. This is true regardless of the signal waveform, especially because a tuned signal amplifier is usually put in the instrument to help reduce the system bandwidth.

The energy of the fundamental component isn't the same for different waveforms even if they have the same peak-to-peak amplitude. Therefore, it is necessary to take this factor into consideration in calibrating a system's sensitivity. The least error is obtained when the calibration and signal waveforms are similar.

Choosing a waveform

Signal waveforms from photodetectors are frequently square or trapezoidal waves, because it's easier to turn the radiant energy source completely off and on than to provide linear modulation. To calibrate a photometric instrument, therefore, a peak-to-peak square wave is much better than an rms sine wave.

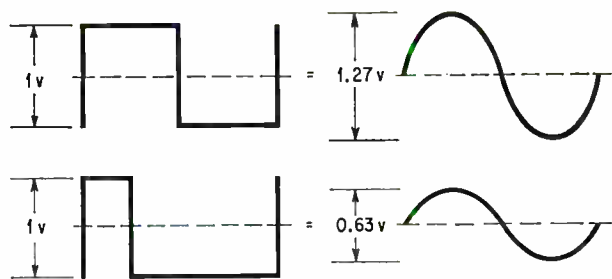

Averaging. The instrument averages the energy of the signal regardless of its shape.

Because the fundamental sine-wave component of a square wave is larger than the square wave itself, the signal waveform is very important in cases of absolute energy measurement with a calibrated thermocouple. The thermocouple is illuminated with radiant energy that's cut off and turned on sharply, and its output is calibrated against an accurate square-wave voltage. If the thermocouple is used in a system whose optical beam is bigger than the chopper aperture, a trapezoidal signal waveform results. It has a different fundamental component than a square wave with the same peak-to-peak amplitude, and this difference causes a serious measurement error, on the low side.

When a signal detector is used to recover a frequency higher than its response time permits, or when a high resistance signal source is shunted by stray or cable capacity, the signal waveform at the bottom of page 86 results. A loss of energy again occurs, and the detector sensitivity has been changed. Thus, it must be calibrated under these conditions if it's to be used to measure radiant energy in absolute units.

The on-off duty cycle of the signal also determines its energy content at the fundamental frequency to which the instrument is tuned. A square wave provides maximum signal strength for a given amplitude, but the instrument averages the energy in any repetitive signal.

As the square-wave duty cycle to the area becomes unsymmetrical, the signal energy declines in direct proportion. It's important, therefore, to provide a stable duty cycle in the generator that produces the signal waveform, or otherwise the jitter in

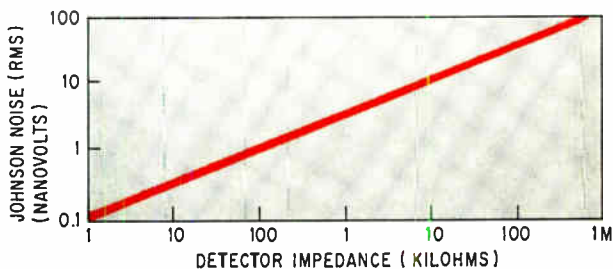

Noise threshold. Typical value of Johnson noise is plotted for a given detector as a function of detector impedance. The choice of operating frequency is arbitrary, as long as the system has a 1-hertz bandwidth.

Calculating the effects of random noise

The following four-step procedure can be used to analyze the effects of random noise on a synchronous system:

Step 1. Connect a square-wave oscillator with exactly 1-volt peak-to-peak amplitude to both the signal and sync inputs of a lock-in voltmeter. The controls for frequency, phase, and gain must be adjusted on the lock-in voltmeter so the center-zero meter deflects full-scale in the positive direction—with the meter calibrated to indicate 1 volt. Examination of the Fourier series for the 1-volt peak-to-peak square-wave input shows that the fundamental sine-wave component is 1.27 volts peak-to-peak. Therefore: 1.27-volt peak-to-peak sine-wave input = 1-volt output.

Step 2. Disconnect the sync input and switch the lock-in voltmeter reference channel to its own internal oscillator. The meter now swings back and forth slowly from positive to negative full-scale. This is because of loss of synchronization and a resultant beating between the internal and external oscillators. Under this condition, the internal oscillator of the voltmeter establishes the signal frequency, and the external oscillator becomes a steady-state noise generator—since any frequency not synchronous with the signal is considered to be noise. Therefore:

1.27-volt peak-to-peak steady-state noise = ± 1 -volt or 2-volt peak-to-peak output. This artificial steady-state noise doesn't produce a steady meter reading on a lock-in voltmeter.

Step 3. Since true noise has random variations, it produces additional fluctuations of the meter

over a period of time. The amplitude distribution of Gaussian noise is such that for 99% of the time, the true rms value is 1/5 of the maximum peak-to-peak value. Therefore, if the steady-state noise is replaced by a random-noise generator, then $\frac{1.27 \text{ v p-p}}{5}$

$$= 0.26 \text{ v rms random noise} \\ = 2 \text{ v maximum p-p output}$$

Step 4. Therefore, for a system calibrated in terms of a square wave peak-to-peak, the true rms input noise is 1/8 of the measured peak-to-peak output noise level.

If the instrument is calibrated in rms values instead, an additional correction factor of 0.45 rms, sine-wave, to 1-volt peak-to-peak square wave, must be applied. Therefore, for a system calibrated in terms of a sine-wave rms, the true rms input noise is 2/7 of the measured peak-to-peak output noise level.

Bandwidth. With the voltmeter slowly drifting from full-scale positive to full-scale negative as in step 2, the engineer selects a single section output filter with a 1-second RC time constant. Changing the frequency of the external oscillator very slightly in either direction causes the meter beating to become more rapid and the amplitude to decline. The effect may be plotted for a 10-hertz center frequency as shown on page 89. The conventional curve of a tuned amplifier is produced; the system bandwidth may be measured as the frequency difference between 70.7% points. In this case, the difference is ± 0.16 hz or 0.32 total bandwidth.

The half-power bandwidth that

was just derived, however, isn't the same as the true noise bandwidth, which is represented by the total area under the curve. This is, by definition, 1.57 times the bandwidth of the conventional curve. A 1-second, single-section, RC time constant produces an equivalent noise bandwidth of 0.5 hz, so:

$$\text{Equivalent noise bandwidth} = \frac{1}{2RC}$$

Risetime. Reconnect the square-wave oscillator to the sync input of the voltmeter, and adjust the controls for full-scale meter deflection, as in step 1. Alternately short-circuit the signal input and then reconnect it to the oscillator. The d-c output may now be plotted during the signal off-on conditions, see bottom right-hand drawing on page 89.

A single 1-second RC filter, curve A, gives a 10% to 90% rise time of two seconds. Substituting a double 0.7-second RC filter, curve B, gives the same 10% to 90% rise time, but has the advantage of reaching the 99% point faster than the single filter. A second advantage of the double filter is its improved reduction of high-frequency noise in the output.

From these values, the following approximations may be made:

Single-section filter
10 to 90% rise time = 2.2RC

$$\text{Noise bandwidth} = \frac{1}{2RC}$$

Double-section filter
10 to 90% rise time $\cong 3.4RC$

$$\text{Noise bandwidth} \cong \frac{1}{4RC}$$

pulse width produces noise and error in the output.

Choosing a preamp

When the background noise becomes 100 times or more greater than the signal, a preamplifier with extreme linearity and overload capability must be used so the highly amplified noise peaks can be averaged without introducing errors caused by driving the amplifier into its nonlinear region.

For other applications, the signal may be a millivolt or more obscured by noise. Here, the high-gain preamplifier is advantageous because the tuned main signal amplifiers can now accept the noisy signal directly—with the least noise overload.

Usually, the preamplifier has a much wider bandwidth than the tuned signal amplifiers in the main instrument. It is possible, therefore, to overload the preamplifier on thumps or high-frequency spikes. This can drive it into a nonlinear region without any visual indication from the meter, oscilloscope monitor jacks, or overload light of the main instrument, because these all monitor the signal waveform only after it has passed through the tuned amplifiers, and the distortion is no longer obvious. To prevent this error, the preamplifier bandwidth must be restricted as much as possible around the signal frequency, and the preamplifier output level should always be monitored on an oscilloscope.

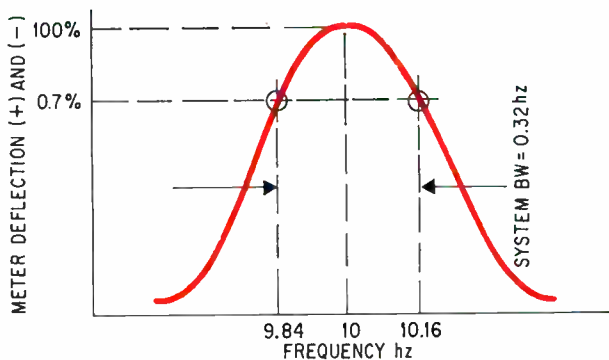

System bandwidth. Bandwidth for output response is found by measuring the width of the curve at the 70.7% values; for this curve, the bandwidth is 0.32 hz.

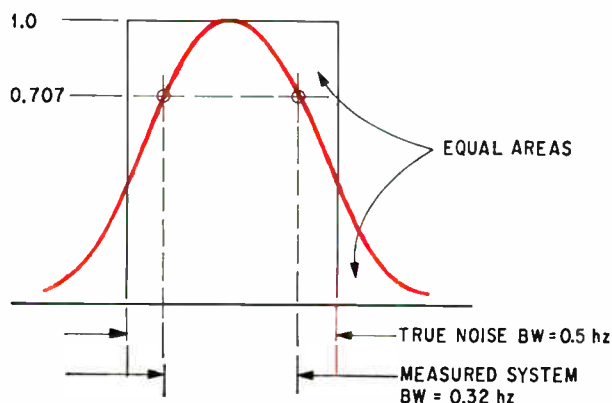

Equivalent noise bandwidth. By definition, true noise bandwidth is 1.57 times the measured bandwidth. In this case, the measured bandwidth is 0.32 hz, so the noise is 0.5 hz.

$$\text{Equivalent noise bandwidth}_{(hz)} \cong \frac{1}{10 \text{ to } 90\% \text{ rise time}_{(sec)}}$$

Regardless of the output filter used,

Tuned amp. The voltmeter usually has a tuned signal amplifier, and this provides an additional reduction in the bandwidth of the

instrument and increases the rise-time. Therefore, the measured values of rise time and bandwidth won't agree with the theoretical values derived from the filter RC time constants unless the tuned amplifier has a relatively low Q or the filter time constant is longer than the frequency of oper-

ation. For a typical system in which signal amplifier $Q \leq 15$

$$\text{Rise time}_{(sec)} \leq \frac{20}{\text{Frequency (hz)}}$$

The over-all system bandwidth can always be determined by measuring the actual rise time and applying the rise-time formula.

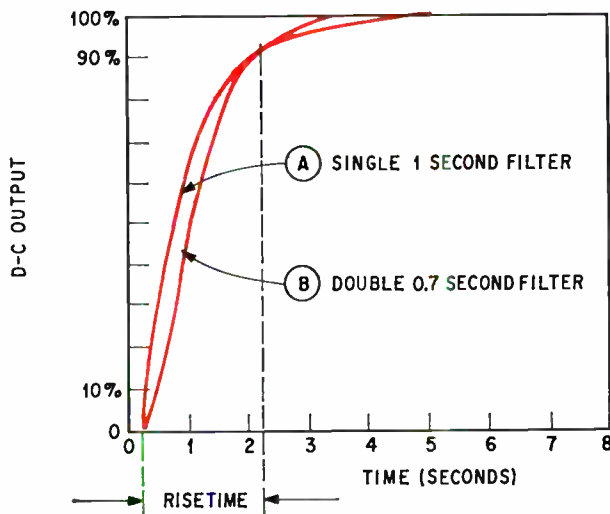
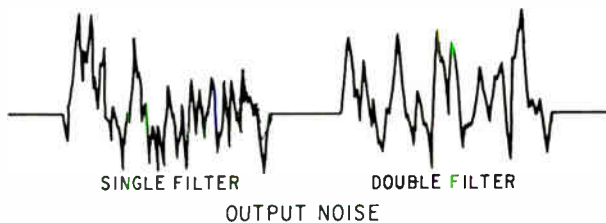

Rise-time measurement. Rise time of the d-c output response is the time it takes the curve to go from 10% to 90% of its maximum value. Rise time is the same for both filters, but the double-filter section reaches the 99% point faster than the single-filter section.

The dominant noise source can usually be identified by examining the output of the relatively wide-band preamplifier on an oscilloscope. To make sure that the lock-in voltmeter works properly, one should block the radiation of the detector and check for an accurate zero level. In particular, the phasing controls should be rotated to verify that they don't affect the output level without an input signal.

The number of on-off signal cycles that may be averaged over a period of time has a direct effect on noise reduction. As a result, a compromise must always be reached between the amount of noise that can be tolerated and the time available to make the measurement. For certain applications, a high-speed

response is the main requirement, and this limitation established the minimum signal-to-noise ratio. In either case:

$$\text{Output noise} = \frac{K}{\text{Rise time}}$$

Thus, the response time must be increased 100 times to improve the signal-to-noise ratio 10 times.

A quick check

Because the minimum noise level can never be less than the Johnson noise of the detector, system performance can be checked quickly by measuring the actual input noise level and comparing this with

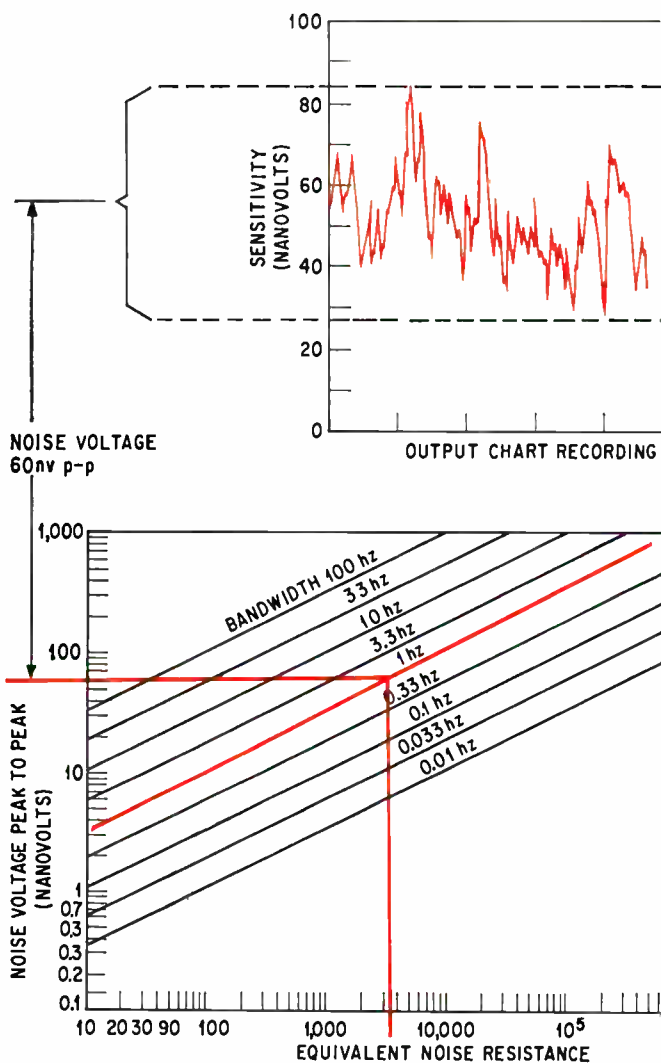

Example. Designer plots a 3-kilohm noise resistance and reads the value of noise voltage obtained where this line intersects 1 hertz. In this example, the value is 60 nanovolts. Then he checks the peak-to-peak value of the output chart to be sure that the value doesn't exceed 60 nanovolts.

the theoretical value for the detector Johnson noise.

The plot of Johnson noise, in nanovolts, that may be expected from a given detector at room temperature appears at the bottom of page 87. It doesn't matter what operating frequency is chosen, provided that the system always has a 1-hertz bandwidth. Thus, a 100-ohm detector, for example, will give approximately 1.3 nv rms noise in an ideal system.

However, measurement of the actual system noise level is more difficult than it appears, because most instruments aren't calibrated in noise bandwidth. This parameter must usually be determined for the system to be tested, and the input noise will appear as random fluctuations of the output. These fluctuations can be related to the Johnson-noise plot only if the correct conversion factor is known.

If the effects of random noise on a lock-in system are analyzed, however, a simple technique may be devised for determining both the system bandwidth

and a measurement of the noise level in terms of its peak-to-peak rather than rms value. This procedure is described on page 88.

The equivalent noise bandwidth may be measured in any system regardless of the type of tuned signal amplifiers or output RC filter used. This is done by keying a full scale signal on and off to determine the time required for 10% to 90% rise time to occur.

Determining noise bandwidth

Once a chart is developed for the system bandwidth in terms of peak-to-peak values, the following four-step procedure can be used to determine the minimum noise voltage:

Step 1. Switch the system gain to low sensitivity to reduce the noise level. Alternately remove and reapply a strong signal to measure the over-all system 10% to 90% rise time. If possible, select an RC time constant to give a one-second rise time, since this results in a one-cycle bandwidth—the standard specification for most detectors, amplifiers, or components.

Step 2. Block the signal to the detector and increase the system gain until the peak-to-peak noise level can be measured over a period of about one minute. Use progressively longer measurement times with rise times of less than a second.

Step 3. Check the system sensitivity to calibrate the output noise level in terms of noise voltage (peak-to-peak) at the detector.

Step 4. Plot the insertion of the measured noise voltage and bandwidth on the appropriate chart to obtain the value of equivalent noise resistance at the input for comparison with the actual detector impedance.

Illustrating the point

The ease of this procedure can be demonstrated by the following example: the instrument is considered to be noise-free and the input load is a 3-kilohm resistor. Using the peak-to-peak voltage curve, the designer enters the load and reads the noise voltage where the load line intersects the 1-hz line; in this case, the reading is 60 nanovolts. Then he checks the output plot to make sure that the peak-to-peak voltage doesn't exceed 60 nv.

If the detector is cooler than room temperature, it will have considerably less Johnson noise for a given impedance. The correction factor is:

$$\text{equivalent noise resistance} = \frac{\text{detector temperature } (^{\circ}\text{K})}{297^{\circ}\text{K}} \times \text{detector impedance}$$

Thus, if the detector were 3,000 ohms at a temperature of 4°K, its equivalent noise resistance would decline to:

$$(3,000) \frac{4^{\circ}\text{K}}{297^{\circ}\text{K}} = 40 \text{ ohms}$$

The measured noise voltage, therefore, should be reduced from the original 60 nv to about 8 nv peak-to-peak.

Designer's casebook

Voltage comparator is made with op amps and logic gates

By Walter Ellermeyer

U.S. Navy Electronics Laboratory, San Diego

A comparator for a voltmeter's automatic ranging circuits can be made with readily available logic circuits and operational amplifiers instead of the usual transistors and diodes. Using gates and op amps makes the comparator much easier to wire together. A feedback circuit to make the op amp a switch is also simple to assemble.

The two voltage limits of such a "high-go-low" comparator are independently adjustable. When an input voltage is applied to the circuit, one output will indicate whether the input is above the upper limit, another will indicate whether the input is between the limits, and a third will indicate whether it is below the lower limit.

The limits may be both positive, both negative, or one positive and the other negative. Because

the outputs are unipolar, high-speed relays and logic circuitry can be used.

If the input is 5.1 volts and the wiper of potentiometer R_1 is set at the middle of its range, a positive 0.05 volt will appear at the negative input of op amp O_1 . Because the op amp is in an inverting configuration, its output is a negative voltage. This negative voltage must attain a magnitude of 10 to cause avalanche in the zener, thus holding the negative input at zero volts. The -10 volts are also coupled out to a relay to turn on the high-voltage meter. Another inversion takes place in inverter I_1 , and a zero voltage is presented to the AND gate.

The same process takes place in the lower half of the circuit. The zero voltage from the output of the inverter keeps the relay in the low-voltage meter circuit inactive, and the AND gate's zero-voltage output keeps the relay in the intermediate-voltage meter inoperative.

When the input falls below 5 volts, the wiper of R_1 has a negative voltage that makes O_1 generate a positive output voltage. However, this output never gets above 0.8 volt, because zener D_1 becomes forward-biased at this point, and current is

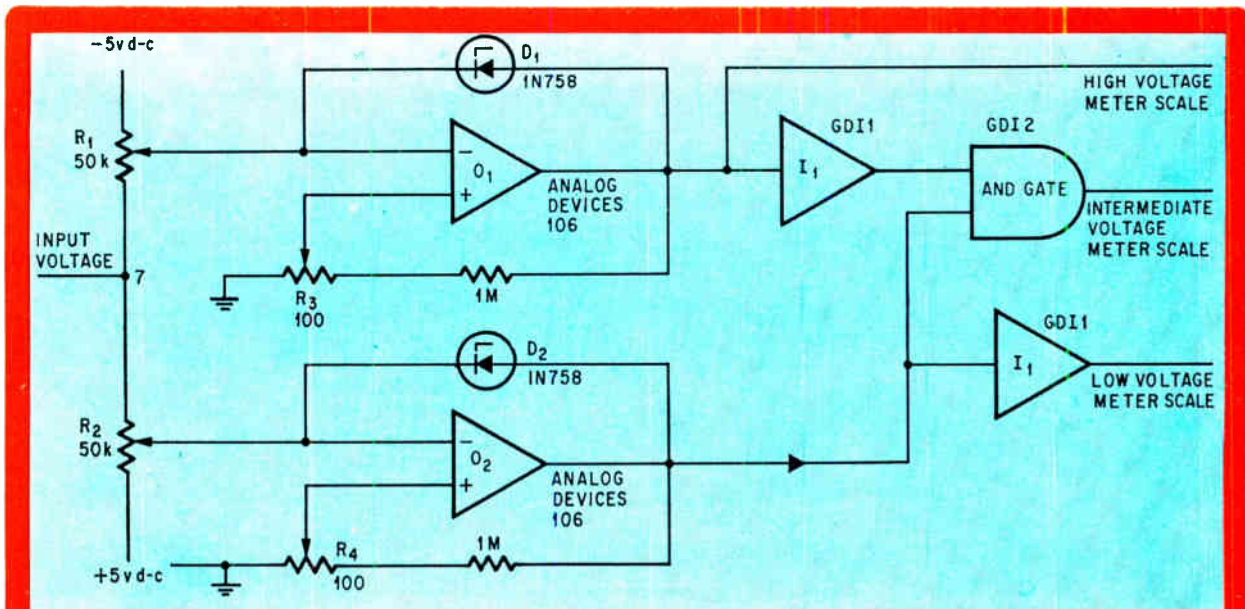

Comparison and assignment. Operational amplifiers control the selection of meter scales in an automatic voltmeter. Zener diodes are used as the op amps' feedback loops thus they operate as switches. The potentiometers R_1 and R_2 determine what input level causes the op amps to switch

drawn through it. This holds the negative input of the op amp down to a voltage close to zero—the desired condition when an op amp is used for switching. Obviously, the 0.8 volt at the output of O_1 can't energize the relay in the high-voltage meter circuit.

The 0.8 volt is inverted in the AND/OR gate I_1 , and so -10 volts are presented to an input of the AND gate. The output of O_2 has placed -10 volts at the gate's other input. These two inputs make the output of the AND gate -10 volts, and the relay in the intermediate-voltage meter system is energized. After inversion by I_2 , the -10 volts at the output of O_2 becomes zero volts, thus preventing the relay in the low-voltage meter system from being energized.

There is a -10 volts at the output of O_2 , because a positive voltage at the input is inverted in the op amp.

An input voltage that's more negative than the -5 volt supply makes the output of both op amps zero. This keeps the high-voltage meter circuit out of operation, places two different voltages — -10 volts and zero volts — at the input of the AND gate, and makes inverter I_2 generate a zero output voltage. The two different inputs to the AND gate result in a zero output voltage and an inoperative intermediate-voltage meter circuit.

Resistors R_3 and R_4 provide hysteresis to the op amp to prevent any noise from triggering the circuit when the input voltage is close to either the supply voltages.

Transistor and zener protect series regulator

By Bob Phillips

Motorola Semiconductor Products, Phoenix, Ariz.

Before it blows the fuse in a power supply, a short in the load circuit usually has enough time to destroy the supply's regulating transistor. This can be avoided, though, by adding a responsive pro-

tection circuit to the regulator. Not only will this circuit prevent destruction of the regulator, but it will automatically return the regulator and the power supply to normal operation when the short is removed.

A short circuit in the output causes all the supply voltage to appear across zener D_1 , the decibel R_2 , and the emitter-base junction of Q_2 . Since the input supply voltage is greater than the zener breakdown voltage of D_1 , the diode draws reverse current and supplies base drive to Q_2 . As Q_2 approaches saturation, it robs Q_1 of base drive and cuts that series pass transistor off.

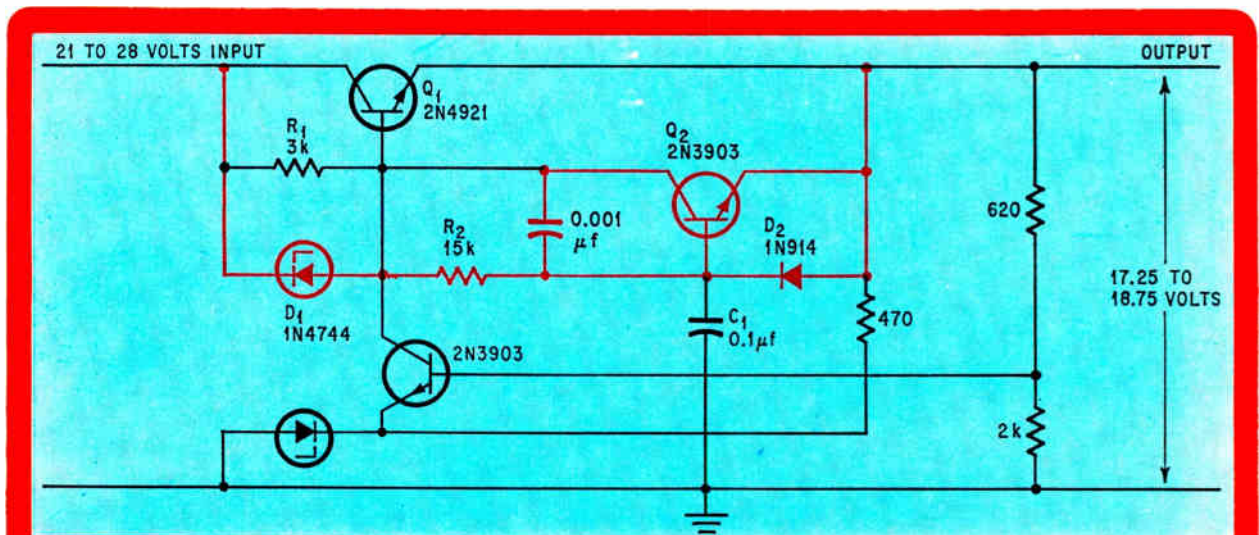

Sidetracked. When output load resistance drops from nominal 360 ohms to a short, zener D_1 starts conducting. This causes Q_2 to conduct and shorts out Q_1 's base-emitter junction. The zener's high reverse resistance and R_2 limit the load current until the short is removed.

Capacitor C_1 , which was charged up to the output voltage before the short appeared then aids in turning Q_2 on by discharging through the transistor's base. Although C_1 discharges to a very low voltage when the regulator is in a short-circuited mode, Q_2 remains in saturation because of D_1 's zener current.

The series pass portion of the circuit is conventional in operation and is designed so that its presents an output impedance of 200 milliohms to the load when supplying 50 milliamperes.

When the short is removed, the voltage across the output begins to rise due to the current that flows through R_1 and the saturated Q_2 . Since the base of Q_2 is held to a low voltage by C_1 and the emitter voltage is rising, the V_{BE} of Q_2 drops, causing this transistor to begin to turn off. Since the current through R_1 is essentially constant and the current through transistor Q_2 has decreased, some current is shunted into the base of Q_1 , caus-

ing this transistor to begin to turn on.

As transistor Q_1 supplies current to the load, the voltage across the output increases even more. This action eventually causes the reverse biasing of Q_2 , turning it off completely.

With Q_2 off, normal control current is supplied to the base of Q_1 and the circuit resumes normal operation. Diode D_2 prevents the emitter-base junction of Q_2 from breaking over when the short across the output is removed.

Capacitor C_2 enhances the a-c stability of Q_2 but may not be necessary in all circuits.

The response of the protection circuit is limited by the storage and fall time of Q_1 . For the devices and load conditions shown, it operates in approximately 1 microsecond.

When the power supply is operating into its nominal load—36 ohms—the protection circuit is biased off and in no way affects the regulation. The zener D_1 is a high resistance and Q_2 is cut-off.

Diodes in a multivibrator lesson frequency variations

By James Teixeira

Sylvania Electronic Systems, Waltham, Mass.

The **astable multivibrator** is an excellent source of square waves—it's inexpensive to build and can be easily designed for operation over a wide frequency range. Unfortunately, because its frequency is sensitive to changes in temperature, it can't be used in applications where marked environmental changes are encountered. Compensating diodes added to the multivibrator, however, will nullify those transistor changes that cause frequency shifts. These diodes costs much less than the LC oscillators and clipping circuits usually used as frequency sources where marked temperature changes are encountered.

Half of the multivibrator's period—the width of one of the square waves—is related to the transistor and supply voltages by

$$t = RC \ln \left[\frac{V_C + V_B - V_{be} - V_{ce(sat)}}{V_B - V_{be}} \right]$$

where t = half the multivibrator's period of oscillation

R = 30.9-kilohm base resistor

C = 0.01-microfarad coupling capacitor

V_C = transistor collector voltage

V_B = transistor base voltage

V_{be} = base-to-emitter voltage across the transistor

$V_{ce(sat)}$ = collector-to-emitter saturation voltage of the transistor

This equation is valid only if the transistors have high gain and low reverse leakage current. Because the transistors aren't operated at their upper limit of gain, temperature changes won't affect the gain. And because the leakage current is so low, any changes induced in it by temperature will be infinitesimal. These two temperature-sensitive parameters can therefore be disregarded when the multivibrator is subjected to temperature variations. The use of metal-film resistors and mica capacitors—components whose values don't change with temperature—keeps the values of R and C constant.

Differentiating the equation with respect to temperature and then writing it in differential form results in the following

$$\left[dt = RC \frac{V_B - V_{be}}{V_C + V_B - V_{be} - V_{ce(sat)}} \right]$$

$$[(V_B - V_{be})(dV_C + dV_B - dV_{be} - dV_{ce(sat)}) - (V_C + V_B - V_{be} - V_{ce(sat)})(dV_B - dV_{be})]$$

A squared term in the denominator has been re-

moved; because the numerator is eventually set equal to zero.

Because the difference between V_B and V_C is the negligible forward drop of the diodes D_1 and D_2 and because V_{be} and $V_{ce(sat)}$ are smaller than V_C , the first bracket in the above equation

$$\frac{V_B - V_{be}}{V_C + V_B - V_{be} - V_{ce(sat)}}$$

can be rewritten as

$$\frac{V_B}{2V_B} = \frac{1}{2}$$

By eliminating all the V_{be} and $V_{ce(sat)}$ terms and making all V_C terms equal to V_B , the second bracket in the equation becomes

$$[V_B(dV_C + dV_B - dV_{be} - dV_{ce(sat)}) - 2V_B(dV_B - dV_{be})]$$

After multiplication and transposition, it takes the form

$$[V_B dV_C + V_B dV_B - V_B dV_{be} - V_B dV_{ce(sat)} - 2V_B dV_B + 2V_B dV_{be}]$$

When like terms in this bracket are subtracted and

the bracket is then recombined with the first, the differential equation becomes

$$dt = \frac{R_1 C_1}{2} dV_C - dV_B + dV_{be} - dV_{ce(sat)}$$

Replacing dt with zero mathematically expresses what happens when the multivibrator's frequency doesn't change. All the terms that indicate the change in supply voltages are moved to the left of the equals sign, and those that indicate transistor voltage changes are kept on the right. This equation

$$dV_B - dV_C = dV_{be} - dV_{ce(sat)}$$

shows which voltages compensate for temperature changes in the multivibrator.

In a transistor, dV_{be} is usually $-2\text{mv}/^\circ\text{C}$ and $dV_{ce(sat)}$ 0.2mv . This total change of $-2.2\text{mv}/^\circ\text{C}$ in the voltages on the right-hand side of the equation doesn't affect circuit operation because there is a $3\text{mv}/^\circ\text{C}$ change in the supply voltages on the left side. Because of the way the diodes are placed in the circuit, dV_B is $1\text{mv}/^\circ\text{C}$ and dV_C is $2\text{mv}/^\circ\text{C}$, giving the total of $3\text{mv}/^\circ\text{C}$. Over the temperature range from -10° to 90°C , a 1-megahertz multivibrator will have a frequency shift of only 10 hertz.

Of course a highly stable power supply should be used with the compensated multivibrator.

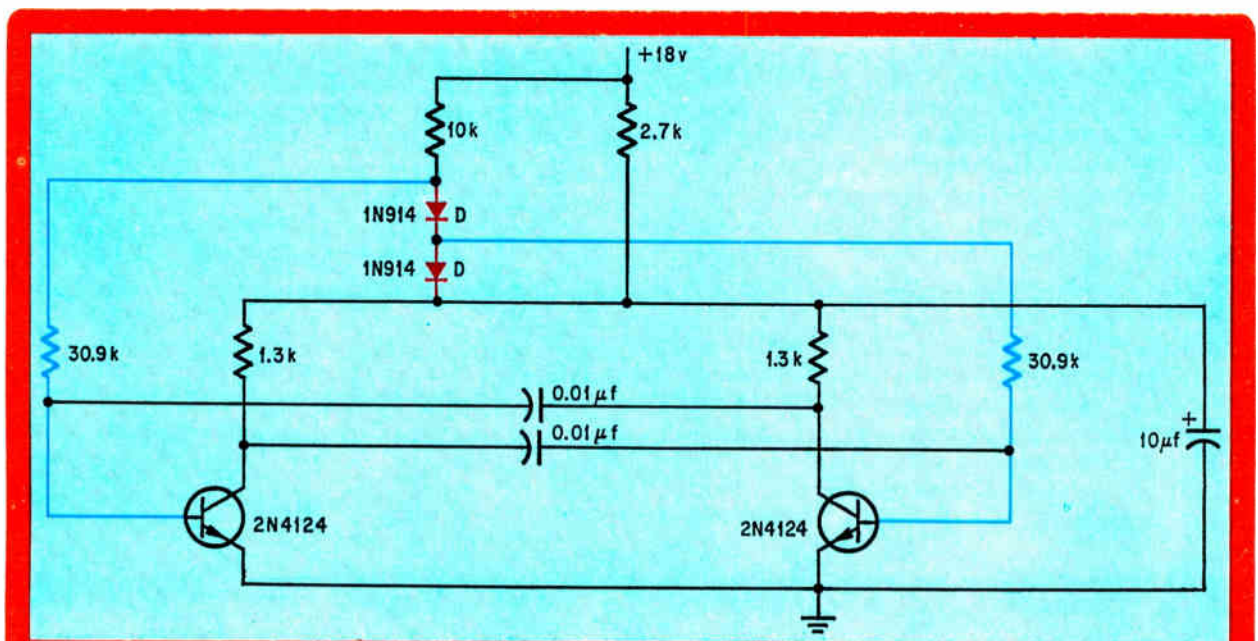

Straight and narrow. Those changes in transistor characteristics that cause the multivibrator frequency circuit to shift are nullified by diodes D_1 and D_2 . The changes in the forward drops of the diodes are nearly the changes in the base-emitter and collector-emitter voltages in the transistors.

If all the information contained in our Silicon Package Qualification Report were printed in type this size, it would more than fill this page. We have enough reliability data to convince anyone that our silicon-pack IC's qualify for full military use. If you write to us, we'll send you all the facts in nice, readable type. Signetics Corporation, 811 E. Arques Ave., Sunnyvale, Calif. 94086. A subsidiary of Corning Glass Works.

Fabrication advances boost potential of avalanche diodes

Improved methods of heat sinking and new techniques for creating abrupt junctions make the devices strong contenders for applications as power sources in the microwave range and broadband noise generators

By Harry L. Stover

Texas Instruments Incorporated, Dallas

Design techniques that allow avalanche diodes to dissipate heat faster are boosting the devices' power levels and suiting them to some new microwave applications. However, the technology has a long way to go and only few companies have successfully applied these methods.

Avalanche diodes are operating at power densities of 10^6 watts per square centimeter, a figure unprecedented in semiconductor device history. A typical diode must dissipate tens of watts of heat to perform well at such levels.

It's not surprising then that the most important advance in the field has been the flip chip, a design in which the junction side of the diode is bonded to a metal heat sink. This configuration permits heat generated at the junction to flow directly to the sink instead of through the thick semiconductor substrate.

With the employment of this and other techniques, including several for the paralleling of diodes and the control of diffusion profiles, avalanche devices can now generate up to 4.7 watts of continuous-wave power at 13 gigahertz with 6% to 8% efficiency. Noise performance has also improved because as current increases, avalanche noise decreases.

To date, germanium diodes have delivered the best noise performance—28 decibels at 6 GHz, for example, when used in a reflection amplifier. Silicon diodes are about 10 db noisier, though this disadvantage is offset by the fact that silicon is a better heat conductor and is easier to reproduce. The noise performance of gallium-arsenide diodes is expected to be at least as good as that of germanium, but experimental data is too sparse as yet

for meaningful comparisons to be made.

The linewidth of avalanche-diode oscillators has been narrowed and noise sidebands close to the carrier have been suppressed by injection locking the devices to a quiet source, such as a crystal-controlled oscillator-multiplier chain. Flip chipping also improves linewidth because it lowers the diode's thermal resistance, cutting down on low-frequency noise. This kind of noise causes the most trouble in amplifiers and oscillators because it modulates the negative resistance and susceptance, introducing frequency-modulated noise into the microwave output signal.

Potential low-noise applications for avalanche diodes include use in linear negative-resistance reflection amplifiers, as local oscillators, and—when injection locked—in frequency- and phase-modulation amplifiers. On the other side of the coin, these diodes should also find widespread use as secondary noise standards. Not only are they smaller and more reliable than gas discharge tubes, but when operated at low currents they put out more noise over a broader band of microwave frequencies.

Although avalanche diodes are designed to perform at a particular frequency, they can be operated over very wide ranges. A diode designed for X band, for instance, can operate from C to Ku band.

Vital region

Very little improvement has been made in the original avalanche diode, a four-layer device called the Read diode. Potentially the best of the breed, it unfortunately is also the most difficult to fabricate. Most of the progress has been made with a



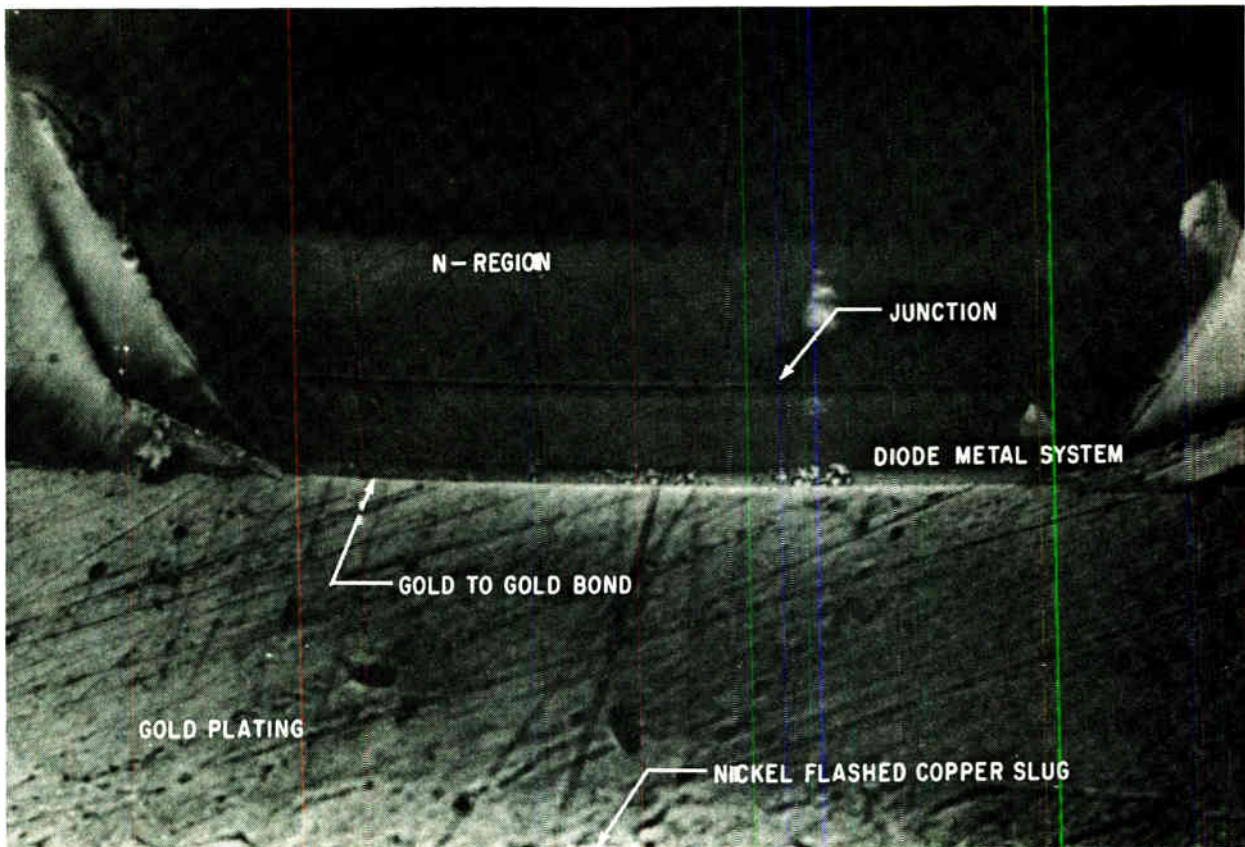

Flip chip. Bonding the junction side of avalanche diode to heat sink has given biggest boost to performance.

three-layer mesa design, the $p^+n^-n^+$ diode.

The operation of both these structures is similar in that they develop a negative resistance caused by a 90° phase lag between the electric field and the avalanche-generated current and a 90° phase shift between the voltage and external current. The transit time of carriers across the drift region causes the latter phase shift [see "Time to start an avalanche", p. 98].

Primary design parameters for a three-layer diode are thickness and doping of the n^- region and size of the cross-sectional area of the junction.

The n^- region's thickness determines the mid-band oscillation frequency. Thickness should be such that carriers travel across it in half a cycle. The region's doping is the major factor in the device's efficiency and should be of a level sufficient to cause full depletion near avalanche breakdown.

Diode power, thermal capacity, and impedance depend on the size of the junction area. The larger the area, the greater the power and the lower the impedance. However, the ability to dissipate heat doesn't increase with the junction area but rather with the junction diameter, provided the diode is designed for minimal thermal spreading resistance. That is, heat must be dissipated radially as well as straight down. It's therefore preferable to mount several small diodes far apart rather than placing a single large diode on a heat sink.

These rule-of-thumb considerations in regard to doping and thickness hinge on having abrupt p^+n^- and n^-n^+ interfaces and a uniform n^- region, con-

ditions rarely found in actual diodes because of the nature of the fabrication processes used.

Most common is the diffusion approach in which the n^- epitaxial layer is doped with boron to form the p^+ region. During the time the diode is held at the required high temperature for the boron diffusion, impurities in the n^+ substrate can diffuse into the epitaxial n^- layer. This moves the n^-n^+ interface away from the physical substrate-epitaxial interface, thereby shortening the n^- region and creating a nonuniform distribution of impurities in this region.

The resulting uneven or incomplete depletion hurts diode efficiency. Also, the distribution of the electric field in this kind of n^- region puts a higher voltage across the diode than would the field distribution in a region with an abrupt demarcation.

Specialized diffusion techniques have been developed to reduce these effects, but silicon diffused diodes nevertheless rarely approach the ideal. However, they've been around longer than other types and still offer the highest powers and efficiencies.

Sowing and growing

In attempting to solve the out-diffusion problem, R.S. Ying and R.W. Bowers, researchers at the Hughes Aircraft Corp., have abandoned the conventional fabrication process and have instead formed $p^+n^-n^+$ silicon diodes by implanting boron ions in an n^- epitaxial layer. This method, along with annealing, creates an abrupt p^+n^- junction because the temperatures required aren't high enough to

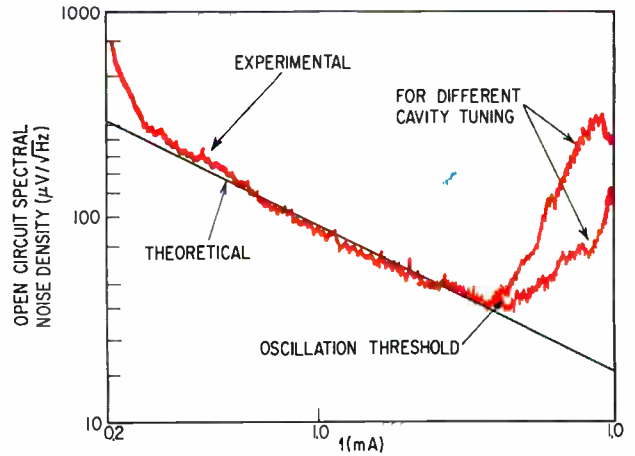
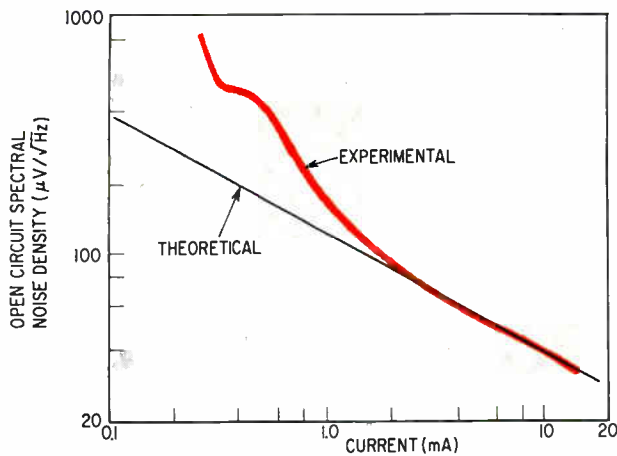

Regular curves. TI's double epitaxial diode (right) shows the uniformity of breakdown of guard ring diode.

cause impurities to diffuse out of the substrate.

Provided high-temperature fabrication steps—oxidation, for example—aren't taken afterwards, the n^-n^+ interface should be a sharp one. Because ion implantation is still a relatively new technique, the performance of diodes fabricated in this manner comes close to—but still hasn't reached—that of the best diffused avalanche devices.

The latest fabrication method, developed by H.M. Leady, the author, and E.A. Trantham of Texas Instruments, avoids the out-diffusion problem by growing n^- and p^+ epitaxial layers separately on a highly polished n^+ substrate at lower temperatures over a much shorter period of time. The ability to

precisely control epitaxial doping and thickness is an important advantage; doping profile measurements indicate very abrupt doping interfaces.

Diodes fabricated by this double epitaxial process thus consist of physically separate n and p layers, and this raised the possibility of crystal imperfections introduced during deposition. It was also feared that the p and n layers might etch differently during the fabrication of the mesa structure. Any defective area would break down before the rest of the junction, producing a nonuniform avalanche.

To determine whether this was so, researchers compared the noise-versus-current performance of a double epitaxial diode to that of a low-frequency

Time to start an avalanche

Basic to the performance of avalanche diodes is the negative resistance developed by phase shifts introduced by the avalanche process and by carrier transit time.

These diodes are reversed biased with a d-c voltage into junction breakdown. Once oscillations begin, the resonant circuit superimposes an a-c voltage across the diode. The electric field at the p-n junction is nominally in phase with the voltage across the diode except at very high currents.

When the field exceeds a threshold value, valence electrons are knocked into the conduction band, producing hole-electron pairs. Electrons and pairs then collide with surrounding atoms, generating more electron pairs by impact ionization. The d-c component of the electric field causes electrons and holes to drift in opposite directions, resulting in a net avalanche current.

Time lag. As the a-c component of the field changes, the avalanche-

generated current lags behind because it takes time for the ionization rate to increase and decrease. It's been shown in the case of small signals that the rate of change of the avalanche-generated current is proportional to the a-c field, that is, di/dt is proportional to E_{a-c} . Thus, the buildup of avalanche-generated current resembles the buildup of current through an inductor under an a-c voltage; the current lags the voltage 90° .

While the avalanche-generated carriers travel across the drift region, current flows in the resonant circuit. This external current peaks at the same time the peak number of carriers are halfway across the drift region. The length of the drift region is chosen so that the total carrier transit across it takes half a cycle. The peak external current then occurs a quarter of a cycle, or 90° , after the peak injected current.

Half circle. The net phase shift between applied voltage and ex-

ternal current is thus 180° , the sum of the 90° phase lags caused by avalanche buildup and transit time.

In the four-layer Read diode, avalanche is confined to a thin region, whereas it may occur across a large part of the n-region in a three-layer structure. Doping of the n-region in either type of diode should be light enough so that full depletion occurs before avalanche breakdown. Otherwise, efficiency suffers because:

- Over part of a cycle, the electric field in the undepleted region drops below the value required for the carriers' saturation-limited velocity. This can cause a decrease in carrier phase coherence.
- The undepleted region acts as a nonlinear parasitic series resistance.
- The diode capacitances will vary with voltage and can cause a-c power to be wasted in parametrically generated sidebands and harmonics.



noise diode developed previously by a Texas Instruments physicist, R.H. Haitz. Using a guard ring—an auxiliary electrode that shapes the electric field across the junction to guarantee uniform breakdown—Haitz achieved a uniform decrease of noise as current drops. The tests indicate that the double epitaxial diode has a very uniform avalanche breakdown.

Just as rugged mechanically and thermally as the diffused devices, double-epitaxial diodes aren't significantly affected by the ultrasonic bonding employed in TI's flip-chip process or by any other fabrication and mounting step. Prototype double-epitaxial diodes have delivered up to 700 milliwatts of c-w power at X band with 7% efficiency—figures that compare favorably with the performance values for diffused diodes of similar dimensions. And powers should increase with enlarged junctions and fabrication refinements.

A further advantage of these diodes is that they turn on with high efficiency—about 5% when run 50 mw or so above the oscillation threshold. As more d-c current is applied, efficiency climbs slowly to 7%. Diffused diodes, on the other hand, are generally very inefficient when run at low powers.

This behavior of the double epitaxial device at low power apparently reflects the full depletion of the n^- region at low currents because of the abrupt n^-n^+ interface. Conversely, diffused diodes probably don't fully deplete at low input-power levels because doping isn't uniform near their n^-n^+ interface; their undepleted region becomes smaller at higher powers, though, and efficiency therefore improves.

It should be noted that out-diffusion is a problem with silicon diodes because even the slowest dopant used with this material, antimony, moves rapidly out of the substrate at the high fabrication temperatures required. The gallium used as a dopant in germanium diodes, on the other hand, hardly diffuses out of the substrate at all during fabrication.

Beating the heat

It was engineers at Bell Labs who first successfully tackled the heat problem during diode operation by applying the flip-chip design. Their method—thermocompression bonding—involves joining the junction side of the diode under heat and high pressure to a gold-plated copper slug. Many other companies haven't had success with this technique because bonding at too high a temperature causes the silicon and gold to alloy together. And lowering the bonding temperature necessitates raising the pressure, thereby risking physical damage to the diode.

Texas Instruments has taken a different approach to flip chipping. Their modified form of thermocompression bonding can be done at somewhat lower temperatures and considerably lower pressures. The TI technique involves the use of ultrasonic scrubbing; the gold contact on the silicon and the gold plated heat sink are rubbed together so that their surfaces "wet" each other—that is, make close molecular contact.

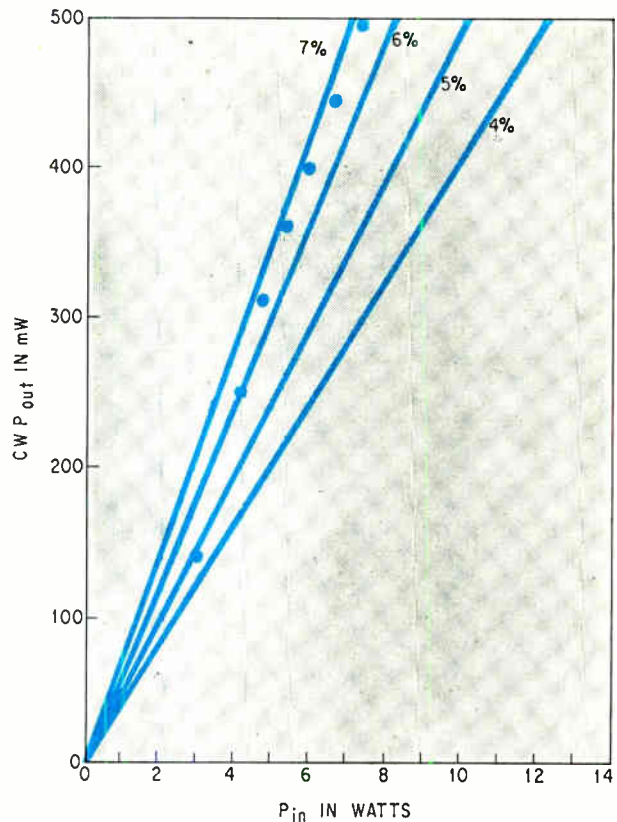

Ins and outs. Dots show efficiencies of about 9 GHz for TI diodes while lines show projected efficiencies.

Flip-chip silicon diodes dissipate about three times as much heat as do noninverted diodes. On the other hand, germanium and gallium-arsenide diodes dissipate up to 10 times as much heat when inverted because they're both relatively poor conductors to begin with. Therefore, flip chipping tends to remove silicon's heat advantage. While this is yet another plus for germanium, silicon continues to dominate the avalanche-diode field because its technology is more advanced.

Other methods of improving heat dissipation include bonding to diamond or silicon-carbide heat sinks and the paralleling of several diodes. The problem with paralleling is that it's difficult to get identical bonds and to match electrical characteristics. The general practice now is to bond a number of diodes to a sink, draw current through each, and then scratch off the ones that don't perform.

Deciding which of the diodes to retain is itself a major problem. Until recently, measuring a diode's thermal resistance was a complicated procedure and usually meant burning out the device. But TI has developed an accurate and simple technique that's based on the fact that thermal resistance just about disappears at high frequencies because of the avalanche mechanism.

At low frequencies, the diode's net series resistance consists of the thermal resistance and such other terms as the contact and space charge resistance. Therefore, subtracting the high-frequency

series resistance from the low-frequency series resistance gives the thermal resistance in ohms. The big advantage here is that this method can be used to measure the resistance of diodes in circuits without destroying them.

As new techniques continue to be developed, knowledge of the avalanche transit-time mechanism is increasing. A recent study showed that the temperature-dependent current-density distribution in avalanche diodes becomes time dependent during pulsed operation. The pulses can become distorted because the oscillation frequency depends on current density. And since thermal time constants are typically tenths of microseconds, they can cause an appreciable delay between the bias pulse and the output r-f pulse.

Some experimenters have even reported an initial and a delayed mode during pulsed operation. At first, an annular region near the diode's edge conducts most of the current. But the rise in temperature due to conduction causes less current to flow in this region and more current to flow in the cooler center area. And this shift affects r-f output, frequency, efficiency, and noise behavior.

Score card

Today's avalanche diodes offer microwave power in a range from milliwatts to watts, efficiencies as high as 15%, and very large power-impedance products.

TI has obtained 5 to 10 watts of peak pulse power at frequencies from 6 Ghz to 15 Ghz from silicon $p^+n^-n^+$ diodes with diameters of 4 to 5 mils. Efficiencies are generally less than 6%, however. C.A. Burrus and L.S. Bowman of Bell Labs have reported the pulsed operation of silicon diodes over the millimeter range up to 340 Ghz; typical figures were 15 mw at 100 Ghz and 1 mw at 300 Ghz.

Others have claimed higher power levels, but from diodes much larger in area and having, therefore, very low power-impedance products. Moreover, their results indicate that large areas of their diodes acted as parasitic shunt capacitances and resistances and didn't contribute to the r-f power output.

The highest c-w powers so far have been reported by T. Misawa and C.B. Swan of Bell Labs, who used a 4-mil silicon $p^+n^-n^+$ diode to produce 1.5 watts at 12 to 14 Ghz with efficiencies of 6% to 7%. Cooling this diode and circuit in liquid nitrogen boosted power output to 2.7 watts and efficiency to 10.2%.

Swan recently mounted a silicon diode on a gold-coated diamond chip to achieve 2.7 watts c-w power at 13 Ghz at room temperature. He has also paralleled five diodes to obtain 2.8 watts c-w at from 13 to 14 Ghz, and has gotten 4.7 watts c-w at 13 Ghz from two paralleled diodes on a diamond chip.

Because of gallium arsenide's higher carrier mobility, the material is potentially more efficient than either silicon or germanium. But material and fabrication problems have generally resulted in uneven and noisy breakdown, poor thermal conductivity,

and low efficiency. As far as the state of this art goes, S.G. Liu of RCA has achieved 1 to 2 watts peak pulse power in Ku band with an efficiency of about 5%.

D.R. Melick of Cornell has reported 0.38 watts of pulsed power at 6.8 Ghz and an efficiency of 7.8% with GaAs diodes, and 1.3 watts with 3.6% efficiency.

The integration of avalanche-diode oscillators in microstrip circuits at TI has produced 0.7 watts of peak pulse power at 9 Ghz. But efficiencies to date have been only about 1% because of the difficulty of tuning these experimental circuits for maximum power.

Other TI experiments on c-w Gunn diodes integrated on ferrite substrates show that impedances can be matched for maximum output by magnetic tuning. And efforts are under way to develop beryllia IC substrates for improved heat sinking.

Another road to avalanche

Several researchers have postulated a negative resistance from avalanche diodes at frequencies well below those required for the avalanche transit-time mode of operation. In an analysis of large-signal oscillations, Bernd Hoefflinger of Siemens suggested a feedback mechanism in which the space charge distorts the electric field at high current densities. The net result, he said, would be a low-frequency negative resistance. J.B. Gunn had advanced a similar theory back in 1956. And others, such as Bell Labs' Misawa predicted the same effects.

Hoefflinger reported oscillations from $p^+nn^-n^+$ silicon diodes at frequencies where the transit angle, $\omega\tau$, is much narrower than π . At frequencies from 100 megahertz to 2 Ghz, power and efficiencies were very low. Hoefflinger's theory is consistent with TI's report of low-transit-angle oscillations from $p^+n^-n^+$ diodes; power levels ranged from 1 to 6 watts at from 2 to 6 Ghz, and efficiencies were near 1%. And TI recently got c-w powers of 150 to 150 mw in a low-transit-angle mode at ultrahigh frequencies; efficiency was about 7%.

However, the theory doesn't account for the spectacular results reported by H.J. Prager, K.K. Chang, and S. Weisbrod of RCA, who claimed low-transit-angle oscillations of several hundred watts at frequencies below 1 Ghz with efficiencies from 25% to 60% from silicon $p^+n^-n^+$ diodes. No one to date has duplicated these results.

When efficiency is that high it becomes a parameter itself, ruling out many otherwise feasible explanations of these results. A 60% level implies Class C operation, a condition in which external current flows over only a small portion of the cycle. But this, in turn, implies that the time delay causing the negative resistance cannot be due to the transit time of carriers travelling at saturation velocity across the depletion region, because external current flows continuously during such travel. Any explanation of these results would have to allow for efficiencies even higher than 60% because circuit and contact losses would have to be accounted for.

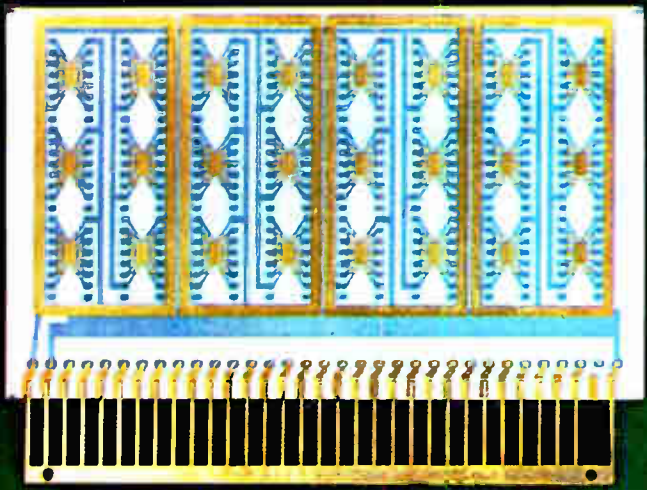

FRONT

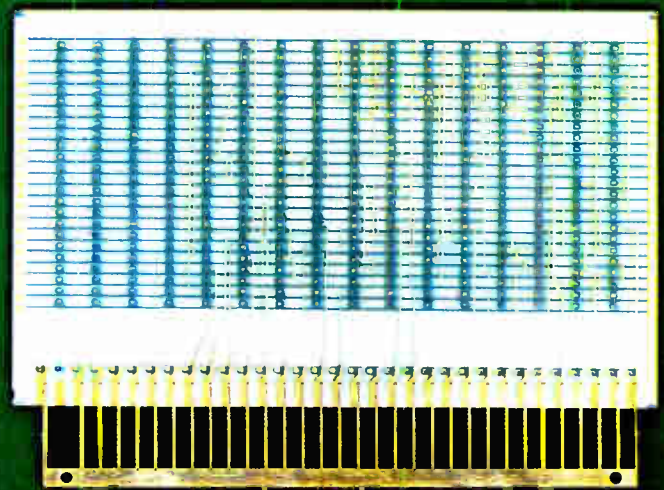

BACK

PROGRESS REPORT

ALSiBASE[®] COMPOSITE SUBSTRATES

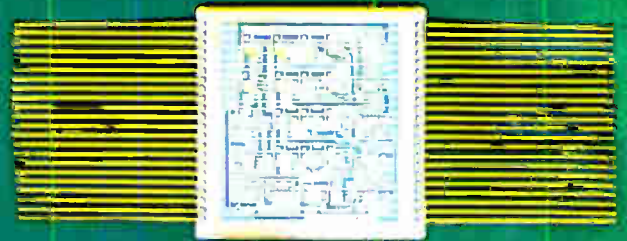

Courtesy United Aircraft

ALSiBase Composite Substrates have demonstrated their ability to pack so much dependability and performance in so little space that our engineers have been asked for many new features in custom designs. We are continuing our work on many of these requests.

Some requests have been met. Here are a few examples of progress.

On most designs, ALSiMag 772 alumina ceramic with surface finish of 8 microinches (CLA) or better, can be used to provide a top surface suitable for thin film deposition. Via holes can be flush with the top surface. A standard array of via holes can be designed to allow a number of different circuits off the same basic composite structure.

Ground and voltage planes can be placed at any level and connections from other levels made to these planes wherever desired. Connections also may be made between signal planes located above and below ground or voltage planes by means of insulated passages through these planes.

Any number of planes can be stacked on one side or on both sides of the base substrate with interconnections made through the substrate.

ALSiBase Composite Substrates permit the designer to stack electrically conductive patterns by planes, separated and insulated by layers of ALSiMag alumina ceramic. All internal circuitry is thus hermetically sealed. Conductive interconnections join the metal planes wherever designed.

Greater device concentration in the same surface area is obtained because conductors can cross over and under each other without destroying the electrical integrity. Since the interconnections are encased in the ceramic they are secure against unintentional shorts. Shorter electrical paths result in faster switching and lower electrical resistance. Congested pattern areas may often be relieved by routing a portion of the conductors to another plane.

A summary sheet on ALSiBase Composite Substrates is regularly revised to keep pace with advances in technique. It gives design criteria, design parameters and suggests a preferred method for drawing and dimensioning inquiries on ALSiBase Composite Substrates. A copy of the newest sheets on Composite Substrates is available on request. Please use your business letterhead.

CODE IDENT. NO. 70371

PHONE 615 265-3411, CHATTANOOGA, TENN. 37405

American Lava Corporation **3M**
A SUBSIDIARY OF COMPANY

For service, contact American Lava representatives in Offices of Minnesota Mining and Manufacturing Company in these cities (see your local telephone directory): Boston: Needham Heights, Massachusetts • Chicago: Elmhurst, Illinois • Dallas, Texas Elyria, Ohio • Laurens, S. C. • Los Angeles, California • Metropolitan New York: Ridgefield, N. J. • Up-State New York and Canada: Phoenix, New York • Orange, Conn. • Philadelphia, Penn. • Roanoke, Va. • St. Louis: Lee's Summit, Mo. South San Francisco, Calif. • 3M International: c/o American Lava Corp., Chattanooga, Tenn. 37405, U.S.A., 615/265-3411.

67th
YEAR
OF
CERAMIC
LEADERSHIP

Capacitor problems?

General Electric has 1844 application-designed solutions

General Electric's application-designed capacitors are made to solve your problems. Whether you need aluminum, tantalum, or film units, GE has the right answer.

Circuit design problems? Many General Electric capacitors are designed by computer to optimize their electrical and mechanical characteristics. You get the highest capacitance in the least volume with electrical properties consistent to your own circuit designs. For example, if you know your installed capacitance requirements in a new power supply, our computers can quickly tell you the best capacitor combination and its electrical characteristics in your circuit.

Product application problems? General Electric has experienced capacitor application en-

gineers in Electronic Components Sales Offices throughout the country. These technical specialists are ready to help you select the capacitors you need and to provide specialized information about them.

Ordering or delivery problems? Your local Electronic Components Sales Office will be glad to furnish you price and delivery data for General Electric capacitors. We also have stocking distributors who can meet many of your immediate requirements for limited quantities of standard units.

You supply the capacitor problems. General Electric can supply 1844 application-designed solutions. Contact your local sales office, franchised distributor or **Capacitor Department, Irmo, South Carolina 29063.**

430-32

GENERAL  ELECTRIC

NEW IDEAS IN
ELECTRONICS



Aluminum High-performance Computer-grade Capacitors
236 standard ratings. 5 to 450 volts,
75 to 480,000 μf , -40
to 85C ambient temperature



Aluminum Miniature Tubular Capacitors
151 standard ratings. 3 to 150 volts, 1 to
790 μf , -40 to 85C ambient temperature



Aluminum Industrial Tubular Capacitors
102 standard ratings. 3 to 450 volts, 2 to
3500 μf , -20 to 85C ambient temperature



Tantalum Sub-miniature Wet-slug Capacitors
59 standard ratings. 6 to 60 volts,
0.01 to 450 μf , -40 to 85C ambient temperature

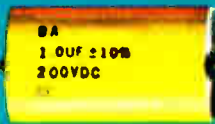

Metallized Film Flattened Oval Capacitors
102 standard ratings, 100 and 200 volts
d-c, 0.01 to 10.0 μ f, -55 to 85C



Metallized Polycarbonate Tubular Capacitors
57 standard ratings, 200 volts d-c, 0.010
to 10.0 μ f, -55 to 125C

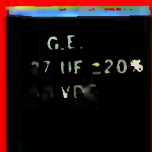

Microfilm Polyester Capacitors
78 standard ratings, 50 volts
d-c, 0.0010 to 1.50 μ f, -55 to 85C



Polyester Tubular Capacitors (left)
296 standard ratings, 100
and 200 volts d-c, 0.0010
to 2.00 μ f, -55 to 85C

Black Hawk Capacitors
463 standard ratings, 50
to 600 volts, 0.0010 to
1.00 μ f at 85C

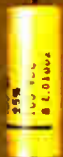

Polycarbonate Tubular Capacitors (left)
84 standard ratings, 100
and 200 volts d-c, 0.001 to
1.0 μ f, -55 to 85C

Ray Jay Capacitors
74 standard ratings, 100 and
200 volts d-c, 0.001 to 0.07 μ f



Aluminum Can-style Capacitors
43 case size and terminal combinations—thousands of ratings.
5 to 450 volts, 5 to 500 μ f, 1, 2,
3, or 4 sections



Aluminum A-c Motor Start Capacitors
123 standard ratings, 110 to
330 volts a-c, 21 to 850 μ f,
-20 to 65C ambient temperature

Storing light and current in crystals

Ability to absorb energy and release it when tapped makes some lithium- and sodium-doped semiconductors potentially useful as infrared detectors, optical memories, and other optoelectronic devices

By Yoon S. Park and Cole W. Litton

Aerospace Research Laboratories, Wright-Patterson Air Force Base, Ohio

Heating or illuminating certain types of crystals gives startling results and may, as a technique, provide the basis for a new family of devices. Certain group II-VI semiconductor compounds doped with lithium store energy when heated, releasing it as a light pulse when they're mechanically tapped. These same materials doped with sodium and stimulated optically not only flash when tapped but also when exposed to infrared light. Further, their electrical conductivity jumps appreciably after stimulation, and when they're electroded, they show negative resistance related directly to the intensity and duration of stimulation.

Although these so-called "tap effects" were first observed several years ago by Donald C. Reynolds and Douglas M. Warshauer of the aerospace research laboratories at Wright-Patterson Air Force Base, it's only recently that the causes have been pinpointed. It's been established that the sodium and lithium impurities are responsible for the light-storage capability, high conductivity, and controllable negative resistance. And it's now possible to grow large single crystals of sufficient quality to be used in experimental devices.

Of immediate interest is a design for an infrared detector that promises much higher efficiencies than can be achieved with conventional photoconducting devices. As the tap-crystal device is envisioned, a mosaic of sodium-doped crystals would first be stimulated by ultraviolet or blue light. Then, in its storage state, the mosaic would "look" at the reflected infrared signal from a target and typically give off a visible photon for every 10^4 infrared photons. Because each visible photon potentially can generate 10^6 electrons in a light-amplifying system, gains of 10^2 from infrared to the visible are anticipated. The amplified image could then be seen on a television screen.

Other potential applications of tap crystals include lasers that theoretically could cover the entire range from infrared to ultraviolet, computer memories, tuned oscillators, negative-resistance amplifiers, and optical exposure meters.

The range of applications depends in part on the number of different group II-VI compounds, doped with group I impurities, that can be successfully grown. There's good reason to believe that any crystal in these classes will show tap effects. To date, though, cadmium sulfide, cadmium selenide, zinc sulfide, and zinc oxide, doped either with sodium or lithium, are the only tap crystals that have been grown.

They're produced by a vapor-phase technique; the compound and dopant are mixed together in a sintered powder, sublimed, and then condensed in an oxygen-free atmosphere at temperatures ranging from 900° to $1,500^\circ\text{C}$. CdS powder containing 0.1 to 0.01% lithium hydroxide or sodium hydroxide produces crystals that are 100 to 500 parts per million lithium or sodium.

Flashing lights

For maximum effectiveness, tap crystals must be cooled to a temperature of at least 77°K . Experiments show that sodium-doped CdS crystals flashed green and the ZnO crystal blue-green when exposed to infrared radiation or tapped in a direction parallel to the c axis, the crystal's hexagonal axis of symmetry. But when tapped perpendicular to this axis, the crystals flashed weakly or not at all. The sodium-doped crystals flashed up to several hundred times—once for each tap—before their stored energy was depleted.

The emitted light radiates in streamers from the point of impact along the direction of the c axis. As with ultraviolet emission in photo luminescent



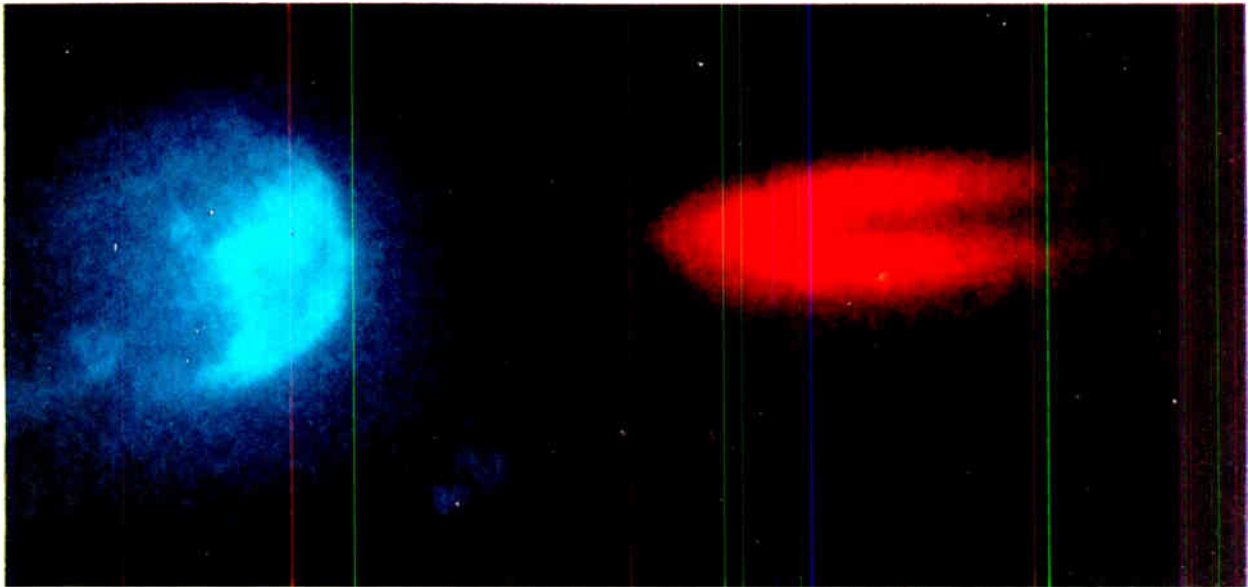

Infrared trigger. Lithium-doped ZnS crystal flashes blue as hot soldering gun bathes it with infrared light.

materials, the light's electric vector is polarized perpendicular to the *c* axis. Both types of luminescence are often called "edge emission" because light is emitted in the wavelength region corresponding to the forbidden gap energy (the absorption edge) of the crystal.

Lithium-doped crystals behave somewhat differently. Exposure to optical radiation doesn't cause them to store energy. But they do store energy if they're heated to about 200°K and then cooled to 77°K. Tapping must be done in the dark because ambient light quenches emission. The gentlest tapping, sometimes only the rattling due to heating the crystal, is enough to induce emission. Lithium-doped crystals flash very uniformly in all directions but a few taps exhaust their stored energy.

Because lithium-doped CdS crystals are also photoluminescent, it's possible to compare the spectra resulting from ultraviolet and tap excitation. Photographs that were taken with 10,000 ASA speed film through a fast spectrograph with a dispersion of 11 Å per millimeter pointed up similarities and differences.

As the chart on the next page shows, both spectra peak at the same wavelengths beginning at 5,129 Å.

Side effect

In discharging energy, the excited electron drops to the ground state, and gives off a photon. As it drops, it interacts with the crystal lattice (which is always in vibration) and gives up some of its energy to it, energy that is then released by the crystal in the form of phonons (quanta of thermal energy). The peaks thus correspond to optical transitions where no phonons are emitted, and to transitions at progressively higher frequencies when increasing numbers of phonons are released.

Tapping causes optical transitions to take place throughout the bulk of the crystal, whereas ultraviolet radiation involves only the crystal's surface.

Apparently, the tap bulk effect accounts for the strong and very narrow (about 40 Å wide) peak at 4,900 Å; the ultraviolet spectra shows almost no energy at that wavelength. The intensity and sharpness of this peak has raised hopes that a CdS diode laser may eventually be developed to operate at 4,900 Å.

The pulse from a lithium-doped tap crystal has a long tail and sharp peak with a rise time of 10^{-8} seconds, a characteristic that could be useful in application involving high-speed impact photography.

Normal CdS or ZnO crystals grown from pure materials have resistivities of a few ohm-centimeters. Doping with lithium or sodium raises the resistivity to about 10^4 ohm-centimeters, and the crystals become photoconducting. Electrical conductivity drops still further when the sodium- or lithium-doped crystals are cooled in the dark to about 10^{-11} mhos per centimeter. However, stimulating the sodium-doped crystals with light increases their conductivity to levels as high as 10^{-3} mhos per centimeter.

What is particularly useful is that the raised conductivity in the sodium-doped crystal remains high when the stimulating light is removed—as if electrons were stored in the conduction band. Therefore, these tap crystals are also called "storage crystals." Their high conductivity isn't affected by tapping because as soon as they emit light, they reabsorb part of it. Lithium-doped crystals, on the other hand, don't show the storage property.

Cold storage

The stronger the light stimulation, the faster the tap crystal reaches maximum conductivity. These crystals carry the highest currents—and emit the strongest light pulses—at 77°K. The current in CdS crystals slowly decays as temperature rises, and drops rapidly at 200°K. In ZnO, the sudden drop

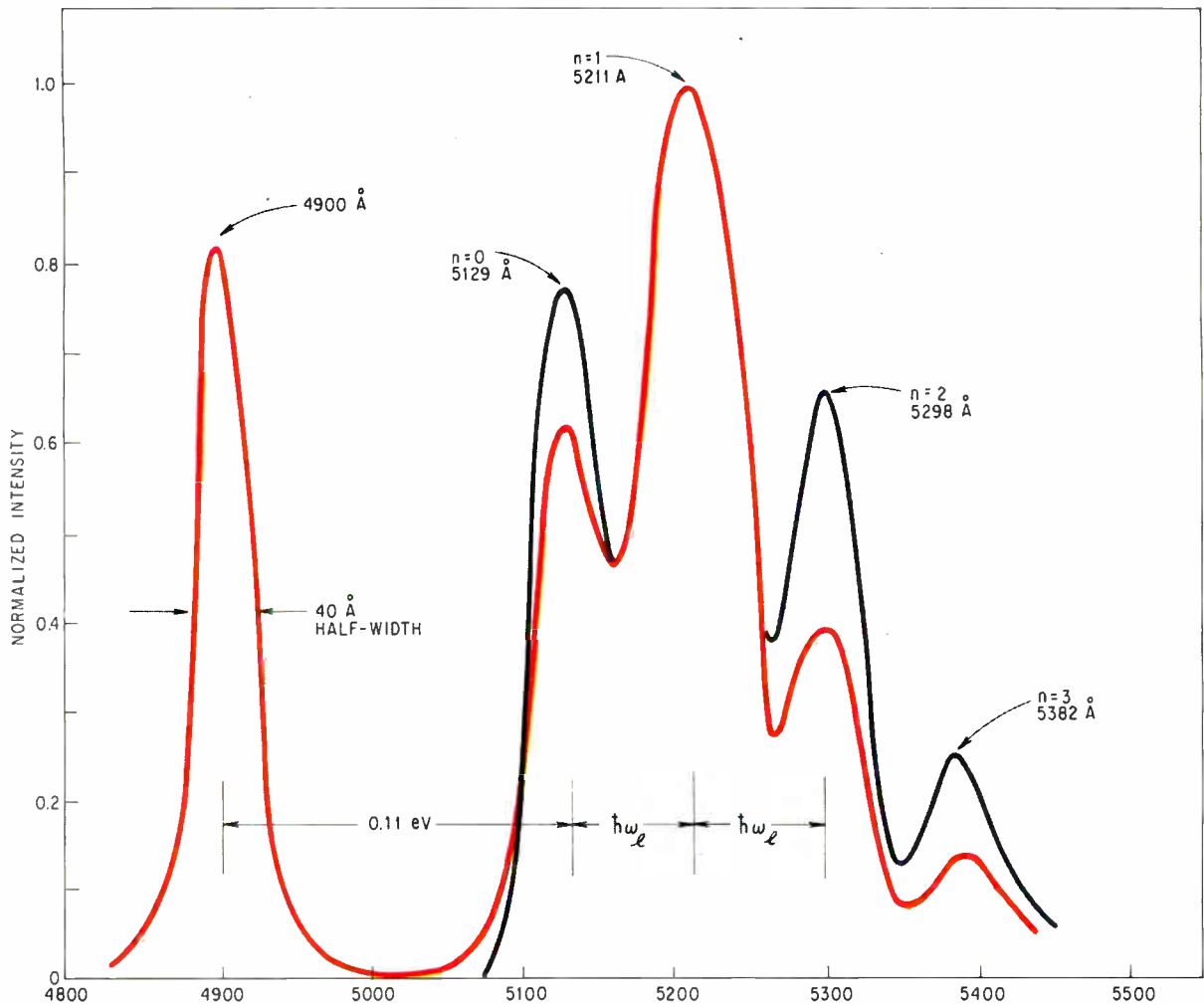

Tap colors. Spectra from mechanically-excited CdS tap crystal (color) and ultraviolet-excited crystal are similar. Most striking difference is the sharp peak at 4,900 angstroms in the mechanically-excited spectrum.

starts at 167°K although current jumps momentarily at four discrete temperatures—126°, 185°, 206°, and 235°K.

The amount of optical stimulation, as noted before, also determines the negative resistance characteristic of the sodium-doped crystals. Even though negative resistance has been found in some normal CdS crystals, this direct dependence of threshold voltage (V_t) and minimum voltage (V_m) on stimula-

tion is unique to these semiconductor compounds.

When the sodium-doped crystal is electroded with an indium cathode and silver anode, the voltage increases with current until a point is reached at which the indium electrode injects electrons and the silver electrode injects holes, thereby causing the voltage to drop very sharply into the negative-resistance region as current increases. The absorption of the stimulating radiation by hole traps apparently increases their lifetime, thereby widening the negative-resistance region of the crystal. When a tap crystal was connected to a tank circuit, stimulated, and biased near the threshold voltage, for instance, it was possible to get stable oscillation at frequencies ranging from 60 hertz to a few kilohertz by tuning the tank circuit.

Although not enough work has been done with tap-crystal oscillators to compare them with, say, gallium arsenide bulk-effect devices, the ability to change oscillating frequencies by varying the level of alkali-metal doping is promising.

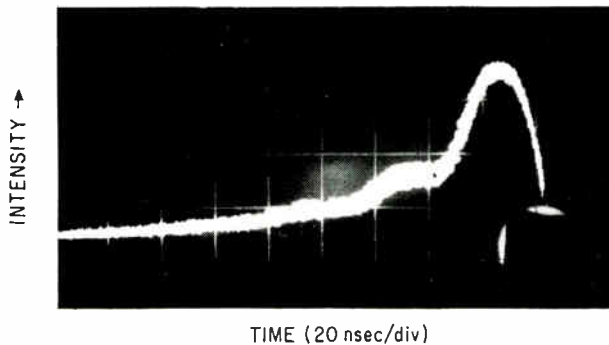

Quick flash. Pulse emitted by lithium-doped CdS crystal has sharp rise time and can be used in such applications as high-speed ballistics photography.

Holes and traps

Explaining the light-storage effect requires the postulation of electron and hole traps—discrete en-



ergy levels within the "forbidden" region of the crystal. Stimulating a CdS crystal with a wavelength of the bandgap light produces hole-electron pairs; electrons in the valence band are sent up to a trap 0.14 electron-volts below the conduction band, leaving behind holes in a trap 0.75 eV above the valence band. Stimulating the same crystal with light of 6900 Å excites electrons in the hole trap (which is also an electron trap in the dark) leaving behind trapped holes.

Energy remains stored until tapping or infrared excitation frees a trapped hole, allowing it to recombine with a trapped electron. Thus, the trapped holes act as the storage medium in the crystal.

In lithium-doped crystals there might be traps near enough above the storage level to pick up electrons stimulated out of storage as the crystal is being cooled. Mechanical excitation frees the trapped holes, which then combine with the electrons.

This explanation may be a bit oversimplified but it does describe experimental observations.

Since the optical bandgap in CdS is 2.50 eV (5000 Å) and the threshold for optical stimulation in CdS is 6,900 Å, the hole trap level is therefore about 0.75 eV above the valence band. And 0.75 eV corresponds to infrared light of 1.65 microns, explaining why CdS crystals emit when exposed to this wavelength.

The optical stimulation threshold in ZnO occurs at 3,680 Å. The hold trap is thus about 0.065 eV above the valence band, corresponding to infrared light of 19 microns wavelength. Detectors can be built, therefore, to respond to infrared radiation of various wavelengths.

Mechanics of release

The details of hole release in tap crystals still aren't clearly understood. It seems, though, that the pyroelectric nature of lithium-doped CdS crystals plays an important part. Cooling the crystal generates an electric polarization; the cadmium side becomes positively charged and the sulfide side negatively, producing an electric field of about 10^5 volts per centimeter. Moving a conductor slowly toward one of the faces causes the crystal to spark, demonstrating the existence of the field. Tapping the crystal affects the field, which in turn frees the trapped holes.

The trapped holes in the sodium-doped crystals are released either by the strain wave set up by the tap or a short-lived piezoelectric potential generated by the strain wave moving through the crystal as a dipole field. Experiments are now being conducted to clarify these theories.

Relating the release mechanism to the current storage property of sodium-doped crystals also requires further study. B.A. Kulp, K.A. Gale, and R.G. Schulze of the aerospace labs at Wright-Patterson recently completed a detailed study of the high conductivity in stimulated tap crystals. Their experiments showed that carrier mobility in these crystals is anisotropic and is on the order of 1 to 10 $\text{cm}^2/\text{volt-second}$ parallel to the c axis at

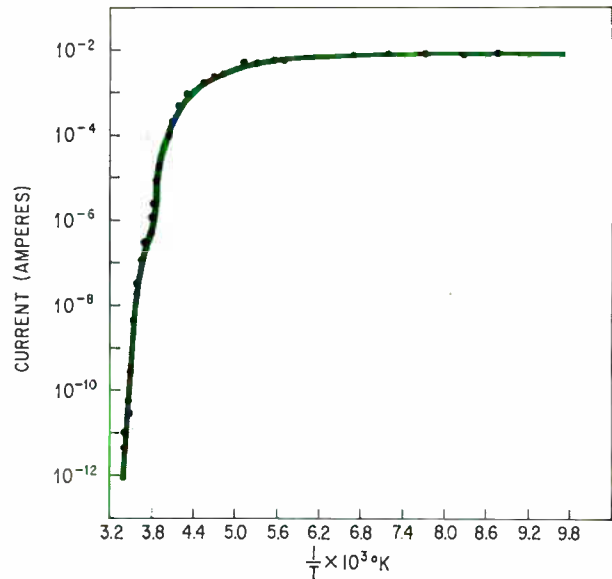

Threshold. Plot of electrical conductivity in sodium-doped CdS tap crystal against reciprocal temperature shows a gradual decay of current as temperature rises until a sudden drop point is reached. Temperature range covers 115° to 300°.

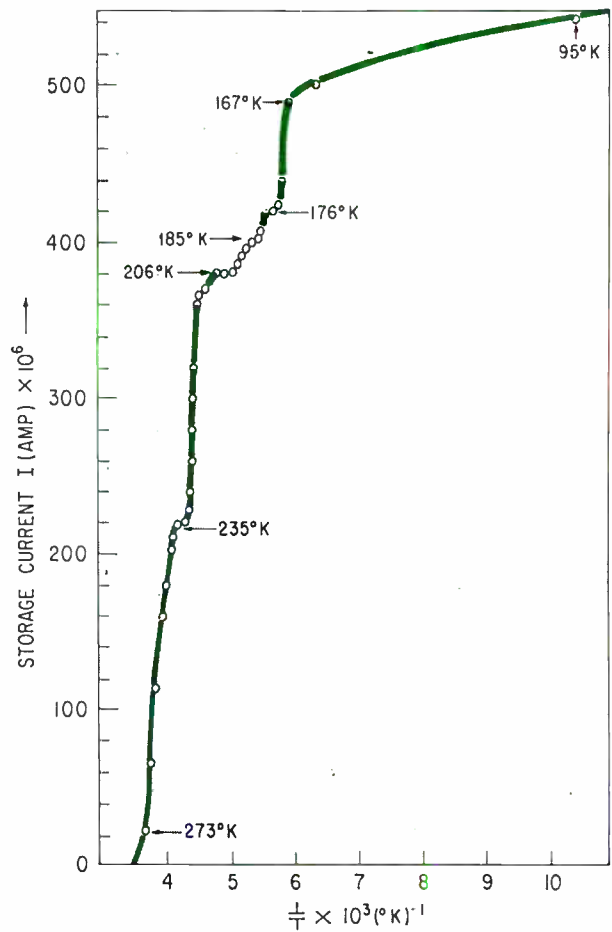

Current curve. In sodium-doped ZnO tap crystals that have been thermally stimulated electrical conductivity increases, remaining high at low temperatures. But current drops sharply at about 167°K and picks up briefly at 176°, 185°, 206° and 2,350°K. Curve starts at 77°K and extends to room temperature.

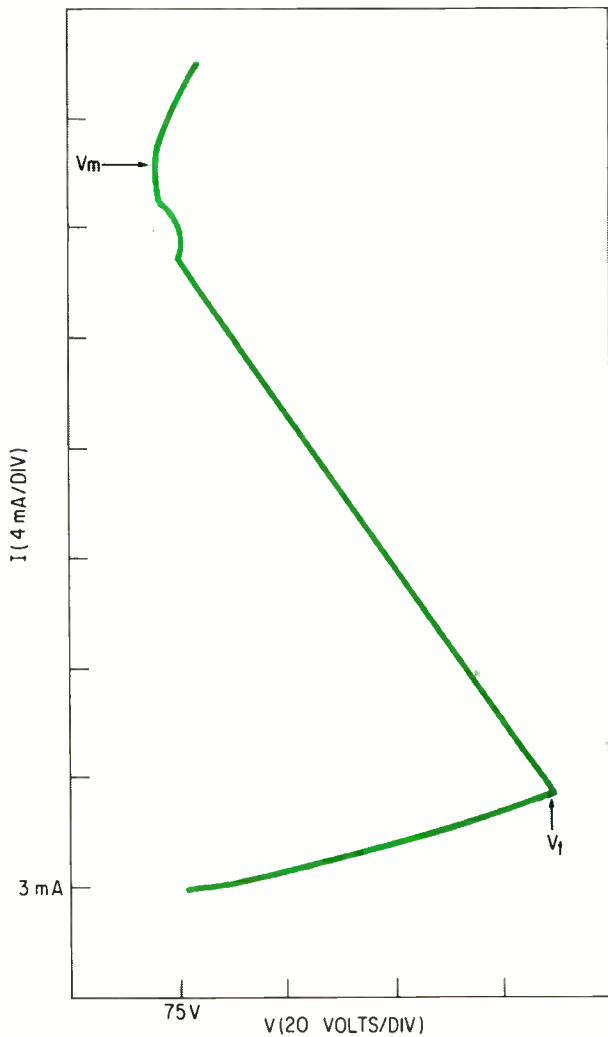

Negative resistance. Oscillograph of the current voltage characteristic of a sodium-doped CdS crystal at 4.2°K shows negative resistance. Values of V_t and V_m are, respectively, 145 v ($I=7\text{ ma}$) and 75 v ($I=29\text{ ma}$). Tap crystals are unique because their negative resistance depends on the intensity and duration of stimulation.

low temperatures and from 10 to 30 times that perpendicular to the axis.

Carrier mobility in undoped CdS crystals doesn't vary in relation to direction and is very low at low temperatures. The findings indicate that electrons taking part in luminescence and conduction are in an impurity band rather than the conduction band.

On to the drawing board

To investigate the practical applications of tap effects, engineers have built a simple energy storage device consisting of a sodium-doped crystal in a container cooled by liquid nitrogen. After stimulation by ultraviolet light, the crystal is tapped on its side by a metal lever moved either mechanically or electromagnetically. As the crystal flashes, a photomultiplier senses the emission.

An electromechanical transducer—a piezoelectric crystal, for example—might also be used to tap the crystal. Lithium-doped crystals could be stimulated

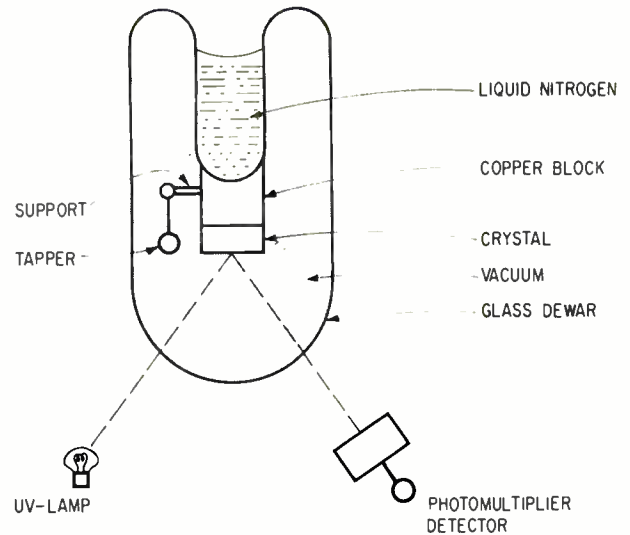

Storage device. This simple arrangement could form basis of memories, image intensifiers, or light meters.

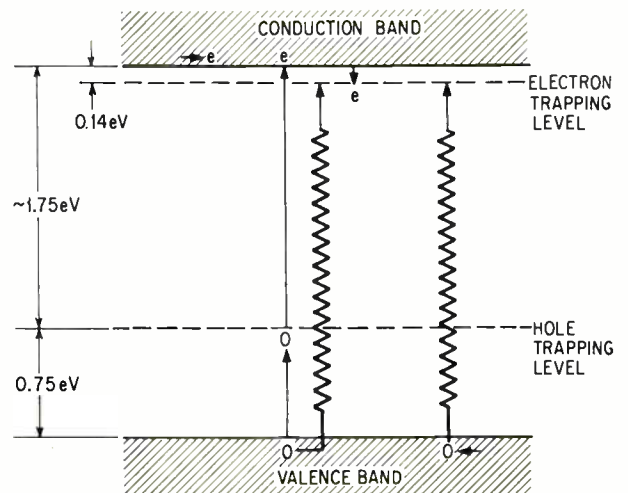

Energy model. Wavy arrows represent radiative transitions, solid arrows those of stimulating energy in this representation of tap storage mechanism.

thermally either by direct heating or by subjecting them to infrared energy of a very long wavelength.

Besides serving as an infrared detector, a mosaic of CdS tap crystals could also act as a frequency multiplier, taking in light at 6,900 Å, for instance, and converting to light of 5,200 Å. To vary the frequency of the emitted light, one would change dopants or select different crystals from the group II-VI family.

The potentially wide range of available colors has, of course, heightened interest in lasing diodes. But no one has been able to get these crystals in the form of diodes to generate coherent light. The major task now is to develop electrical contacts that can pass large amounts of current.

In yet another application, the sharp rise time of the crystals' emitted pulse could trigger a camera that might, say, photograph a bullet on impact. Shock waves generated by the speeding projectile would provide the necessary tap.

If any old evaporator is good enough...don't read this.

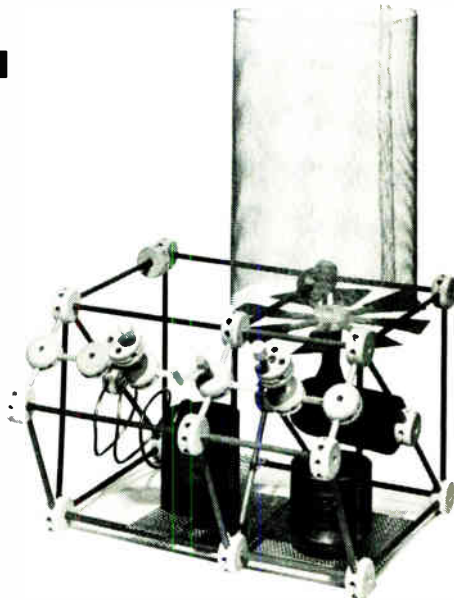

However,

If you're tired of fighting tinker toy equipment, look into Sloan's radical approach to thin film production. You get:

- 270° accessibility—waist high
- automatic valving sequences
- top and bottom access to collar
- integrated deposition control
- dual bell-jar capabilities plus horizontal or vertical positioning
- resistance and EB sources
- completely fixtured.

Write for data on our new vacuum system.

SLOAN

SLOAN INSTRUMENTS CORPORATION P.O. BOX 4608, SANTA BARBARA, CA 93103 PH. (805) 963-4431

Circle 244 on reader service card

Another new line of instruments from Lambda...



The high performance LR Series Power Supplies

0-20, 0-40, 0-120, 0-250 VDC
Up to 1.8 amps
Regulation: 0.0005% plus 100 μ V
Ripple: 35 μ V rms
AC Input: 105-132 VAC, 47-440 Hz
(Ratings based on 55-65 Hz)

With Remote Programming:
Accuracy—0.01%+1mV
Stability—0.001%+100 μ V for 8 hours
Temp. Coeff.—0.001% plus 10 μ V/°C

Constant current/constant voltage by automatic crossover
For rack or bench use
Guaranteed five years
Prices start at \$285

Model	Voltage Range	MAX. AMPS AT AMBIENT OF ¹				Price ²
		30°C	40°C	50°C	60°C	
LR-612-FM	0-20 VDC	1.8A	1.6A	1.3A	1.1A	\$285
LR-613-FM	0-40 VDC	1.0A	0.9A	0.75A	0.6A	285
LR-615-FM	0-120 VDC	0.33A	0.29A	0.25A	0.21A	285
LR-616-FM	0-250 VDC	0.1A	0.09A	0.08A	0.07A	325

¹ Current rating applies over entire voltage range. Ratings based on 55-65 Hz operation.
² Prices are for metered models. LR Series models are not available without meters.

OVERVOLTAGE PROTECTION For Use With	Model	Adj. Volt. Range	Price
LR-612-FM (0-20VDC)	LH-OV-4	3-24 V	\$35
LR-613-FM (0-40VDC)	LH-OV-5	3-47 V	\$35

Rack Adapter LRA-1
 5 1/4" Height
 x 16 1/2" Depth
 (For use with chassis slides)
 Price \$60.00



Rack Adapter LRA-2
 5 1/4" Height.
 Price \$35.00



Blank Front Panels
 Model LBP-10
 (1/4 rack size)
 Price \$5.00
 Model LBP-20
 (1/2 rack size)
 Price \$10.00

CHASSIS SLIDES: To order LRA-1 with chassis slides order LRA-1-CS, and add \$50.00 to price.

OR choose from these other Lambda power supplies

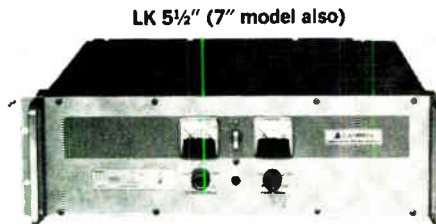
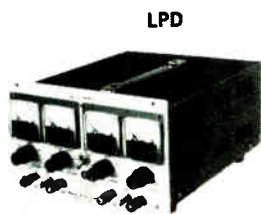

LP-LPD Series

A-C Input: 105-132 VAC, 47-440 Hz
Regulation: (line or load) 0.01% + 1mV
Ripple: 500 μ V rms, 1.5mV p. to p.

LH-LK Series

Regulation: (line or load) 0.015% or 1 mV
Ripple: LH models—250 μ V rms,
1 mV p. to p.
LK models—500 μ V rms

AC Input:

LH models—105-135 VAC, 47-480 Hz
LK models—105-132 VAC, 47-63 Hz
(LK 7" package available in
188-238 V and 205-265 V only)

Size 5 1/8" x 8 3/8" x 10 1/2" 1/2 Rack • LPD Series

Model ¹	Voltage Range Per output/ Outputs in series	I MAX AMPS AT AMBIENT OF: (1)				Price ² , US and Canada
		Per output Outputs in parallel				
	VDC	30 C	40 C	50 C	60 C	
LPD-421-FM	0-20/0-40	1.7A/3.4A	1.5A 3.0A	1.3A/2.6A	0.9A 1.8A	\$325
LPD-422-FM	0-40/0-80	1.0A/2.0A	0.85A/1.7A	0.7A/1.4A	0.55A/1.1A	260
LPD-423-FM	0-60/0-120	0.7A 1.4A	0.6A 1.2A	0.5A 1.0A	0.4A 0.8A	325
LPD-424-FM	0-120/0-240	0.38A/0.76A	0.32A/0.64A	0.26A 0.52A	0.20A/0.40A	325
LPD-425-FM	0-250/0-500	0.13A/0.26A	0.12A/0.24A	0.11A/0.22A	0.10A/0.20A	350

Size 5 1/4" x 19" x 16 1/4" Full Rack • LK Series

Model ¹	Voltage Range	CURRENT RANGE AT AMBIENT OF: (1)				Price ²
		40 C	50 C	60 C	71 C	
LK-350	0-20VDC	0-35A	0-31A	0-26A	0-20A	\$675
LK-351	0-36VDC	0-25A	0-23A	0-20A	0-15A	640
LK-352	0-60VDC	0-15A	0-14A	0-12.5A	0-10A	650

Size 7" x 19" x 18 1/2" Full Rack • LK Series

Model ¹	Voltage Range	CURRENT RANGE AT AMBIENT OF: (1)				Price ²
		40 C	50 C	60 C	71 C	
LK-360-FM	0-20VDC	0-66A	0-59A	0-50A	0-40A	\$995
LK-361-FM	0-36VDC	0-48A	0-43A	0-36A	0-30A	950
LK-362-FM	0-60VDC	0-25A	0-24A	0-22A	0-19A	995

Size 5 1/8" x 4 1/8" x 10" 1/4 Rack • LP Series

Model ¹	Voltage Range	CURRENT RANGE AT AMBIENT OF: (1)				Price ²
		30 C	40 C	50 C	60 C	
LP-410	0-10 VDC	0-2A	0-1.8A	0-1.6A	0-1.4A	\$129
LP-411	0-20 VDC	0-1.2A	0-1.1A	0-1.0A	0-0.8A	119
LP-412	0-40 VDC	0-0.70A	0-0.65A	0-0.60A	0-0.50A	114
LP-413	0-60 VDC	0-0.45A	0-0.41A	0-0.37A	0-0.33A	129
LP-414	0-120 VDC	0-0.20A	0-0.18A	0-0.16A	0-0.12A	149
LP-415	0-250 VDC	0-80mA	0-72mA	0-65mA	0-60mA	164

Size 5 1/8" x 4 1/8" x 15 1/2" 1/4 Rack • LH Series

Model ¹	Voltage Range	CURRENT RANGE AT AMBIENT OF: (1)				Price ²
		30 C	50 C	60 C	71 C	
LH-118A	0-10VDC	0-4.0A	0-3.5A	0-2.9A	0-2.3A	\$180
LH-121A	0-20VDC	0-2.4A	0-2.2A	0-1.8A	0-1.5A	170
LH-124A	0-40VDC	0-1.3A	0-1.1A	0-0.9A	0-0.7A	170
LH-127A	0-60VDC	0-0.9A	0-0.7A	0-0.6A	0-0.5A	185
LH-130A	0-120VDC	0-0.50A	0-0.40A	0-0.35A	0-0.25A	240

Size 5 1/8" x 8 3/8" x 15 1/2" 1/2 Rack • LH Series

Model ¹	Voltage Range	CURRENT RANGE AT AMBIENT OF: (1)				Price ²
		30 C	50 C	60 C	71 C	
LH-119A	0-10VDC	0-9.0A	0-8.0A	0-6.9A	0-5.8A	\$289
LH-122A	0-20VDC	0-5.7A	0-4.7A	0-4.0A	0-3.3A	260
LH-125A	0-40VDC	0-3.0A	0-2.7A	0-2.3A	0-1.9A	269
LH-128A	0-60VDC	0-2.4A	0-2.1A	0-1.8A	0-1.5A	315
LH-131A	0-120VDC	0-1.2A	0-0.9A	0-0.8A	0-0.6A	320

Size 5 1/8" x 8 3/8" x 15 1/2" 1/2 Rack • LK Series

Model ¹	Voltage Range	CURRENT RANGE AT AMBIENT OF: (1)				Price ²
		40 C	50 C	60 C	71 C	
LK-340A	0-20VDC	0-8.0A	0-7.0A	0-6.1A	0-4.9A	\$330
LK-341A	0-20VDC	0-13.5A	0-11.0A	0-10.0A	0-7.7A	385
LK-342A	0-36VDC	0-5.2A	0-5.0A	0-4.5A	0-3.7A	335
LK-343A	0-36VDC	0-9.0A	0-8.5A	0-7.6A	0-6.1A	395
LK-344A	0-60VDC	0-4.0A	0-3.5A	0-3.0A	0-2.5A	340
LK-345A	0-60VDC	0-6.0A	0-5.2A	0-4.5A	0-4.0A	395

Overvoltage Protection

Overvoltage protection up to 70VDC is available as a plug-in accessory with all LR, LP and LPD models and for LH and LK models with Suffix "A".

For models with this VDC	Specify this OV Accessory	Adj. Volt Range	Price
0-10, 0-20	LH-OV-4	3-24V	\$35
0-36, 0-40	LH-OV-5	3-47VDC	35
0-60	LH-OV-6	3-70VDC	35

Overvoltage protection up to 70 VDC as a built-in option for full rack LK models. To order, add suffix (-OV) and add \$90.00 to price of models LK-350-352; add \$120.00 for models LK-360-FM-362-FM.

NOTES:

- 1 Current rating applies over entire range. Ratings based on 57-63 Hz operation.
- 2 Prices are for non-metered models. For metered models, add suffix "-FM" and add \$10 to price for LP, \$30 for LH and LK.
- 3 Available metered only.
- 4 For chassis slides for full-rack models, add suffix "-CS" and add \$60 to price for 5 1/4" LK models, \$100 for 7" LK models.
- 5 All subrack models in this ad fit rack adapters described on previous page.

All specifications and prices subject to change without notice.

Write, wire, or call to order direct, for information, or for new Lambda Power Instruments catalog. LAMBDA Electronics Corp., 515 Broad Hollow Road, Melville, L. I., New York 11746, TEL. 516-694-4200, TWX 510-221-1897.



What's Hewlett-Packard doing in the volume components business?

Lowering the price of
Hot Carrier Diodes to...

55¢

Because we found a new way to build them: combining the superior performance of a hot carrier diode with the best features of PN junction diodes, eliminating the cat whisker of earlier designs, and using low-cost assembly techniques. The result is the HP 2800 Hot Carrier Diode with silicon temperature capabilities and turn-on equal to germanium. You get 100 picosecond switching speeds, 70 volt breakdown, low turn-on voltage at 410 mV at 1 mA, and operating/storage temperature of -65°C to 200°C . Ideal for RF and digital applications, or for mixing, detecting and sampling. Prices: 1000-4999, 55¢; 100-999, 75¢; 1-99, 99¢. Get the specs from your local HP field engineer, or write Hewlett-Packard, Palo Alto, Calif. 94304; Europe: 54 Route des Acacias, Geneva.

HEWLETT  PACKARD

SOLID STATE DEVICES

01809

Circle 302 on reader service card

Our drum beater

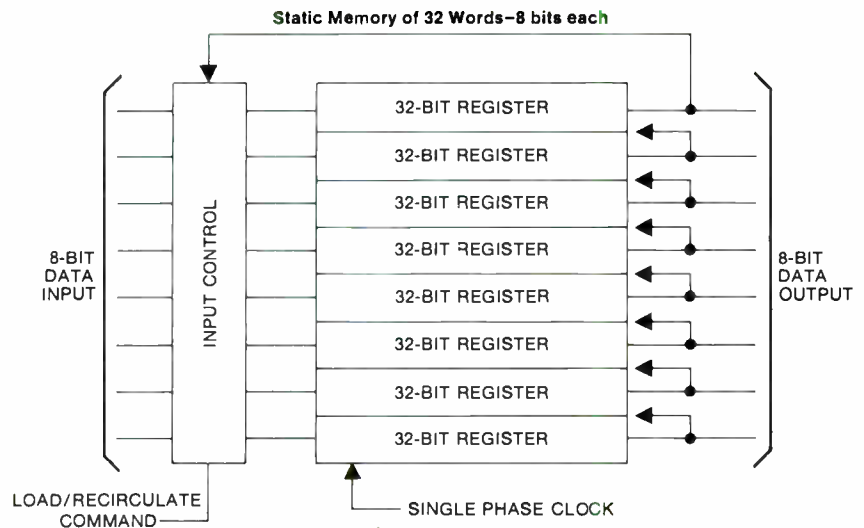

MM 505	DUAL 32-bit static register	4 pieces at \$30.00*each	\$120.00
MM 582	DUAL digital multiplex switch	4 pieces at \$ 8.00*each	\$ 32.00
		8 pieces	TOTAL \$152.00

*100 to 999 price

A drum memory as reliable as this would cost at least \$563.91. Our kit delivers now for \$152.00. For more on this, write National Semiconductor Corporation, 2975 San Ysidro Way, Santa Clara, California 95051. Or call (408) 245-4320.

National Semiconductor

General Electric introduces the smallest 50mw, 2-amp relay on the market



Tiny, powerful
and turned on with the touch of a feather



This extra-small, 2-pole, 2-amp relay needs only the slightest tickle to operate—50 milliwatts. With this impulse, it performs standard high-level output switching from low-level, microelectronic input.

Sizewise, it's only 0.32" high, 0.31" wide, and 0.61" long. And, it meets or exceeds all MIL-Spec environmental and electrical requirements of relays many times larger.

Because of its low operate power and size, this relay is ideally suited for microelectronic applications. Its low profile lets you stack many more circuit boards in the same space.

Like all General Electric 150-grid relays, this new 50mw type is available with a number of options to suit your individual application. You have a choice of coil ratings for a wide range of system voltages, a choice of popular mounting forms and header types.

If this new relay tickles your fancy, contact your General Electric Electronic Components Sales Engineer. Or, write for Bulletin GEA-8589, Section 792-43, General Electric Company, Schenectady, New York 12305.

GENERAL  ELECTRIC

SPECIALTY CONTROL DEPARTMENT, WAYNESBORO, VIRGINIA

Circle 246 on reader service card

for versatile research, development, and training

NEW HEATH MODULAR



delivery begins in September for any requirement—

Heath "805" Series Digital Instruments begin at \$940

The First Truly Universal Digital Instruments. The 805 Series Perform All These Functions:

- Frequency Meter, 12.5 MHz guaranteed
- Events Counter
- Integrating Digital Voltmeter (optional feature; EU-805A includes all functions; EU-805D does not have DVM function)
- Ratio Meter
- Time Interval Meter
- Period Meter
- Voltage Integrator

The 805 Features:

- 6 digit readout plus over-range
- 0.05% Accuracy As DVM
- Accuracy of ± 1 Count in all frequency, time interval, and period modes
- Count mode has electronic start & stop as well as manual
- Time Base Stability better than one part in 10^6 (15° to 55°C .)
- TTL Integrated Circuitry
- Compatibility with Heath 801 Digital System Modules for education and instrument development
- Versatile circuit cards can be used to make many instruments

Input Comparator Features:

- Two Independent Input Comparators
- Automatic Mode Triggering
- Rear Panel Comparator Outputs
- Switch Selection for AC or DC Coupling or Signal Disconnect

- Four Levels of Input Attenuation
- Includes Provisions for Independent use of Input Comparator B
- Input Comparator B may be controlled at rear panel to provide Main Time Base Input

Readout Features:

- Front Panel Display Memory Switch
- Front Panel Accumulate Switch
- Extended-Range Variable Display Time
- Rear Panel Input for External Time Standard
- Rear Panel Access to Clock/Scaler provides Standard Time Intervals in Decades from 1 microsecond to 10 Seconds, or Continuous 1 microsecond
- Voltage to Frequency Output available at Rear Panel when operating in any mode

Events Counter Features:

- Either Manual or Electronic Gating for Start & Stop
- Events may be scaled in Decade Steps to 10^7 ... 6 digit display permits count to 10^{12} without over-ranging
- Input Pulse Resolution better than 50 Nanoseconds.

Frequency Meter Features:

- Frequency Measuring Capability better than 12.5 MHz
- Two-Channel Input for Frequency Comparison or A/B Ratio Measurements
- Resolution at Max. Gate Time 0.1 Hz ± 1 Count
- Time Bases, 1, 10, 100 microseconds; 1, 10, 100 milliseconds; 1 & 10 seconds

Digital Voltmeter Features:

- High Accuracy Integrating Type
- 5 gigohms (5×10^9) Input Impedance on separate 1 v. Range (10 microvolt resolution)
- 1, 10, 100 & 1000 Volt Ranges — 10 megohm input impedance
- Selectable Gating/Integrating Times ... 0.1, 1, 10 Seconds
- Automatic Polarity Indication
- 10% Over Range Capability

Time Interval Meter

- Either Manual or Electronic Gating for Start and Stop
- Switch Selection for minimum Time Resolution; 1, 10, 100 microseconds; 1, 10, 100 milliseconds; 1 & 10 seconds
- Resolution ± 1 Count

Period Meter Features:

- Either Manual or Electronic Gating for Start & Stop
- Switch Selection for minimum Period Resolution; 1, 10, 100 microseconds; 1, 10, 100 milliseconds; 1 & 10 seconds
- Resolution ± 1 Count

- Two-Channel Input for Period Comparisons or A/B Ratio Measurements

Ready For September Delivery:

- Assembled EU-805D, as above less DVM function, (EU-805-12 may be added later if desired at \$340) \$940
- Assembled EU-805A, Universal Digital Instrument with DVM \$1250



HEATH COMPANY, Dept. 580-04
Benton Harbor, Michigan 49022

- Please Send Free EU-805 series Spec. Sheet
- Please Send Free EU-801 System Modules Spec. Sheet
- Please Send Free Circuit Card Spec. Sheet

Name _____
Company _____
Address _____
City _____ State _____ Zip _____
(prices & specifications subject to change without notice) EK-250

FREE SPECIFICATION SHEETS

EU-805A/D UDI Spec. Sheet contains complete details, photos, prices and explanations of all functions and controls.

EU-801A MDS Spec. Sheet contains complete details of all circuit cards and prices.

Circuit Card Spec. Sheet contains complete details and specs. on each circuit plus card prices.

another Heath/Malmstadt-Enke design

DIGITAL & ANALOG SYSTEMS

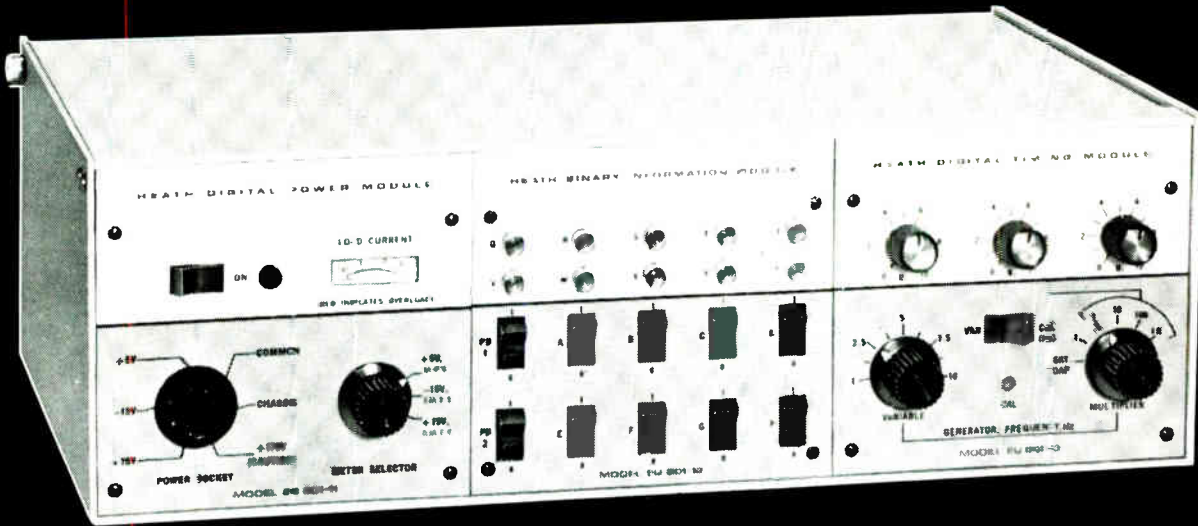

Systems, Instruments, Modules, or Circuit Cards

Heath "801" Series Digital Analog System Modules at \$435

A Unique Design-It-Yourself Approach To Digital Analog Instrumentation. The 301 Has Everything You Need To Investigate Digital Circuitry, Design Your Own New Circuits, Or "Customize" For Specific Functions As A Discrete Digital Instrument

General Features:

- Factory Assembled Digital Power Module, Binary Information Module, Digital Timing Module, and Plug-In Circuit Cards — each available separately if desired
- Unique System of Circuit "Breadboard-ing" for experimentation . . . fast, easy solderless connections
- Integrated Circuits
- TTL Integrated Circuit Logic
- Integral Time Base
- Binary Readout (optional digital readout available later)
- Integral Power Supplies
- Accepts Circuit Cards from Heath 805 Universal Digital Instrument

Now You Can Investigate:

- Counter Circuits
- Scaled Circuits
- Gating Circuits
- DVM Circuits
- Adders & Subtractors

- Integrators
- Digital-Analog Interface
- Special Circuits of your own design

Custom-Design Your Own:

- Counters
- Frequency Meters
- Digital Volt Meters
- Precision Timers
- Frequency Standards
- Operational Amplifier Systems
- Digital Analog Interfaces
- And Hundreds of other Digital & Analog Instruments

Recommended System (EU-801A as illustrated) Includes:

EU-801-11 Digital Power Module

Supplies all voltages necessary to operate the system, distributed by 6 pin connector. (+5, +15, -170 v.) Power also available on front panel at octal socket, at top of circuit cards, and at banana plugs. \$75.

EU-801-12 Binary Information Module

10 neon lamps and driver circuits; lamps light with application of logic 1. 8 SPDT switches and 2 SPDT spring return switches for binary information inputs. Connections for switches and lamps available at top of circuit cards. \$50.

EU-801-13 Digital Timing Module

Contains function generator and three controls for use with monostable and comparator circuits. Generator range, 0.1 Hz to 10 kHz, variable in 5 decade steps. External capacitor position for other frequencies to 100 kHz. Outputs: complementary square wave, complementary pulse, and ramp. \$60.

EU-801A Circuit Cards

Included are four NAND gate cards, two dual J-K flip flops, one dual monostable multivibrator, one relay card (contains 7 relays), one comparator/voltage to frequency converter card, one dual in-line IC patch card, two multiple connector/blank PC cards, one operational amplifier card with 1200 megohm input. Individual cards available, prices range from \$10 to \$40. (Note: many cards from the EU-805A U.D.I. can be used.)

EU-800-RC Three-Module Cabinet

Holds any three modules; has elevating support to allow unit to be tilted back for access to front panel controls or forward when "patching" circuit cards. \$20.

Ready For September Delivery:

Assembled EU-801A System (as described above) **\$435**
(prices of individual modules total \$468 if purchased separately).

Unique, flexible, extendable This new Heath/Malmstadt-Enke Modular System provides the first instrumentation package with the means to achieve virtually everything you wish in digital & analog circuitry. To investigate existing digital circuitry, just plug in the components required . . . to design your own special digital circuitry, just plug in the components required . . . if you wish to design your own digital or analog digital instrument, again it's just a matter of plugging in the components . . . it's all here in this new system. Factory assembled circuit cards plug into the chassis. Each card has a special connector board on top which features solderless connectors to accept ordinary hookup wire and component leads for fast assembly of special circuits (several hundred patch wires are included). Integrated circuits using TTL logic provide state-of-the-art electronics. This system is also open-ended . . . other modules and circuit cards will be available as technology changes so the system can be expanded to more and more applications. Information — Application Manual is included

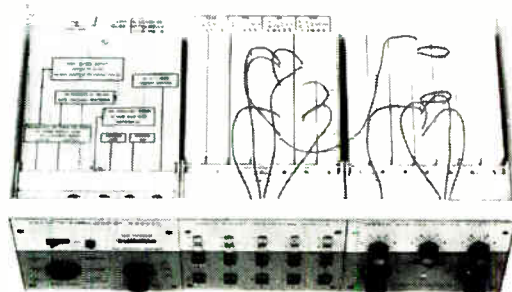

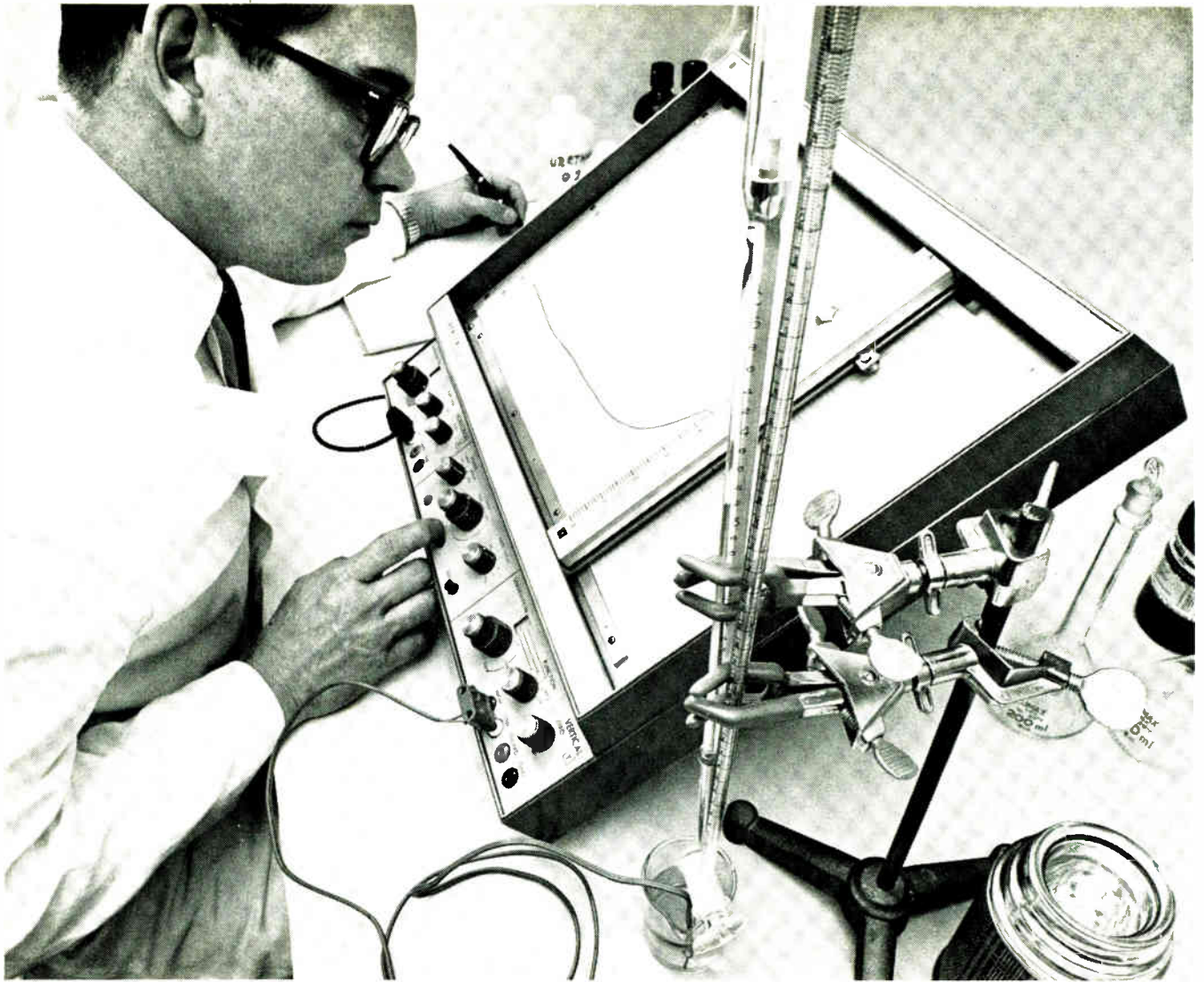

Recording transducer output with the new, ultra-sensitive Honeywell 560. Fully portable, it converts to rack mounting with ease.

This new Honeywell 560 is recording at $10\mu\text{v}/\text{inch}$ -- 10 times the sensitivity of any other X-Y recorder!

Our design philosophy on X-Y recorders boils down to this: first, you make one that doesn't break down. Then you give it state of the art electronics.

So, we borrowed the best mechanical concepts we developed a while back in our 550 recorder and incorporated them in the new 560. We used the same rugged, die-cast aluminum bezel and base, as well as the tough molded back cover that seals out dust and dirt, even when the recorder is rack-mounted. For smooth, quiet operation, we used the same precision-ground stainless steel carriage axis rods, ravel-free braided stainless steel drive cable, and snap-fit pen with non-clogging polished sapphire tip.

We topped off the mechanics with a sealed follow-up system, a maintenance-free fan vacuum system, and a standby position for easy paper loading. The result is an instrument built to last a long, long time. We know this because we subjected the 550 to more than 4.8 million cycles of constant operation before we designed the new 560. Its reliability exceeded our wildest expectations!

Now for the electronic sophistication: the 560 has ranges from $10\mu\text{v}$ to 50v per inch, permitting you to record just about any parameter you'll encounter without the need for additional signal conditioning equipment. It features accuracy of $\pm 0.15\%$, and its time base is accurate to $\pm 1\%$ of full scale. Frequency response is DC to 5Hz; input impedance is two megohms on all ranges, with provision for potentiometric operation of the nine most sensitive ranges. A solid-state chopper and all silicon solid-state circuitry mean high performance over a wide ambient temperature range. **The years-ahead 560 X-Y recorder** is another example of how Honeywell's broad line, backed by local sales and service, can provide the precise solution to your instrumentation problems. For full details on the new 560, call your local Honeywell Sales Engineer, or write: Honeywell, Test Instruments Division, P. O. Box 5227, Denver, Colo. 80217.

Honeywell

Honeywell engineers sell solutions

What is small, has stripes, and shrinks boards?

New CORNING[®]
C3 Resistor.

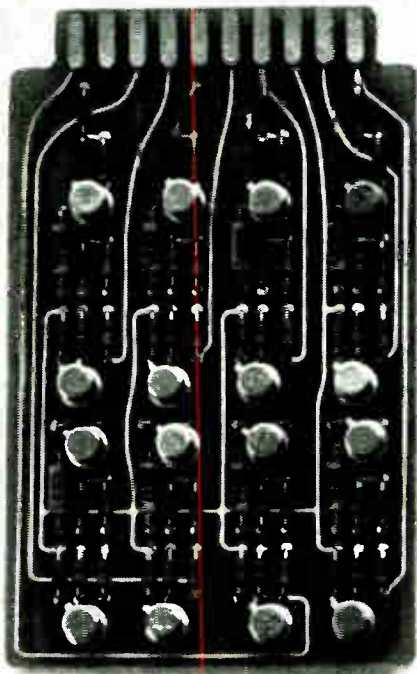

16 transistors
8 capacitors
52 C3 resistors
Actual size

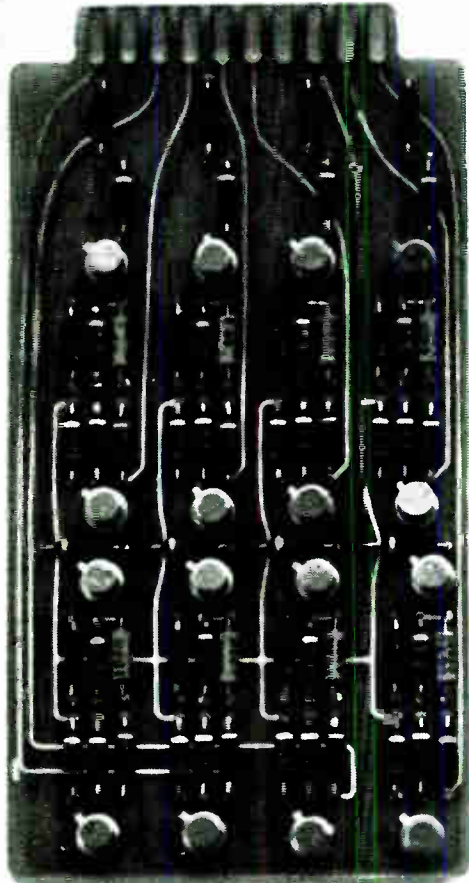

16 transistors
8 capacitors
52 RL07 resistors
Actual size

Now you can get 1/8 watt in a clean lead length of .150" and diameter of .066" maximum. That means a 35% reduction in board size for these eight Schmitt trigger circuits. Plus the proven stability of glass tin oxide film construction.

Put more circuit in the same space.
Or put the same circuit on a smaller board.

For specs and samples, write to Corning Glass Works,
Electronic Products Division, Corning, N. Y. 14830.

CORNING
ELECTRONICS

NEW EG&G PICOAMMETERS

A full line of low-level current measurement instruments

All EG&G Picoammeters include features others only talk about. Like the unique combination of precise accuracy and rapid, accurate calibration capability without resorting to calibration charts or resistor measurement. And, the all solid-state design, including a low level MOS FET input stage. What's more . . . you'll find an

EG&G Picoammeter to meet *your* needs and *your* budget. That's because EG&G offers the most complete line of low level current measurement instruments available. From high precision units or automatic ranging units, both complete with digital readout, to general purpose, manually-operated bench top models.

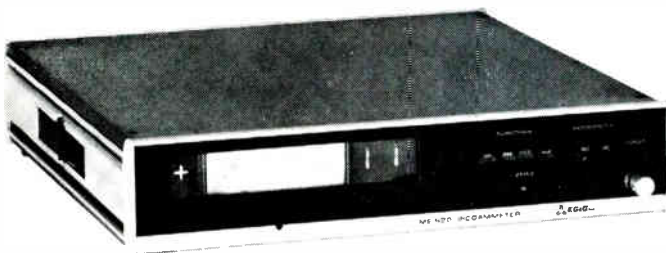
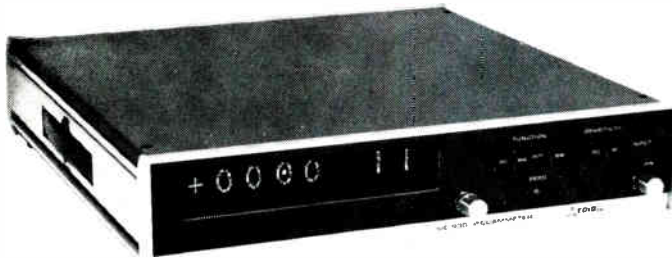
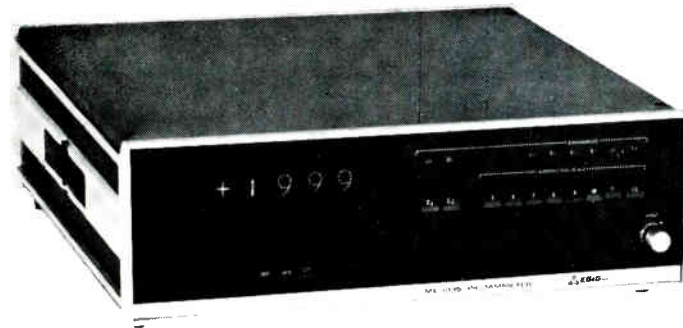

HERE ARE THE SPECIFICS ON FOUR OF THE MOST POPULAR EG&G PICOAMMETERS.

Model ME-1035, Precision Picoammeter — for Standards or Calibration labs. Current measuring range of 10^{-5} amps to 10^{-12} amps with 10^{-15} amps resolution. All solid state design with MOS FET input, temperature controlled feedback resistors for added stability, pushbutton range control, adjustable summing point voltage and current offset monitor, pushbutton controls for rapid internal calibration requiring no external standards or sources. Digital readout. Price: \$3,945.00

Model ME-930, Digital Picoammeter — for general lab work and automatic digital systems. Current measuring range of 10^{-11} amps through 10^{-2} amps full scale in 10 decade steps. A full digital picoammeter with automatic range changing capability and automatic polarity selection. All solid-state design with MOS FET input, remote function control and optional printer drive, digital readout of level and range. Price: \$3,575.00

Model ME-920, Automatic Range Changing Picoammeter — for general laboratory use and production line testing. Current measuring range of 10^{-11} amps through 10^{-2} amps in 10 decade steps. An automatic ranging picoammeter with remote function capabilities. All solid-state design, with MOS FET input and automatic polarity indication. Price: \$2,435.00

Model ME-705, General Purpose Picoammeter — for general laboratory use. Current measuring range of 3×10^{-13} amps through 10^{-2} amps in 22 steps (11 decades with X3 meter multiplier). A general purpose, manually operated bench-top picoammeter. All solid-state design, with MOS FET input stage. Price: \$560.00

For more complete details on the more complete line of EG&G Picoammeters, contact your local EG&G Products Division representative. Or, write EG&G Inc., Laboratory Products Division, P.O. Box 755, Goleta, California 93017.

EG&G
LABORATORY PRODUCTS DIVISION

**"Daddy told me,
'Order all of your
power supplies from
Acopian, my boy.
They'll ship any of
62,000
different kinds
in just
3 days!'"**

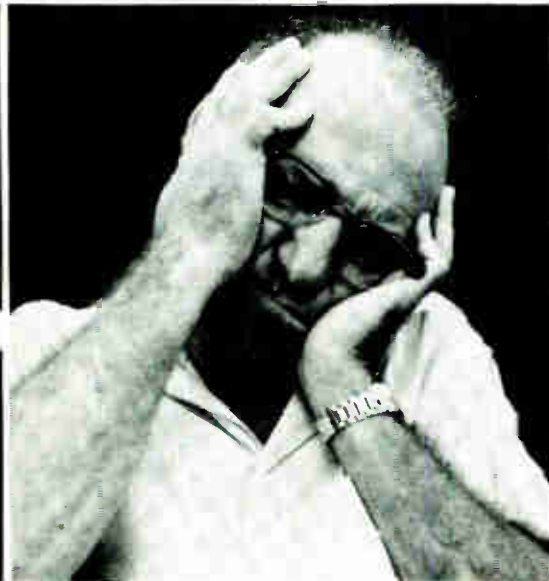
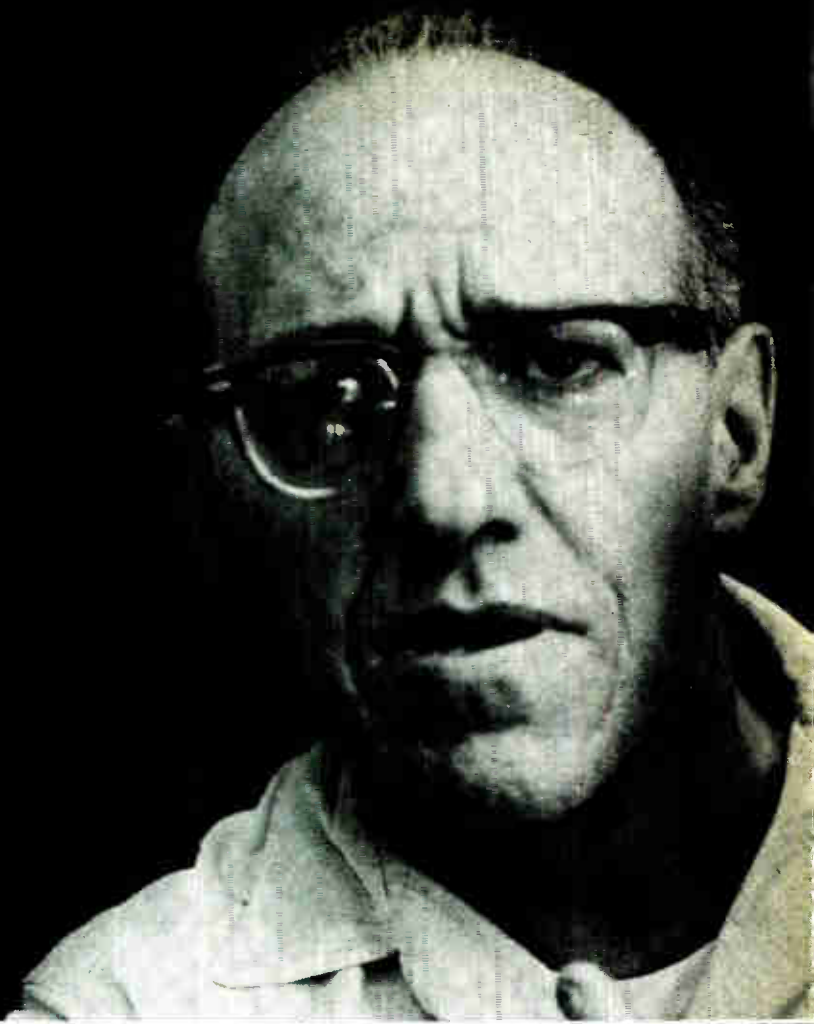

**"On my own initiative
I decided to order
from someone else."**

**"Six weeks later
the power supplies
had still not arrived."**

**"I now have the milk
run from Roxbury
to Hoag Corners."**

Circle 252 on reader service card



Next time you need power supplies in a hurry, contact Acopian and request a copy of our latest catalog. It lists 62,000 different AC to DC plug-in power supplies, any of which will be shipped to you in just three days! Choose the exact DC output you need. Singles or duals. Regulated or unregulated. Whether you need one power supply or several, your order will be shipped in just three days! That's our promise. For particulars, contact your local Acopian rep, call us at (215) 258-5441, or write to Acopian Corp., Easton, Penna. 18042.

Acopian

New Sony/Tektronix portable oscilloscope makes the going easier!



The new Sony/Tektronix Type 323 Portable Oscilloscope weighs 7 lbs, is 4 1/4 inches high, 8 1/2 inches wide and 10 5/8 inches deep. It operates from self-contained batteries for up to 8 hours. With this compact, lightweight instrument, a user may move from one remote application to another without concern for power connections. The Type 323 is especially attractive for maintenance of remote communications equipment, mobile communications equipment, aircraft instrumentation, marine instrumentation, production control equipment, etc. Batteries are rechargeable overnight (16 hours) by simply plugging the instrument into an AC outlet. The built-in charger will provide a fresh power source for use the next day. The Type 323 may also be powered from DC, 6 V to 16 V, up to 4.5 watts, and 90 to 136 VAC or 180 to 272 VAC, 48 to 440 Hz, up to 14 watts.

This solid-state portable oscilloscope also provides performance!

Bandwidth is 4 MHz at 10 mV/div deflection factor. For low signal level applications, 1 mV/div at 2.75 MHz is provided. Sweep rates are 1 s/div to 5 μ s/div, extending to 0.5 μ s/div with the X10 magnifier. A single control knob permits automatic or manual level sweep triggering, positive or negative slope. With no input the automatic trigger mode provides a bright baseline reference at all sweep rates. A 6 X 10 (1/4-inch div) internal non-illuminated graticule permits parallax free measurements.

The Type 323 is designed for severe environments. Performance specifi-

cations are maintained within an operating temperature range of -15° C to $+55^{\circ}$ C. It also passes shock, vibration and humidity tests which simulate environments "portable" instruments are likely to encounter.

Your Tektronix Field Engineer will demonstrate the performance of the Type 323 in your application at your convenience. Please call him or write: Tektronix, Inc., P.O. Box 500, Beaverton, Oregon 97005.

Type 323 Portable Oscilloscope (including batteries) \$850

U.S. Sales Price FOB Beaverton, Oregon



Tektronix, Inc.

committed to progress in waveform measurement

Probing the News

Computers

Federal libraries cast a long shadow

Electronic systems being pioneered by Government institutions to cope with an information flood may lead to nationwide communications networks

By Paul A. Dickson

Washington regional editor

Washington wags have long claimed that the principal product of the nation's capital is paper. Only those civil servants already buried under mountains of reports, periodicals, and publications of all sorts would deny that this is an overstatement, but the fact remains that Federal agencies do place a tremendous importance on printed material.

Keeping track of all this paper has always been difficult, but now, in an age when information is proliferating at an alarming rate, the job has become monumental. And the institutions charged with the task—the Library of Congress, the National Library of Medicine, the National Archives, the National Agricultural Library, and the Smithsonian Institution—are turning to electronics to cope with the flow and to provide access to stored information.

The trend to electronics is recent, but, as with the generation of printed matter, the pace is stepping up. New projects and systems are being announced regularly. And changes in the practices of the national repositories are causing corresponding shifts in the general field of the library arts. Local libraries are beginning to do parallel work on their own.

New role. Paul R. Reimers, director of the information services office of the Library of Congress, predicts that over the next few years there will be massive development in the field of automated libraries, meaning a sizable new

market for computers and other electronic hardware. He notes that librarians are already adding terms like "network," "regional center," and "automated data relay" to their working vocabularies. "A basic change is taking place," Reimers declares. "Automation is transforming the library from a storehouse to a communications center."

Reimers believes that the major advances being made by the Fed-

eral libraries will be followed on the local level, and that the Washington programs should therefore be viewed as harbingers of a widespread changeover. He cites a meeting held last year by the Library of Congress for computer manufacturers. Library officials told the industry what they were planning in the way of services, and manufacturers are now working on software to implement such services

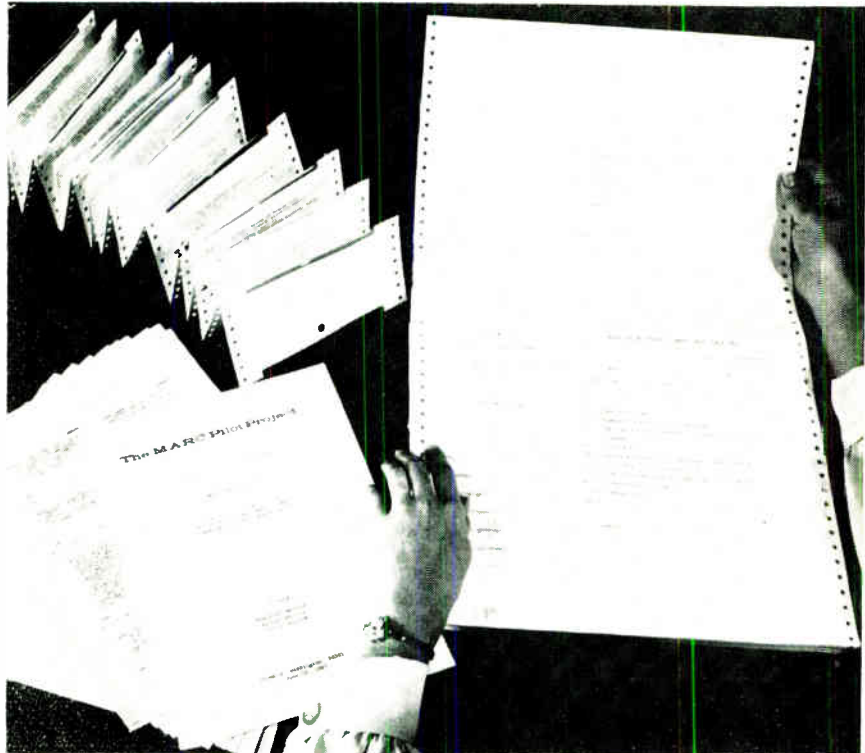

Versatile. The Library of Congress' machine readable catalog format can be used to produce such items as the book catalog seen at left, catalog cards, and worksheets with searching slips seen at the right.

REMOTE CONTROL SWITCHING WITH AUDIO SIGNALS



A single pair of wires, or a leased telephone line, can carry the audio signals for a complete control system.

For inaccessible areas or mobile installations, a radio transmitter and receiver system can carry the signals.

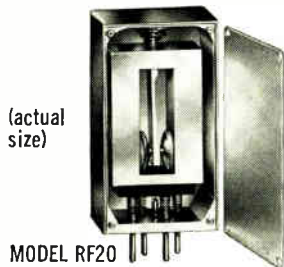

(actual size)

MODEL RF20
contactless resonant
reed encoder/decoder
.395 x .620 x 1.100

An audio tone can be generated by an electronic oscillator or resonant reed encoder circuit, then transmitted by wire or radio. The tone activates a resonant reed relay to perform a control function.

Bramco reeds permit over 100 selective control frequencies within the 67 to 3000 Hz. spectrum. This is assured by: (1) the narrow response band-width of about 1% for decoders and (2) the high accuracy of Bramco reed encoders (1/10 of 1% of design frequency).

A big advantage of reeds in control switching is that they are ideally suited for simultaneous and sequential coded tone systems. The actual number of control functions possible in such a system is virtually unlimited. For example, over 3300 individual control functions are possible with only 16 frequencies coded sequentially in groups of three.

Compared to other types of tone filters, resonant reeds are small and inexpensive. They give more control functions per spectrum, per size, per dollar.

If you work with controls that select, command, regulate, or indicate, you should know how it can be done with audio signals. We custom design and stock a broad line of encoder/decoder components and modules. Bramco also custom designs LC filters from 0 to 200 KHz.

For literature write Bramco Controls Division, Ledex Inc., College and South Streets, Piqua, Ohio, or call 513-773-8271.



**BRAMCO CONTROLS DIVISION
LEDEX INC.**

College and South Streets, Piqua, Ohio 45356

throughout the country.

Medical pioneers

The National Library of Medicine, a unit of the National Institutes of Health, has pioneered library-based information-retrieval systems. In 1964, the library began operating a computer-based system called Medlars (for medical literature analysis retrieval system). Medlars has had a strong impact on the library sciences—and on electronics as well—for it's the first system to employ a high-speed electronic phototypesetter.

The library is continually expanding Medlars. Earlier this year, for example, the main library in Bethesda, Md., was electronically linked through IBM 1050 equipment to two remote information centers at the University of Colorado in Boulder and Harvard University in Cambridge, Mass. And last month, the library announced the award of a \$2 million contract to the Computer Sciences Corp. of Los Angeles for a three-year program to upgrade and expand the system. In addition, the library plans to tie an IBM 360/50 computer into the new version of the system.

In handling its basic task of providing fast access to the medical and biological literature of the

world, Medlars currently performs three major functions:

- It compiles and prints the Index Medicus, a monthly listing of medical references from journals throughout the world. An average issue contains references to about 14,000 new articles.

- It draws up bibliographies for doctors upon demand. In other words, when presented with a complex medical question, the system will produce a list of citations regarding the subject from the world's literature.

- It turns out recurrent bibliographies for medical specialists. A monthly is produced on rheumatism, for instance, and a quarterly index is prepared on artificial kidneys.

In addition, Medlars is cranking out an increasing number of card lists and catalogs of medical literature from its base of some 750,000 references.

The expanded system, to be called Medlars 2, will be, claims Computer Sciences, "the most sophisticated total management system yet developed for third-generation computers." Officials at the library are a bit more modest in their assessment, maintaining only that Medlars 2 will be the most advanced library-based computer sys-



Congressional records. Tape drives are integral part of computer center at Library of Congress, which is working on machine readable catalog format.



Getting the word. The National Library of Medicine, which pioneered library-based data retrieval systems built around computers was also the first to use phototypesetting equipment like that shown above.

tem in actual operation.

On-line library. The library's project officer for Medlars 2, Barbara Sternick, explains that the new system will be implemented in two steps. By the middle of next year, the system's special medical subject headings vocabulary will be expanded to include new terms and some "dictionary" words; this last will permit addressing in terms close to conversational English. Another first-level project will be to adapt the system to print out 150-word abstracts of medical articles.

In the second stage, which will be completed in 1970, the system will go to on-line operation. Remote cathode-ray-tube displays will be used for reviewing material, and on-line indexing, cataloging, and corrections will be done by keyboard operators. Searches for material will be conducted on-line, and the system will "remember" all queries to speed retrieval the second time around.

Modules containing data on the rapidly expanding fields of drugs and chemicals, and the system will get the capability to produce graphic images—chemical structure diagrams, for example.

The complete Medlars 2 will control the flow from the moment a work is ordered, through the nor-

mal library functions of indexing and cataloging, to its appearance as a reference in a library publication or as the object of a special search. The system will be busy; library officials predict that Medlars 2 will contain more than 2 million items of information by 1972, and will process more than 26,000 bibliographies a year.

Offspring. In assessing the effect of Medlars on electronic libraries generally, Scott Adams, deputy director of the National Library of Medicine, observes that "Medlars computer tapes are already being used in medical libraries in Sweden and Britain," and that Japan, Canada, Australia, France, and Germany have expressed an interest in acquiring the tapes. Also, the World Health Organization of the United Nations is having two of its technicians trained in Medlars techniques. Adams further states that Medlars development has helped foster such computer-based systems as the National Parkinson's Disease Information Center at Columbia University, the Brain Research Information Center at the University of California at Los Angeles, the Sensory Perception Information Center at Johns Hopkins University and the Visual Perception Information System at

if we haven't
made it . . .
nobody has
asked for it

We make not only a wide variety of standard cable constructions, including all the standard RG/U Coaxial cables, but also a tremendous number of special constructions to customers' specifications. These special *Flexlead* cables are precisely engineered to meet the exacting requirements of high and low temperatures, corrosive atmospheres, repeated flexure, abrasion, excessive corona, weathering, and many other severe conditions. Whatever your requirements, Markel will make a cable to meet them. In fact, the chances are good that we've already made one like it . . . and that could save you both time and money! Your letterhead request will bring a copy of our complete *Flexlead* catalog.



L. FRANK MARKEL & SONS, INC.
Norristown, Pa. 19404 • Phone: 215/272-8960
INSULATING TUBINGS AND SLEEVINGS
HIGH TEMPERATURE WIRE AND CABLE

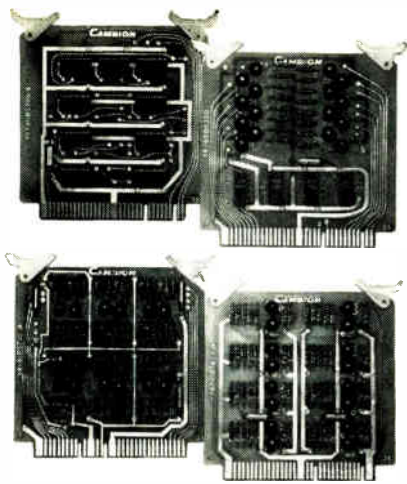

You've got it made with Cambion® Logic Assemblies

Difficult digital application? Noisy environment? Need high speed or a large variety of functions? Ask for CAMBION DTL, TTL or HTL logic assemblies. CAMBION gives you more functions per card and all cards are compatible.



Choose from over 200 assemblies with high package densities and 70-pin input/output capability. That's twice the number of any competitor, and CAMBION assures you the lowest cost per function. The complete line includes power supplies, card files, drawers . . . available off the shelf, in the widest variety.

For more information on CAMBION's IC assemblies, contact: Cambridge Thermionic Corporation, Digital Products Division, 447 Concord Avenue, Cambridge, Massachusetts 02138. Phone: (617) 491-5400.

© REG. U.S. PAT. OFF.

CAMBION

Standardize on CAMBION . . .
21,541 guaranteed electronic components

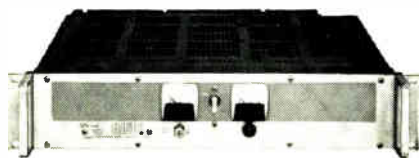

... the National Library of Medicine is studying networking concepts ...

Harvard University.

Adams notes that the research and development arm of the National Library of Medicine is studying networking concepts with an eye to establishing a national network of computer-based operations. The staff, he says, is looking into automated problem solving and such advanced concepts as remote browsing and high-resolution visual transmissions.

Leading the way

Of the several automation projects now being conducted by the Library of Congress, the one that will have the most immediate impact on libraries throughout the U.S. is called Marc, for machine readable catalog. The program was launched in 1966 when 16 libraries around the country were sent magnetic tapes of the English-language monographs received by the Library of Congress. After making some format changes, the library recently announced that Marc tapes will be available to any library that wants them starting this fall. Reimers expects about 100 libraries to subscribe initially.

The modified tapes, produced by an IBM 360/30 computer, will be sent each week to participating libraries. During the pilot operation, Marc tapes, together with other simple software, were used to produce such items as catalog cards, specialized listings and bibliographies, labels for book cards, card pockets and spines, and new catalogs. The Washington State library produced catalogs for smaller public library systems in the state and Yale University's library used the tapes to alert faculty members to new titles in their fields.

Reimers notes that Marc cataloging is now being applied not only to books and such, but also to maps in the library's collection, and similar handling is slated for the library's comprehensive collections of recorded folk music and photographs, as well as the 624,000 periodicals in the library's collection. The Smithsonian will use Marc for similar applications. And Reimers says the British and

Canadians are considering the Marc format for comparable programs. Eventually, he says, Marc will be used by computer-equipped regional libraries to serve smaller local branches.

United front. Last month, the National Library of Medicine and the National Agriculture Library, along with the Library of Congress, announced the adoption of the standardized Marc communications format.

Under another Library of Congress program, the Hamilton Standard division of the United Aircraft Corp. has just completed a study of ways to automate the library's central bibliographic facility. After the study has been evaluated, system specifications may be drawn up and a request for hardware proposals issued. The library, though short of funds, hopes to have the system installed and debugged by 1970. Reimers contends that massive automation schemes such as this one are now feasible because of new terminal devices and the large memory capacity of third-generation data

Anarchy in the archives

Because of the trend to the wholesale use of computers, serious information retrieval problems are cropping up at the National Archives and other record-keeping institutions. The fact that more and more data on matters of scientific and historical importance is kept on magnetic tape is at the root of such difficulties.

Tape, says one specialist, is not a stable archival medium. It must constantly be rewound and cleaned, and it doesn't last as long as paper. An even more serious drawback involves tape compatibility. The National Archives, for example, is getting tapes from all kinds of computers in a variety of formats. "What happens in 1985 when a researcher wants data on the 1960 census, and the only available IBM 1401 is in the Smithsonian's computer collection," asks an official. Because of such problems, a new Federal task force is checking tape-conversion schemes.

A FET FOR UHF

The 2N5397 has guaranteed 450 MHz performance
... Power gain 15 dB min...NF 3.5 dB max.

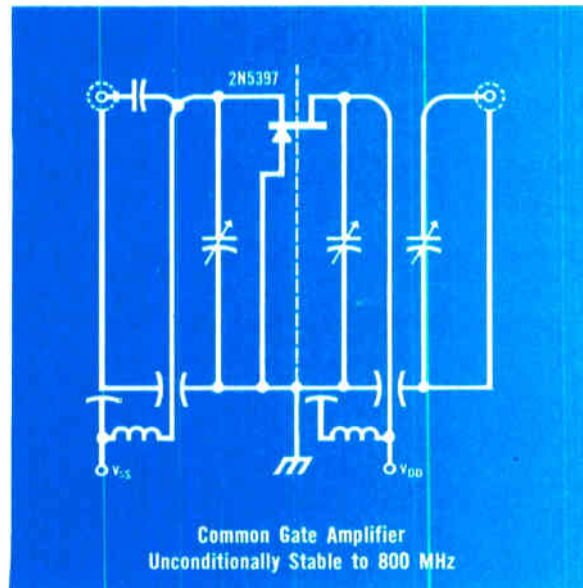
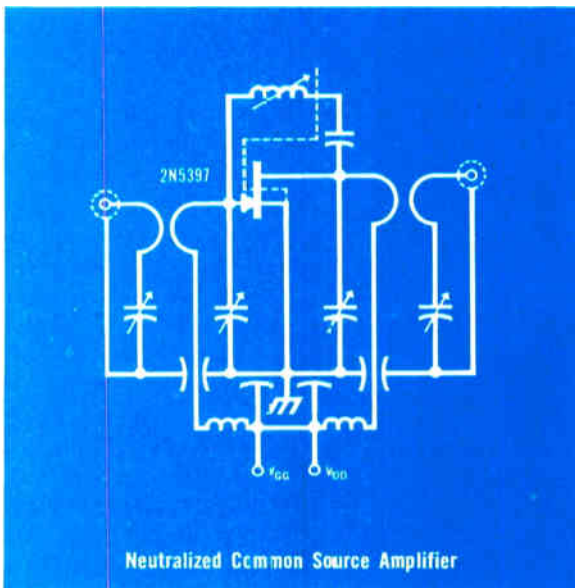

High g_m — 6000 μmho min — and low C_{rss} — 1.2 pF max — combine to give these results in a neutralized common source amplifier. But if you're against neutralizer twiddling then design a common gate circuit. With the 2N5397 it'll be unconditionally stable up to 800 MHz and, at 450 MHz, still have 13 dB power gain with NF less than 4 dB. Used either way — CS or CG — the FET's "square law" character reduces inter- and cross-

mod products... better than any other active device.

We also make other RF FETs... 2N3823; 2N4220-24; 2N4416... some industrial types and a power FET or two. We've crammed all this data plus more detailed specs on these two CS and CG circuits into an "RF FET Data Packet" ... write for it.

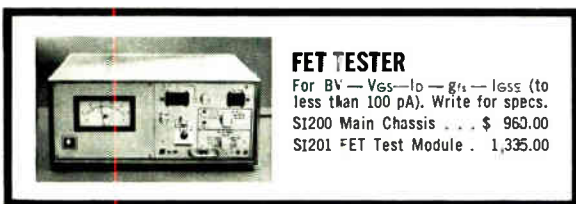

Siliconix Incorporated

1140 W. Evelyn Ave. • Sunnyvale, CA 94086
Phone (408) 245-1000 • TWX: 910-339-9216

... the Library of Congress keeps tabs on automation programs in its field ...

processing equipment.

Among other projects at the Library of Congress is a study of the use of punched cards as "call slips" in the library's manuscript division. The cards would aid in locating manuscripts, keep track of them by computer, and compile statistics on the relative use of different sources.

Also, the library has just selected RCA from among seven bidders to build a system that will automatically produce the almost universally used Library of Congress catalog cards (some 75 million are sold by the library each year). The contract will probably call for a spectra 70/45 computer and a Videocomp crt-driven phototypesetter.

Finally, optical scanning and sorting equipment, supplied by Radiation Equipment Inc., will be installed at the library this summer to read, sort, and record orders for catalog cards.

Paper chase

The National Archives and Re-

cords Service is another library of sorts that's looking to electronics for help. Well it might; the service has the formidable task of keeping track of the records of the U.S. Government. Besides the National Archives, with its 900,000 cubic feet of historical records in the Capitol, the organization is responsible for 14 regional record centers plus the various Presidential libraries containing the papers of Franklin D. Roosevelt, Harry S. Truman, and Dwight D. Eisenhower.

At present, the National Archives is working with nine institutions that collect personal papers or maintain archives. The venture, dubbed Spindex (for selective permuting index), centers on a computer program for indexing manuscripts and papers. Frank G. Burke an information-retrieval specialist at the National Archives, explains that Spindex will permit information to be examined in every conceivable manner, as the program lists all the key words in the de-

scription of a document.

If all the institutions that store historical documents use Spindex—and the indication is that most will—they will have access, through the computers, to each other's collections. The Smithsonian will use Spindex to catalog its scientific manuscripts and the Library of Congress is planning to go along with all its manuscripts, as are various historical societies, museums, and universities.

Burke, like others in this field, is talking about a network: "Our regional record centers are tied in with 10 General Services Administration data centers, centers that could be used to question a central data bank about the location of a certain document." He envisions a time when a professor in California will interrogate a Washington data bank through a GSA center about a historical document that will be located for him in Arizona. And he sees no reason why such a central bank could not be hooked up with university computer systems to provide a nationwide research facility.

Keeping tabs. The Library of Congress maintains a file on automation programs in the library field. This file, which answers to the acronym Locate (for Library of Congress automation techniques exchange), is used to keep libraries abreast of developments and to keep those working on new systems informed about what their colleagues have tried, are working on, or are planning.

Locate now contains reports, manuals, flow charts, and other documents on several hundred systems around the world, but Reimers warns that the file may not be an accurate barometer of activity since many current projects may not have yet been reported. However, he believes Locate will grow rapidly over the next few years because the library is now seeking out information on new systems instead of waiting for it to come in over the transom. Also, of course, there should be many more launched in the near future.

Reimers isn't planning to let documentation fall behind, either. He plans to convert Locate's citations, index terms, and abstracts to a machine-readable form for fast access.

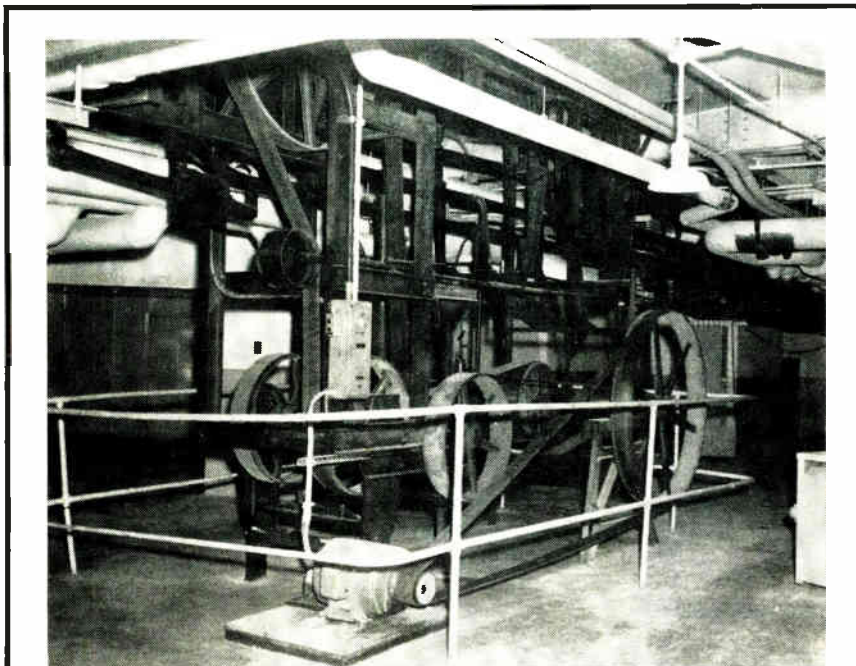

Departed past. Automation's nothing new for the Library of Congress. When it opened for business in 1897, there were a number of ingenious systems to get books around the building in jig time. The apparatus shown above was called the "Capitol Carrier." Until earlier this year, it served faithfully, shuttling books between the library proper and Congress. But the Capitol Carrier—one of the first setups to which the term automation was applied—is finally making way for progress.

Semiconductor firms' captive lines capture defense contractors' fancy

Increasingly stiff reliability requirements induce military systems suppliers to establish their own production enclaves on the premises of components makers

By Peter Vogel

San Francisco regional editor

For the past two months, in sequestered areas at the Semiconductor division of the Fairchild Camera & Instrument Corp. and at Texas Instruments Incorporated, two transistor assembly lines have been operating under the direct supervision of the Sandia Corp. Sandia owns the equipment, and the semiconductor makers supply the labor. This sort of arrangement is becoming less and less uncommon in the freewheeling semiconductor industry. However, the relationship of such operations to such touchy subjects as radiation hardening and missile reliability makes buyer and seller alike somewhat leery of detailed discussion.

The function of the two new lines, says a Sandia source, will be the application of new or improved assembly techniques to prevent repetition of circuit failures. He adds that these efforts will be supported by separate research and development work in assembly techniques.

Division of labor. Although all R&D will be done at Sandia's Albuquerque, N.M., headquarters, the assembly work will be done on either the Fairchild or TI line. These companies will also supply the dice. The cost of the Fairchild line, says a Fairchild official, is a one-time item that includes the work space and bonding and packaging equipment plus all required testing gear. Beyond the initial investment, Sandia is charged on a time-plus-materials basis; Fairchild gets a guaranteed minimum fee.

Under a contract of finite duration, Fairchild is responsible for maintenance costs on equipment,

and it pays the wages of the assembly personnel. Sandia stipulates that employees on its facility work there exclusively and that they be of high caliber and "highly motivated."

Six transistor chips, especially designed by Sandia for radiation resistance, are being manufactured and assembled under close controls by Fairchild and TI on the Sandia lines. The devices are to be used in Atomic Energy Commission projects and on other high-reliability programs underwritten by the Government.

The lines give Sandia exceedingly accurate wafer-to-package

quality control. Sandia keeps comprehensive records on each chip throughout assembly to allow evaluation of procedures and correlation with circuit reliability.

Sandia calls such operations "captive assembly lines." The products from them are exclusively the company's and any process developments and patents also belong to Sandia. Fairchild and TI may not sell Sandia circuits to other buyers—as the Autonetics division of the North American Rockwell Corp. could when it set up earlier "controlled lines" in its own plant and elsewhere for production of high-reliability components for the Min-



Women's work. Captive, or controlled, semiconductor assembly lines like this one operated by Texas Instruments for Autonetics needs in Minuteman program are increasingly common in the field.



Couch 2X 1/7-size relays meet MIL-R-5757D/19 in 1/25th of a cubic inch

The new, third generation Couch 2X relays solve switching problems where space and weight are critical. Thoroughly field-proven in electronic and space applications. Relays are delivered *fully tested*. Additional screening tests available at your option.

	2X (DPDT)	1X (SPDT)
Size	0.2" x 0.4" x 0.5"	same
Weight	0.1 ox. max.	same
Contacts	0.5 amp @ 30 VDC	same
Coil		
Operating Power	100 mw 150 mw	70 mw 100 mw
Resistance	60 to 4000 ohms	125 to 4000 ohms
Temperature	-65°C to 125°C	same
Vibration	20 G to 2000 Hz	same
Shock	75 G, 11 Ms	same

Broad choice of terminals, coil resistances, mounting styles. Write for detailed data sheets.

RUGGED ROTARY RELAYS  Dynamically and Statically Balanced

Couch
1894

COUCH ORDNANCE INC.

3 Arlington St., North Quincy, Mass. 02171
Area Code 617 CYpress 8-4147
A subsidiary of S. H. COUCH COMPANY, INC.

... radiation tolerance is still tied to tight controls on assembly line ...

man 1 and 2 projects.

New Directions

Sandia's reasons for setting up the two lines have implications for the entire semiconductor field and may herald significant changes in the industry's response to demands for high-reliability devices. The Navy, for example, may soon request captive lines for hardware for the fleet ballistic missile program. And the Space and Information Systems division of the Raytheon Co., which is building the guidance computer for the Navy's Poseidon missiles, will use captive lines to assemble a special NAND gate, a J-K flip-flop, and dual four-input line receiver. Other captive lines to be purchased by Raytheon will turn out more than 20 kinds of integrated circuits and transistors. The Lockheed Missiles and Space Corp., the prime contractor for Poseidon, is reliably reported to be soliciting bids from four companies on captive lines for dielectrically isolated circuits.

In an effort to get in on Raytheon's business for bipolar dielectrically isolated devices, Fairchild, TI, the Philco-Ford Corp.'s Microelectronics division, Motorola, Inc., and Radiation Inc. are competing to set up one or more captive lines. Fairchild is supplying one of the circuits from a regular line.

Big time. Chaz Haba, Fairchild's director of aerospace and defense marketing, says the company may set up as many as six to 10 lines in the next year or so. Fairchild has a whole room, now empty except for the Sandia line, set aside for such operations. Haba predicts that some hybrid work will also be done on captive lines, adding that anyone who wants high-reliability devices will go to captive lines from here on out. He points to the ever-increasing proportion of the military budget going into missiles, where a "reliability and damn the cost" attitude prevails, as an indication of captive lines' potential.

Missile components, with their one-shot nature, are prime targets for captive lines, especially with the tightening in Government re-

liability specs. But circuits that will operate in space in the Van Allen radiation belts, in an environment contaminated by a nuclear explosion, or near a nuclear reactor or source of isotope radiation, must also be hardened. David Myers, radiation effects program manager at Fairchild, says that only recently did state-of-the-art work in semiconductors permit exact specifications to be written for reliability in the little-known area of fast-neutron irradiation. Post-irradiation specs, he says, have, until recently, been subject to negotiation and were done on a "best-effort" basis. Currently, he adds, Government policy has hardened to the point where radiation tolerance isn't considered open to negotiation.

Circuit-design advances in the past nine-months, says Myers, have shown that certain variables can be controlled at the wafer stage to enhance radiation tolerance. Items: voltage requirements must be minimized; dielectric isolation must be used to control spontaneous generation of photocurrents; and supply currents must be limited by using thin-film resistors in collector legs. But even when the circuit designer has done his best, radiation tolerance and reliability are still closely tied to tight controls on the assembly line.

Buyers and sellers

The captive assembly line idea, which stresses these strict controls, is thus becoming widely accepted among both buyers and sellers of semiconductors. The user gets assurance of high reliability; the vendor gets a guaranteed customer for devices with high unit costs.

RCA hasn't done any captive-line work, but Frank Rohr, manager of marketing administration at the Electronic Components division, says, "If someone came to us about setting up a captive line we wouldn't necessarily say no. You get a certain amount of guaranteed business without any of the responsibility for reliability." In Dallas, TI is running the line for Sandia along with operations that supply "bits and pieces" of Lockheed's

semiconductor requirements for Poseidon and Autonetics' Minuteman needs. The TI lines differ from others in being strictly assembly areas. The front-end work and diffusions are done in a laminar-flow clean room that serves as a sort of central clearinghouse for all circuits produced by the company. Proposals for captive lines from anyone working on high-reliability programs, says a TI official, would be welcome.

In southern California, Jack Hirshon, division manager of Hughes Semiconductor, says his company would be interested in selling captive lines if the volumes were high enough. Hughes has apparently had several attractive offers; it's considering at least two proposals to set up captive lines. Hirshon warns that the customer must be willing to pay the "substantial" costs involved in setting up a line. Radiation Inc. is also negotiating to build a captive line for missile components, but won't comment, because, according to a company spokesman, "the question is too loaded politically."

Costs plus. That spokesman was probably thinking of costs and profits. The costs for a customer who wants highly reliable devices from a captive line are, on the evidence, astronomical. But circuits intended for extremely critical functions have always come high. One Fairchild official estimates that of every 10,000 circuits purchased by the AEC and comparable agencies, only 500 ever pass final acceptance testing and specification. An official in the

Navy's Special Projects Office, which administers the Polaris and Poseidon programs, says: "Costs will probably be only marginally greater because of the greater control and checking in the captive-line process."

But cost estimates by IC manufacturers aren't quite so comforting. Glenn Penisten, manager of business development at TI's Components group, says it's axiomatic that a special line can't operate as efficiently as a conventional production setup. He adds, however, that the additional costs may be worthwhile because of the reliability gains built into systems with devices made on captive lines.

What's more, programs for which captive-line production will be used are generally not cost-conscious propositions. Reliability is the single best consideration. Probably because of the costs, the profits, and the "politics" involved, no supplier or contractor is willing to comment in depth on agreements for setting up lines. The semiconductor houses bidding on the Raytheon captive lines even refuse to spell out such details as whether they plan to lease or sell assembly equipment to the contractor. However, Chauncey N. Dewey, manager of fleet ballistic missile programs at Raytheon, has given some indication of what he expects from captive-line vendors soliciting work on Raytheon's Poseidon requirements.

Stressing that Sandia captive lines usually build products of Sandia design, Dewey says, "Raytheon tends to think of the captive line more in terms of workmanship and/or quality assurance than as a device for creating our brainchildren."

Get-together. Raytheon, he says, called in vendors last December, told them what was wanted, and asked for proposals and comments. The key to the captive-line idea, Dewey told the vendors, is the need for large numbers of parts over long periods of time. These factors, he said, make it possible to set up equipment, train personnel, and maintain the skill levels needed. In addition, Dewey wants a separate plant area where Raytheon will receive electronically and visually presorted dice, and be able to assemble, test, and sort



Fan. Raytheon's C. N. Dewey likes the concept of captive assembly lines.

Bulova can supply the crystal you need



to match your specs!

Many years of supplying crystal control units for the most advanced military and space programs enable Bulova to offer a full line encompassing virtually the entire frequency spectrum—2 kc to 125 Mc for oscillator and filter applications. We can supply every type of packaging—including koldweld and glass sealed. Our military crystals meet latest MIL-C-3098D specifications. All reasons why you should make Bulova your single source of supply.

HIGH PRECISION GLASS SEALED CRYSTALS 1 Mc to 125Mc. Available in vacuum sealed, glass enclosures of the HC-26/U and HC-27/U type.

Example: Precision SSB Crystals

Frequency: 1 Mc to 5 Mc
Holder: HC-27/U
Tolerance: $\pm .0025\%$ from -55°C to $+90^{\circ}\text{C}$, or to specification
Aging: 3×10^{-8} per week after one week stabilization at 75°C



KOLDWELD SEALED CRYSTALS—low aging, high reliability, 1 Mc to 125 Mc. Now available in TO-5, HC-6/U and HC-18/U type cans sealed by the koldweld process to eliminate effects of heat and to reduce contamination.

Example: TO-5

Frequency: 15 Mc to 125 Mc
Tolerance: $\pm .0025\%$ from -55°C to $+105^{\circ}\text{C}$, or to specification
Aging: 1×10^{-7} per week after one week stabilization at 75°C



Write or call for specifications on Bulova's complete line of crystals. Address: Dept. E-17.

BULOVA

FREQUENCY CONTROL PRODUCTS

ELECTRONICS DIVISION OF BULOVA WATCH COMPANY, INC.

61-20 WOODSIDE AVENUE WOODSIDE, N.Y. 11377, (212) DE 5-6000

**ECCOMAX HI-Q
LOW-LOSS
DIELECTRICS**

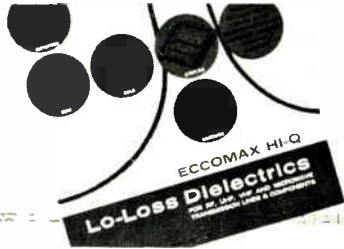

18 low loss systems are described in new folder and chart. Casting resins, impregnants, coatings, adhesives, rod & sheet — some foams — some Hi K — all with dissipation factors below 0.001. For RF, UHF, VHF and microwaves — capacitors, coils, etc.

Circle 516 on reader service card

**PLASTICS / CERAMICS
for ELECTRONICS
CONDENSED CATALOG**



New folder describes product lines—casting resins, adhesives, foams, sheet stock, coatings, silicones, microwave absorbers, anechoic chambers, shielding materials, etc. Post card included for obtaining more details.

Circle 517 on reader service card

**ECCOAMP
ELECTRICALLY CONDUCTIVE
ADHESIVES & COATINGS**

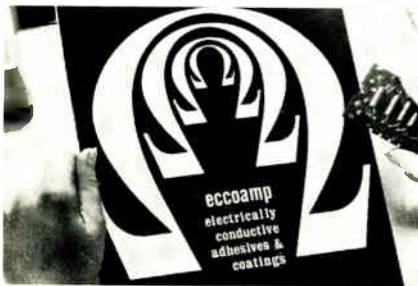

New four page folder describes materials from 0.0001 to 100 ohm-cm. Adhesive pastes to replace hot solder, thin liquids, silver lacquer in aerosol spray, lossy coatings, etc.

Circle 518 on reader service card

Emerson & Cuming, Inc.



**CANTON, MASS.
GARDENA, CALIF.
NORTHBROOK, ILL.**
Sales Offices
in Principal Cities

EMERSON & CUMING EUROPE N.V., Oevel, Belgium

again. But Dewey hasn't closed the door on starting with the unscribed wafer; nor has he decided whether burn-in, sealing, and testing should be done on the captive line.

The way it looks now, he says, the semiconductor manufacturer will supply equipment, space, and people, and write off overhead in the usual way. There could also be a buy-back clause in case a vendor had acquired an expensive piece of equipment for the contractor's line and couldn't use it because of program cancellation.

From its experience on the Apollo guidance and navigation computer, says Dewey, Raytheon found that most failures were related to assembly defects: poor bonds between chip and case, poor wire-chip bonds, poor wire-post bonds, scratches, and related difficulties. Components for the Apollo computer, which were made on a Philco-Ford captive line, also showed that tight material specifications and stringent visual inspection on the production line were necessary to achieve high reliability. Because of this experience and a check of Sandia's program with Fairchild and TI, Raytheon decided to go with the captive-line idea for Poseidon components.

The success of the captive-line approach to high-reliability assembly, says Dewey, will be proven by the narrow distribution of electrical characteristics in devices from the lines. There may be, he concludes, a dramatic increase in system reliability because of the captive line concept.

Nobody's perfect

What does this all mean for the semiconductor industry? Although most captive-line managers are talking about 100% reliability or failure rates in fractions of 1%, it seems perfectly obvious that there will always be a small number of circuit failures. But, as methods of reducing failure rates become more effective, says Fairchild's Myers, it can be reasonably expected that the general level of reliability in all circuit applications will be pushed upward. And where only critical missile components are now getting the captive-line treatment, it may soon be that important ground and avionics systems will be candidates for the kid-glove approach.

Myers believes that if the captive lines prove their worth in reliability enhancement, more and more circuits will be produced in this way.

Raytheon's emphasis on captive lines will have certain other industrywide implications. Says Dewey: "Under the old rules, vendors might have supplied one or two out of perhaps 25 to 30 semiconductors for a specific project. Now, one firm will tend to supply most or all of the IC's or discrete components." But, Dewey is quick to stress, captive-line production of Poseidon computer circuits won't mean the end of second sourcing either as a method of ensuring circuit delivery or as a means of cutting cost through competition.

Captive lines, he thinks, will be concentrated in houses with the broadest product lines. He mentions Fairchild, TI, and Motorola—but doesn't include Raytheon's own semiconductor operation—in the list of houses that could get a share of the captive-line business. Raytheon Semiconductor's line doesn't include the chips that would be put into such a line. Says a Raytheon Semiconductor official: "We would have had to buy the chips to put into the captive line for Radiation Inc.; we would have lost money."

In the cold. Raytheon Semiconductor's virtual exclusion from the captive-line business could indicate what small- and medium-sized firms will experience under the "new rules" established by Raytheon's Space and Information Systems division. Not only will the smaller companies lose the opportunity to participate in the captive-line contracts, but they'll also be denied the experience that the larger companies will get from this form of subsidized research on assembly techniques.

An official with the Polaris-Poseidon office says: "Where there is sufficient advantage for us to call for a captive line, we will." That advantage, naturally, will be obtained most easily from companies that have had experience working with strict assembly techniques and that have had access to know-how derived from radiation-hardening research sponsored on captive lines.

Circle 260 on reader service card →



**Recording star
on the
way up.**

417—the lightweight recorder that fits under the seat

If you have to fly to where the data is, take the 417: the one recorder you carry aboard and keep with you, right under the seat. No time lost in packing, shipping, and unpacking. No chance of damage from mishandling.

Only 6" x 14" x 15", the rugged 417 weighs just 28 pounds—50 pounds less than any comparable recorder. Works in any position, under roughest vibration conditions, for dependable data gathering in plants, labs, on and under the seas, or out in the wilds.

Maintenance-free mechanism has exclusive low-mass differential capstan drive for precision operation.



LOCKHEED

Lockheed Electronics Company. A Division of Lockheed Aircraft Corporation

Phaselock servo for precise speed control, with accuracy matching large rack machines. Records on 7 channels, IRIG compatible. Runs on 110/220v AC/DC or internal battery. Power consumption as low as 10w. Frequency response: 100 kc direct, 10 kc FM.

Priced as low as \$7,000.

Send for our catalog containing full details on the 417, one of a family of precision data recorders for land, ocean, air and space applications. Write: Boyd McKnight, Dept. ED-7-A, Lockheed Electronics Company, Edison, New Jersey 08817.

Have questions on data recording? Call us at (201) 757-1600.

Report from

**BELL
LABORATORIES**

Microbridges for electrons

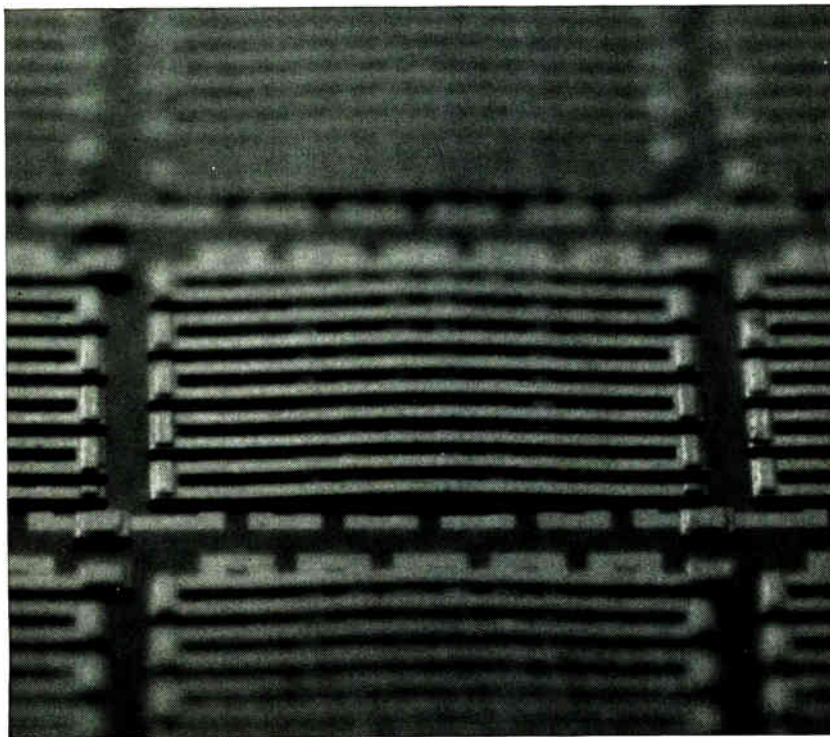

Part of an experimental test pattern. This pattern, with 13,700 microbridge crossovers on a silicon substrate, has been fabricated without a short circuit. Each of the crossovers is less than 1/16 in. long. The combination of air and solid insulation can withstand 200 volts.

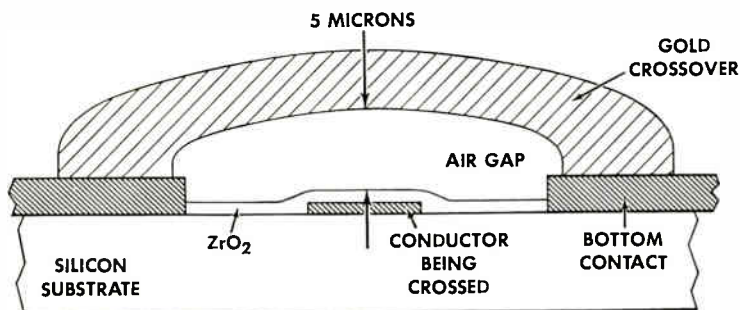

Cutaway view showing formation of the new microstructure: First, layers of titanium and platinum are deposited over the substrate to form both the conductors to be crossed and the bottom contacts. A layer of zirconium is then put down. Next copper, a spacer for formation of the crossover, is evaporated overall. Windows are etched through the copper so the crossover can reach the lower-level contact. The crossover is then applied in position by gold-plating the copper spacer; the spacer is then etched away. The zirconium layer is oxidized to act as protective insulation. Any pinholes present do not become short circuits.

As integrated circuits become more complex, designers are faced with something akin to the old puzzle: "without crossing any lines or lifting your pencil from the paper, connect so-and-so-many points." In a puzzle, it's just for fun, but with circuits it has been a design requirement.

Until now, most conductors have been crossed in virtually the same plane, separated only by extremely thin insulators. Such crossovers are undesirable because of the danger of leakage through pinhole imperfections in the insulator. As integration technology evolves, hundreds of crossovers may be needed on a single substrate. A short in any one means rejection of the entire substrate. For such integrated circuits to compete economically, the integrity and manufacturing yield of crossovers must approach perfection.

Obviously, the designer would like to "lift his pencil" . . . make the crossing conductor rise above the one beneath it.

Recently, Martin P. Lepselter of Bell Telephone Laboratories has done just that. He has invented a process for making "microbridges" . . . integrated-circuit leads which cross others through the air, without touching (photo, left).

This new technique solves the insulation problem; because of the air gap, pinholes in the insulator do not cause leakage. It also reduces capacitance between the conductors. Finally, by separating the various materials, it eliminates stresses due to unequal thermal expansion.

The key to the technique (drawing, left) is a layer of a material like copper that can be selectively etched away, leaving an air gap between the conductors. Thus the combination of air gap and insulating layer provides a degree of insulation protection not previously available. Insulated circuits with microbridge crossovers will be used in a wide variety of communications equipment in the Bell System.



Bell Telephone Laboratories
Research and Development Unit of the Bell System

Recruiters flock to Negro colleges

Black schools produce relatively few EE's, and many problems remain, but tokenism seems to be on the way out as grads are hired on merit

By Robert Skole

Washington bureau manager

Five years ago, recruiters seeking the engineering graduates of predominantly Negro universities were about as numerous as black faces at an IEEE meeting. Today, the status quo still prevails at technical get-togethers, but the campuses were overrun this spring.

The rush to hire black engineering graduates is, in most cases, prompted by Federal equal-employment regulations covering Government contracting.

But some companies began to hire blacks years ago and gave them real opportunities for advancement. Many others waited and made only token efforts. And even today, some firms only go through the motions of recruiting black engineers or take on a few as showpieces.

Because so many recruiters are besieging the Negro universities, competing hard for engineering graduates, the placement directors at these institutions are saying: "We'll be keeping out those companies that haven't been sincere and working harder with those that have given our graduates the best opportunities."

Bench marks. The situation is still fluid, not only because of the dynamics of the civil-rights movement but also as a result of ambivalent attitudes on the part of both blacks and whites. However, certain patterns are clearly discernible:

- Smaller companies without extensive recruiting programs face tough going even when they sincerely want Negro engineers.

- Although Negro universities are turning out relatively few electrical engineers—about 100 from the

dozen schools offering such degrees—there will be a big increase in future years, making these schools far more attractive from a quantity standpoint. Meanwhile, moves are being made to upgrade curriculum quality.

- Some recruiters and personnel managers are so far out of touch with Negro students that they will find it tough to catch up with efforts made by more understanding officials.

Roundup

Electronics firms are increasing their efforts to recruit at Negro universities at a rate far greater than most other industries. "I wish

we had five times as many engineers graduating this year," says W.I. Morris, placement director of A&T College, Greensboro, N.C. "In the last six years we've certainly had a 1,000% improvement in the number of recruiters coming here."

A&T had a dozen EE grads in a senior class of 425 this year; overall, only 60 were science majors. "For so many years, opportunities in engineering were not open to us," says Morris. "But prospects are brighter today. Each of our engineering graduates had three to six job offers."

The dramatic growth in the

New start

Most engineering graduates of Negro universities head for the Northeast or West Coast, but one in Howard University's class of '68 preferred going south—to his hometown, Atlanta.

Thomas Jones had five job offers from top electronics and aerospace firms. "But I accepted an offer from Lockheed-Georgia," he says. "I've worked two summers as a draftsman there. I know the company and I think Atlanta is the only place to go. It's fast-growing and has an affluent Negro community. Most of the attitudes are pretty liberal."

Jones says he tried to encourage a classmate from Virginia to take a job in Atlanta. "He told me, 'I'm from Virginia and Atlanta's too far south,'" Jones says. "I couldn't convince him it might be better to live there than in some northern cities."

More than money. Jones is frank in discussing the problems a Negro engineer faces. "It's always a big problem to figure out if a company wants you because you're you or because you're black," he says. "But if you watch to see who the companies are after on campus, you can tell. I often wonder what it would be like to get a job if I weren't a Negro. But this makes you determined to do the job better."

Jones says that he'll be working in aircraft stress analysis to start with. Eventually, he wants to work his way into control systems and computer controls. Jones notes that a lot of his classmates were attracted by the "glamour" of IBM and its work with computers, and he says they know IBM is sincere.

As for money, Jones was offered from \$730 to \$800 a month—about average for new EE's. Jones says, however that job opportunity and housing are even more vital to black graduates than salary.

E miniature
**DC-18 GHz motorized
 programmable
 stepattenuators
 0-129 dB**



New μ Miniature Motorized Programmable Stepattenuators come with values as high as 129 dB in 1 and 10 dB steps. These 50 ohm μ series 96, 97 and 98 Stepattenuators come in a choice of 8 standard RF connector options (coaxial or waveguide); 5 standard frequency ranges; 17 standard insertion loss ranges; and single, double or triple drum assemblies internally connected in series with low reflection adapters to minimize mismatch errors.

They feature \square switching life exceeding 1,000,000 steps \square excellent repeatability \square high stability under wide range of environmental conditions \square low leakage \square low VSWR \square and low minimum insertion loss. In addition, they are motorized and easily programmable.

Switching time is typically 2 seconds. Repeatability exceeds ± 0.01 dB/drum up to 10 GHz. Maximum VSWR for all μ series 96 units is held to less than 1.50 and to 18 GHz and to below 1.15 for lower frequencies.

The ease with which these models are programmable makes them especially useful in systems employing automatically controlled levels. These stepattenuators can be switched more than one million times without deterioration and without in-between maintenance.

Designers and
 Manufacturers of Precision
 Microwave Equipment

**WEINSCHEL
 ENGINEERING**

Gaithersburg, Md. 20760
 Tel: (301) 948-3434
 TWX: 710-828-9705

number of recruiters seeking black graduates is apparent in data from Southern University, Baton Rouge, La. In 1960, 15 recruiters went to the school; 12 were after teachers and three were from Federal agencies. This year, there were 556 recruiters on campus only 55 of whom were seeking teachers.

"About 50% of the recruiters were looking for engineers, and a large part of these were after EE's," says James McKay, placement director for Southern U. The school graduated 24 EE's this year, and each averaged eight job offers.

Bigger rosters. This is now more or less typical of Negro universities. Also typical is an increase in engineering enrollment. In 1967, Southern's engineering department—which graduated 40 this year—had a total enrollment of 450; the 1968 figure was 570. Thus, in a few years, the number of graduates will double.

Because of the intense competition for the relatively few graduates, many companies don't feel the effort is worth it. And some companies will say—privately, of course—that they don't think the scholastic standards at Negro institutions are high enough for them to go to the trouble of recruiting there.

In general, the approach to recruiting at Negro universities is the same as at white schools. However, few firms have tried to tailor their programs. For example, when they were new to this whole thing, some companies thought it would be a good idea to send Negro recruiters to Negro schools. This didn't work well, especially when the recruiter was obviously not a professional. Students resented the companies' patronizing attitudes.

However, some firms today send an integrated team to Negro universities—a white professional personnel man accompanied by a Negro engineer or scientist. The white recruiter will talk to the prospect about the job and the company, and then leave the Negro alone with the student "to tell it like it is." Most Negro college placement directors have serious doubts about the effectiveness of this approach.

"One of the biggest problems facing companies that want to hire our students," says Southern U's

McKay, "is the quality of the recruiter—they often can't identify with the students."

Placement directors agree that students can easily identify an "insincere" recruiter, and they're getting ready to lower the boom. "It's going to be very necessary to screen the companies and recruiters in the future," says McKay. "We know the recruiters who come just for show."

Shortcomings

A major problem facing most Negro universities is the lack of facilities for recruiters and adequate job-counseling and placement services. And even though it is understandable that no Negro college administration a few years ago would have believed there would be an urgent need for such facilities, there are still recruiters who can't figure it out. A personnel director with a large West Coast aerospace firm, who insists on remaining anonymous, grumbles: "Interviewing rooms are about as big as my desk and the furniture must have been left over from the Civil War."

Because of a lack of facilities, most Negro schools have good reason to screen companies and concentrate only on those with a history of "sincerity." Officials say Negro universities will no longer be "used" by companies that simply go through the motions. "I'm convinced some companies are not sincere," says Walter G. Hawkins, placement director at Howard University, Washington, D.C. "This is particularly true of insurance and banking. But there are some in engineering, and they can least afford the luxury of prejudice."

Paeans. IBM receives high praise on Negro campuses. Hawkins says that although he and his staff try to be impartial, the track record of IBM and some other companies is so good that they naturally do all they can to help these firms. IBM, for example, interviewed more Howard students than any other company this year: 60 graduating seniors. It made 15 job offers, and eight students accepted. On the other hand, some lesser-known companies that don't have a reputation on Negro college campuses have trouble even getting students to interview.

For example, Ampex got only two applicants from Howard this year, the first time it recruited at the school. "We were terribly disappointed," says Arthur O. Stoeffen, the company's recruiting chief. Figuring the averages, however, Ampex did very well. Howard had 100 engineering graduates this year, 30 of them EE's. But 400 companies were after engineering talent at the school.

Some companies know very

little about desires of Negro graduates. While most engineering graduates want to work in the Northeast or on the West Coast, where housing is generally less of a problem, Stoeffen, for one, says he feels that the students at Howard didn't want to move to the coast. And Richard G. Henne-muth, vice president for industrial relations at the Raytheon Co., Lexington, Mass., says: "We have considered recruiting at Tuskegee

Ben Berry's way

One Negro electronics engineer who has "made it" as a respected professional in his specialty says the goal of others like him is entry into corporate policy-making positions in the nation's aerospace industry.

Ben Berry, a graduate of the University of Southern California who came from the ghettos of Los Angeles to become a department staff engineer with the Electronic Systems division of TRW Systems in Redondo Beach, Calif., says Negroes are now being promoted to a certain point—but no higher. "When I first came to work in the industry a decade ago people used to stop and stare at us," Berry says. "Now we're accepted, but not as completely as we might like. Initially, Negro engineers were very close to each other—it was like a club—because the whites were ostracizing us. We banded together almost for protection."

Negroes are now readily accepted at nearly all levels within the industry. "But at upper-echelon positions, the competition for advancement is stiff, and it's difficult for Negroes to move into top management," Berry says. "Certainly it's harder for a black scientist or engineer to move beyond a certain level," he continues. "You can count the number of black managers in Los Angeles on your fingers. I know them all, and there aren't many."

Hope. But Berry is far from being disillusioned about the fate of talented Negroes in industry. "Things have definitely moved ahead for the black professional," he says. "The situation is really improved in respect to the smaller electronic outfits. They used to be the ones who positively wouldn't hire Negro engineers. It got to a point that blacks wouldn't even bother responding to their ads. Because of contractual requirements set up by the Government, these firms are dying to get some blacks on the pay-roll, but the black man isn't interested. These companies have developed bad reputations among Negro professionals and it's going to take a lot to prove they've had a change of heart."

Limits. At present, Berry says he and other Negroes don't feel they are completely accepted by some of their white colleagues. "For example, we find that at meetings what we say is often not regarded with much concern," he notes. "We'd like to think it's a case of our not being forceful enough in presenting our views, but deep down we know differently."

"The Negro professional walks in two different worlds. At work it's the white man's world. At home, it's the world of the ghetto," Berry says.

The TRW engineer has formed an organization called Society of Scientists and Engineers of America. Composed mainly of black professionals, it works with ghetto youngsters to show them there is a way out of the slums. "This summer we're conducting a series of workshops and lectures at Negro high schools in the Los Angeles area to try and get these kids to realize the opportunities open to them," Berry says. "We tell them the same cross-section of intelligence exists in the ghetto as in other areas of the city. But high school is really too late. For kids to be motivated, you have to reach them early, before they become so disgusted with society they feel there's nothing in it for them."

—Burton Bell
Los Angeles regional editor

General Electric Fused Quartz Meets The Electronics Industry's Challenge With:

- HIGH TEMPERATURE STRENGTH
- PURITY
- THERMAL SHOCK RESISTANCE

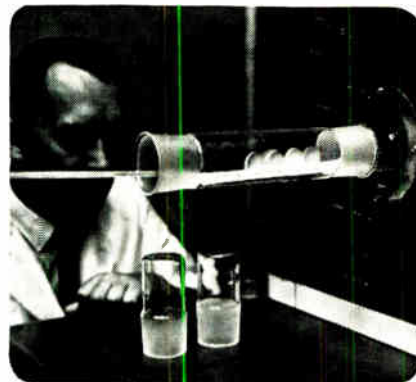

Here's an example of General Electric's fused quartz at work for the Computer Control Division of Honeywell Inc., Framingham, Mass. This diffusion tube manufactured from GE Type 204 quartz tubing contains a "carrier sled" loaded with photographically processed silicon discs, allowing them to be chemically treated inside a high temperature (1200°C) furnace. Ultimately, the discs become monolithic integrated circuits for computers, with each pinhead-size circuit the equivalent of 20 to 60 discrete components. Why does Honeywell use GE fused quartz tubing? Because of its noncontaminating purity, high temperature strength and excellent thermal shock resistance. And as Honeywell continues to benefit from the exceptional properties of GE quartz, researchers everywhere are discovering more and more excitingly new and purposeful applications for this extraordinary quartz. Are you?

WORLDWIDE SERVICE. For sales and application assistance, contact your nearest regional office:

CALIFORNIA, Los Angeles	213 723-2541
ILLINOIS, Chicago	312 282-7905
MASSACHUSETTS, Boston	617 332-6200
NEW JERSEY, Newark	201 824-5200
OHIO, Cleveland	216 266-4001
CANADA, Toronto	416 537-4481

Write for illustrated technical literature today.

LAMP GLASS DEPARTMENT

GENERAL ELECTRIC

24400 Highland Road
Richmond Heights, Ohio 44143

Manufacturers of Lucalox® Ceramic
Electronic Glassware—Fused Quartz Products

IC SEALING PROBLEMS SOLVED

WITH WILLIAMS' IMPROVED ALLOYS FOR MICROELECTRONIC DESIGN.

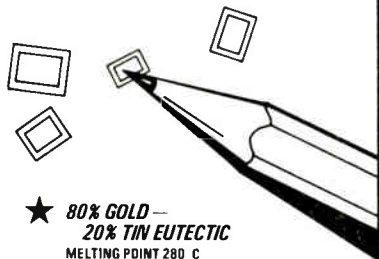

★ **80% GOLD — 20% TIN EUTECTIC**
MELTING POINT 280 C

★ **88% GOLD — 12% GERMANIUM EUTECTIC**
MELTING POINT 356 C

★ **SOLDER PREFORMS FOR SEALING INTEGRATED CIRCUIT PACKAGES**

★ **TOOLING AVAILABLE ON MOST STANDARD SIZES**
4 to 6 Weeks Delivery on New Tooling

PARTIAL LIST OF AVAILABLE ALLOYS & SOLDER PREFORMS

88% Gold 12% Germanium (Eutectic Alloy)
Strip and solder preforms in all sizes
80% Gold 20% Tin (Eutectic Alloy)
Strip, wire and solder preforms in all sizes
Gold with .1 to 1.2% Antimony
Wire, strip and solder preforms all sizes
Gold — .05% Min. Phosphorous
Wire, strip and solder preforms all sizes
95% Gold 5% Nickel
Wire, strip and solder preforms all sizes
Gold and up to .5% Arsenic
Strip and solder preforms all sizes
Silver with .1 to 1.2% Antimony
Wire, strip and solder preforms all sizes
Silver — .1% Min. Phosphorous
Wire, strip and solder preforms all sizes
95% Silver 5% Nickel
Wire, strip and solder preforms all sizes
Silver and up to .5% Arsenic
Strip and solder preforms all sizes
Special alloys produced on request at minimum charge.
Precious Metals in 99.9% Pure, 99.99% Pure, and 99.999% Pure.

Modern, up-to-date refining of precious metals and complete spectrographic facilities available

HIGH PURITY METALS USED ON ALL ALLOYS

WRITE FOR COMPLETE PRECIOUS METALS CATALOG AND SPECIFICATION SHEETS. PHONE 716-834-7204

OVER 50 YEARS OF PRECIOUS METALS EXPERIENCE

**WILLIAMS
PRECIOUS
METALS**



2978 MAIN ST. BUFFALO, NEW YORK 14214
Division of Williams Gold Refining Co., Inc.

Institute in Alabama, but our experience has been that neither blacks nor whites like to come this far north. Generally, we find about 50% of our new engineers in the New England area, though we recruit throughout the country.”

Pro and con

Companies are taking different approaches in working with Negro universities and students. Some, like Hewlett-Packard, donate laboratory equipment to colleges. Others with years of experience working with Negro educators and placement directors—for example, IBM—arrange luncheon meetings to get faculties to pass the word that the company is seriously looking for a broad range of graduates.

But some companies appear to have taken a hard-nosed attitude and researched themselves right out of this market. TRW Systems, Redondo Beach, Calif., formed a team of scientists, engineers, and personnel specialists to visit Negro universities to get a “feel” for the schools. “We intended to add them to our campus recruiting schedule,” explains James Lacy of the placement staff. “But we rejected the idea because their graduates were not, in our view, equipped to handle the technical tasks required of them here.” Many companies say the same thing, but don’t want to be identified, even though most Negro administrators agree that their schools are indeed deficient in curriculum and equipment.

Disadvantaged. The Negro graduate of a predominantly white school is as capable as a white graduate, stresses Robert Thomson, director of manpower planning at the Bendix Corp. “But at the predominantly Negro school,” he says, “the student is at more of a disadvantage. Here the engineering program may have been in existence only five years. MIT probably wasn’t all that good after only five years. Where the engineering curriculum is very new it takes longer to get top-quality grads. In the past three years, however, we have seen a narrowing of the gap.”

Some companies have set up programs to compensate for educational shortcomings of graduates of Negro schools. The Western Development Laboratories division of the Philco-Ford Corp., for example, will sometimes bring a graduate of

a Negro university who doesn’t measure up to the average grad and give him supplemental job training and support to continue his education.

Other companies, for example the one whose recruiter complained about the Civil War furniture, flatly write off the scholastic competence of most Negro universities. “The graduates can read and write and that’s about all,” says the company’s top employment officer. “Spending money to recruit Negro engineering graduates from predominantly Negro colleges in the south is like throwing money down a rat hole.”

Old story. This kind of attitude is familiar to Negro educators and students. “I have a feeling that company representatives are often laboring under a stereotype,” says Fred Scott, placement director of Hampton Institute, Hampton, Va.

Most educators, administrators, and students realize that many companies will hire a few blacks for show. “But I don’t think the electronics industry is as guilty in this regard as others,” says Scott.

Uneasy dialogue. One of the major problems remains communications between the recruiters and prospects. Most recruiters say that students at Negro universities aren’t as well prepared for interviews as their white counterparts. Officials and faculty members at Negro schools respond that this comes of companies’ precipitate rush to hire blacks; the move is so new that the schools haven’t had a chance to organize for it.

Phillip M. Oliver, industrial relations director for Philco-Ford’s Western Development Lab, says: “At any college, where we find a black engineer, we hire him. I regularly visit a half-dozen Negro colleges. Their real problem is getting men to appear for an interview and to condition them for competition in the white world. They want this competition—but they aren’t trained to accept it.”

“They are almost like foreigners in their own country in that respect. Take, say, an engineer from Indonesia; he might want very much to win a job and get ahead, but he wouldn’t know exactly how to go about it. Some of the Negro graduates are in the same position, like fish out of water.”

HERE'S HOW...

THE ELECTRONIC INDUSTRY IS USING THESE FAMOUS ULANO FILMS IN ULTRAMINIATURE MASK TECHNOLOGY AND COMPLEX PRINTED CIRCUITRY

Cut a piece of the desired film large enough to cover area to be masked. Tape it down firmly at the top with dull-side up.

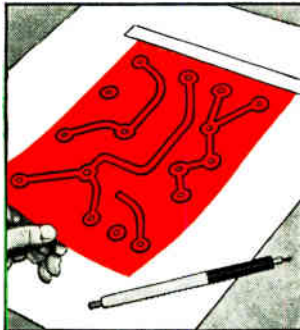

With sharp blade, outline the areas to be masked. *Do not cut through the backing sheet.* The Ulano Swivel Knife does the job quickly, easily.

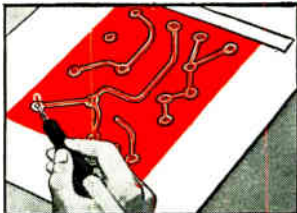

Using the tip of the blade, lift up a corner of the film thus separating it from the backing sheet.

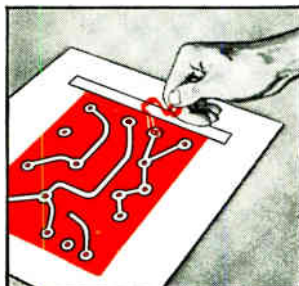

Now carefully peel off the film as outlined leaving a completed mask, positive or negative, that corresponds exactly to the desired pattern.

UlanoTM

RUBYLITHTM AMBERLITHTM

HAND CUT MASKING FILMS FOR THE GRAPHIC ARTS

ULANO RUBYLITH... a revolutionary knife cut red film is laminated to a stable transparent plastic backing sheet. The red film is "light safe" so that when contacted to a sensitized emulsion and exposed to a suitable light source, light passes through the cut-out portions only... not through the red film. ■ The polyester backing is absolutely stable... insures perfect register. ■ Special effects such as crayon tones, paste ups, benday sheets, and opaquing are easily combined with versatile ULANO RUBYLITH.

ULANO AMBERLITH... a companion to Rubyolith serves as a color separation medium used as the master on camera copy board to secure negatives or positives.

*A wide variety of Ulano films—
in rolls and sheets—is readily available*

Designed FOR YOUR PARTICULAR NEEDS

Ulano offers the most versatile line of hand-cut masking films, including:

.0075—RUBYLITH 75 DR* .005—RUBYLITH 5 DR†

.005—AMBERLITH 5 DA†

Where exact register assures a critical importance, you will find these new, thick, polyester based films the positive answer.

* Available in sheets only, cut to your specifications
† Available in rolls and sheets



WRITE TODAY
on your letterhead for free
special sample kit 1748

"Ulano"—"Rubyolith"—"Amberlith" are registered trade marks of the Ulano Companies.

ulano

610 DEAN STREET, BROOKLYN, N.Y. 11238

In Europe: ULANO A.G., Untere, Heslibachstrasse No. 22, Kusnacht, Zurich, Switzerland

Do you want to go LSI now?

If you really want LSI now, grab the next plane to Mountain View. (It lands in San Francisco.) It's the quickest, least expensive way to get LSI into your system.

Plan to bring along your blueprints. And be ready to answer a lot of questions. We'll need to know what you have in mind for sub-systems, functions and specs. And, don't be surprised when we ask "why" a couple of times. It's all part of Fairchild's systems approach to complex circuitry.

We'll take your requirements and match them against our family of fundamental building blocks. We've got LSIs (and MSIs) that work in any digital logic system. The most advanced circuitry on the market. Offspring of computer-aided design and double-layer metal technology. And, they're all so versatile, we can probably give you a counter that has a dozen other applications in your system.

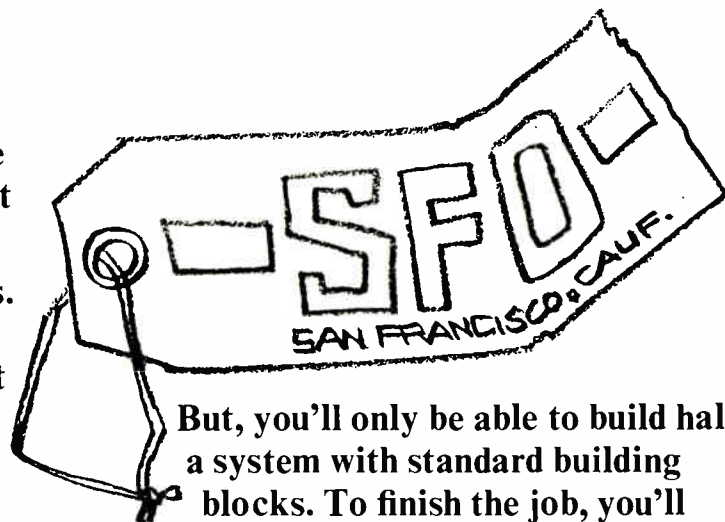

But, you'll only be able to build half a system with standard building blocks. To finish the job, you'll need interface devices to tie the whole thing together. And, here's where Fairchild can really save you time and money. We don't have to custom design each LSI interface circuit. We use Micromatrix™—a unique cellular array that's completed when we add your specific interconnection pattern. Your specs customize the entire array for your system.

Of course, there's a lot more to the story. But, you ought to hear it in person. Just call your Fairchild salesman. He knows the flight schedule to San Francisco.

Or do you want to think about it?

We've got an LSI design kit. It's based on our new 4500 Bipolar Micromatrix Array — the first device in a highly versatile LSI family. The 4500 is an eight-cell array that can be customized for virtually any function. All it needs is your interconnection pattern. You can determine the pattern by designing your own Micromatrix array with our kit. You can buy a kit from your Fairchild distributor for about \$100. And, in a couple of months, we'll see you in Mountain View.

FAIRCHILD
SEMICONDUCTOR

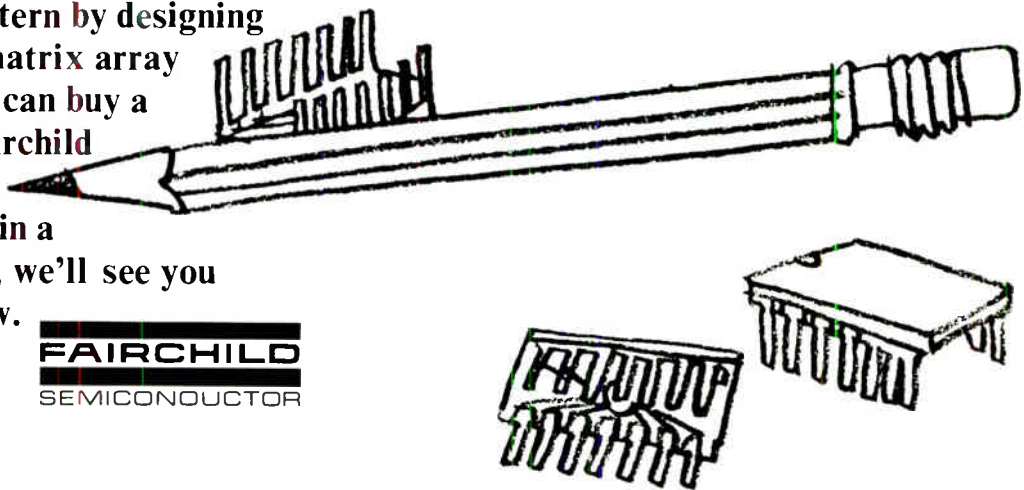

**Our story starts
with a very
superior
polyester film.**

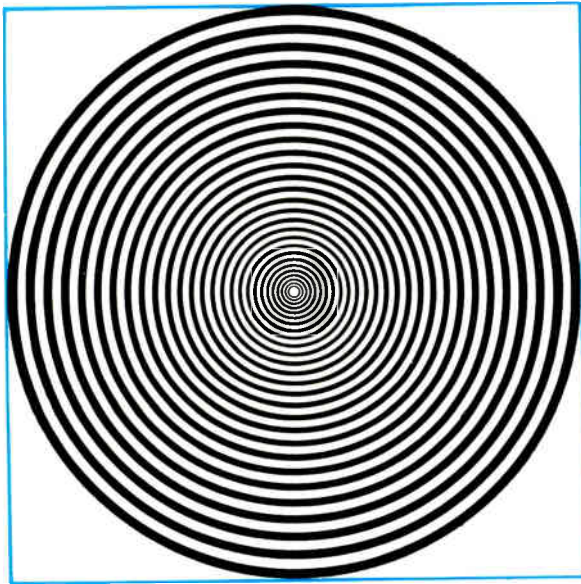

**To which we
add exceptional
dimensional
stability.**

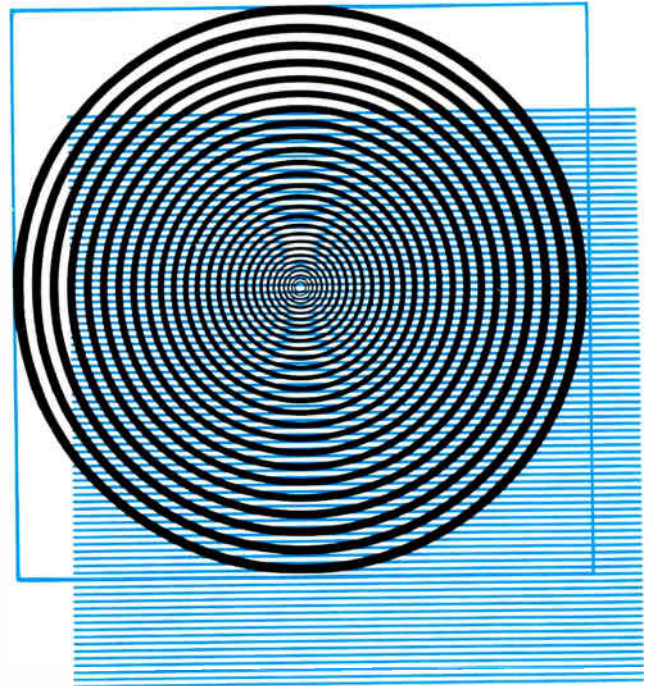

The best dimensional stability of *any* polyester film. An independent testing lab, DeBell & Richardson, Inc., tested calibrated lengths of Celanar and other polyester films at temperatures from 73F to 120F for over 24 hours. When measured, other films showed up to 77% greater thermal expansion than Celanar film.

And greater strength.

Celanar is the strongest balanced biaxially oriented plastic film commercially available.

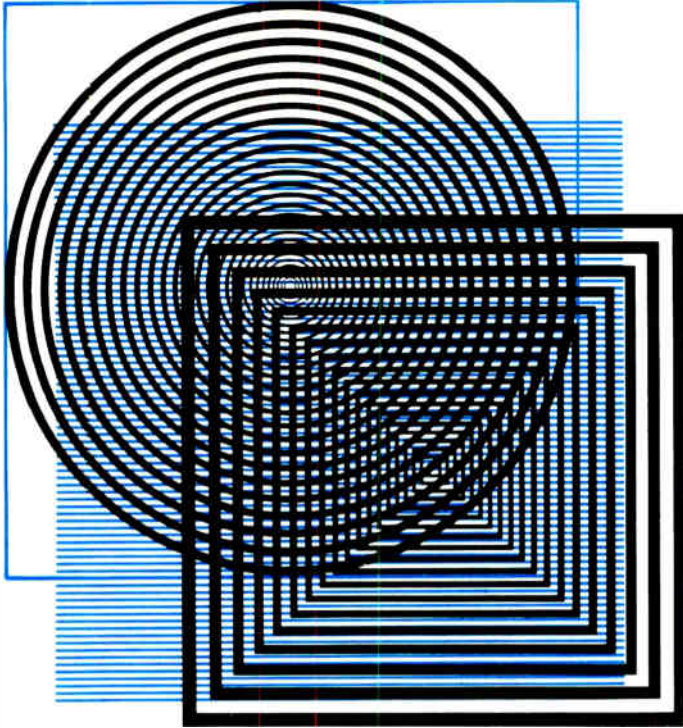

And insulation resistance.

An outstanding property of Celanar film is its high insulation resistance over a wide range of temperatures. Celanar has superior electrical properties, including excellent dielectric strength, dielectric constant and dissipation factor. Good reasons why Celanar is widely used as an insulating material in electrical insulation applications.

To bring you Celanar Film with a combination of properties unsurpassed for electrical uses.

Celanar polyester film offers a balance of electrical, mechanical, thermal and chemical properties that make it your best choice for applications from flexible circuits to wire-wrap. Want proof? Just mail the coupon.

Celanese Plastics Company
Dept. 133-G, P. O. Box 629
Linden, N. J. 07036

Yes, I want all the facts about Celanar film for electrical applications. And send me a FREE set of gratings printed on Celanar. (Laying one on top of the other produces Moiré patterns that confound the eye.)

Name _____ Title _____

Company _____

Address _____

City _____ State _____ Zip _____



CELANESE
PLASTICS COMPANY

Celanese®
Celanar®

Celanese Plastics Company is a division of Celanese Corporation.

POLYURETHANE-BUTYRAL

SB GENDURE

MIL-W-583C—Type E

When used as magnet wire insulation, GENDURE SB exhibits excellent characteristics of dielectric overcoat layers, and is particularly characteristic in manufacturing the coil wire. It can be processed further by the manufacturer to meet further requirements. The following instructions should be followed in processing magnet wire insulation. The processing should be done in accordance with the instructions in MIL-W-583C.

POLYURETHANE-POLYAMIDE CLASS B, 130°C GENDURE N

NEMA—MW 100B/1967; MW 28-C; MIL-W-583C—Type E

Polyurethane-Nylon magnet wire insulation combines the excellent characteristics of GENDURE, including solderability, but has improved windability because of the nylon overcoat. Nylon does not reduce the solderability, but significantly increases the solvent resistance and thermal rating of the insulation. It also permits the use of GENDURE N magnet wire in applications subjected to severe winding or mechanical requirements.

Type	Abbreviation	Size Range
Single Built	SJN	14-44 AWG
Heavy Built	HUN	10-44 AWG

EPOXY GENEX

NEMA—MW 28-C; MIL-W-583C

Epoxy magnet wire insulation exhibits excellent electrical resistance to moisture. The insulation of GENEX exhibits high mechanical strength. GENEX is used in transformer and motor windings. Most types of GENEX are compatible with copper wire insulation. GENEX is compatible with other materials.

Type
Single Built
Heavy Built
Square Root

POLYESTER CLASS F GENTHERM

NEMA—MW 28-C; MIL-W-583C—Type E

Polyester magnet wire insulation is used in applications where high insulation resistance is required.

If you need magnet wire to meet almost any application requirement, here's the first place to look.

It's the GCC Guide to Magnet Wire.

It indicates which insulation to use if you need magnet wire to withstand heat or abrasion; with special winding characteristics, electrical properties, high moisture resistance, or immunity to solvents, oils, or freon refrigerants.

This Guide also tells you that you can get them from GCC. We'll be happy to send you a copy. Write to General Cable Corporation, Section 700-04, 730 Third Avenue, New York, New York 10017. For detailed information on specific applications, call your local GCC salesman.

GCC
GENERAL CABLE CORPORATION



Is it possible to get a really good computer for less than \$10K? How about \$9,950 and some odd change?

That's what the new Hewlett-Packard 2114A will be pegged at. But it'll heave to just like its big brothers. Throwing around big 16-bit words. Storing 4000 (or 8000) of them at a time in memory. Fetching them out of memory in two microseconds. It'll tie in I/O devices with standard plug-ins and use the same set of programming languages — FORTRAN, ALGOL and Conversational BASIC. It may be the littlest computer in the HP family... but even at that it more than holds its own against its big brothers.



That's right. The HP 2114A offers the most desirable price/performance ratio of any computer on the market. And it won't take up much room, either, not even on your desk. One compact package 12¼" tall houses both processor and power supply.

Yet the economy model is fully compatible with all the 2115/2116 software and I/O interfaces. The main frame accepts either 4K or 8K memory, has eight I/O plug-in slots and operates within a wide temperature range. Low-cost options include parity error check and power-fail protection.

If you think this powerful little computer is right for you, get more information from your local HP field engineer. Or write Hewlett-Packard, Palo Alto, Calif. 94304; Europe: 54 Route des Acacias, Geneva.

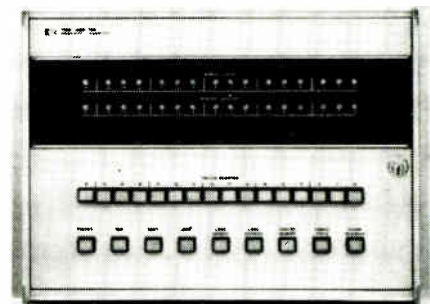

HEWLETT  PACKARD

DIGITAL COMPUTERS

New Products

Integrated electronics

TTL makers switch their sales pitch

Texas Instruments, Sylvania, and their followers contend on pin configurations and encapsulation techniques, but every semiconductor house emphasizes complexity

By Eric Aiken

Probing the news editor

"Transistor-transistor logic has reached a real flowering stage," says Walt Weyler, marketing manager for TTL at Texas Instruments. "What's more, its success is based on economic as well as technical considerations." Toward the end of last month, TI put through price cuts of 40% on low-power TTL lines in plastic packages. At the same time, prices of comparable devices in flatpacks were reduced by 25%.

The company was not simply indulging itself in a self-fulfilling prophecy. Friends and foes in the semiconductor field share Weyler's optimism so a marketing struggle seems inevitable.

Twosome. At this point, the principals in the contest are Sylvania with its two lines of SUHL (for Sylvania Universal High-Level Logic) and TI with its 54/74 series of circuits. Lesser lights are aligning themselves with one or both of the top two as second sources, while concerns like Motorola, Signetics, and Fairchild Semiconductor push proprietary entries.

The already large dollar sales of TTL are expanding at a heady pace. For example, first-quarter volume was around \$17 million. "With a flat projection for the rest of the year, this would suggest an annual volume of around \$70 million," says TI's Weyler. "But we're

not dealing with a flat pattern. Growth is going to be strong and dramatic from here on out."

Quickstep

Joseph Nola, product planning specialist at Sylvania's Semiconductor division, agrees: "We were predicting that TTL would overtake diode-transistor logic some time in 1970 or 1971. But it now appears the crossover will occur next year."

"From June to December in 1967, TTL grew from 15% to 26% of the market. And who was shipping SUHL then?" asks Bill Berg, marketing manager at Signetics, in a rhetorical reference to Sylvania's delivery problems. "What gives SUHL more thrust this year is that Motorola has it."

Flushed with success, integrated-circuit makers have even begun to change their sales pitch. Where once they talked lightning-fast switching speeds, noise immunity, high fanout, and low power requirements, marketing men now extol the widespread availability and complexity of their devices—perhaps because they can now produce acceptable assemblies in commercial quantities.

Gaining experience

TTL circuits require small geometries, thin lines, and shallow dif-

fusions—all of which can lead to production woes. With experience, however, IC makers have overcome most, if not all, of their difficulties. "Our yields are as much as four times greater than a year ago," reports Sylvania's Nola. "We're climbing right up the learning curve with output."

At Raytheon Semiconductor, which has invested \$500,000 in a separate TTL facility with a rated



Big ante. Raytheon regards TTL outlook rosy enough to have invested \$500,000 in a facility to second-source SUHL.

■ With a little square hole at one end and a round one at the other, our HW Series Wire-Wrap* connectors are positioned quickly and perfectly. Every time. The result is a higher rate of Wire-Wrap production. Especially with our new AccurFrame Packaging.

● But the hole is only a part. Winchester Wire-Wrap connectors have a configuration designed for automatic equipment, high strip force retention, bifurcated spring contacts for superior interfacing. They're available in sizes ranging from 22 to 50 contact positions.

Standard contact spacing in two sizes: .125 center to center with .250 between rows; and .100 center to center with .200 between rows.

Contacts are easily removed. Retained by a 90° twist. Molding is diallyl phthalate SDG-F.

Contacts plated to MIL-G-45204 Type II.

■ HW connectors are the heart of AccurFrame, a simple and reliable packaging technique that capitalizes on Winchester's long experience in precision molded connectors. No new fabrication methods are required. Frame positioning is simplified with no tolerance buildup. All at a low average cost per contact.

That, pardon the pun, is the hole thing.

Except that HW connectors are available from your distributor. Or Winchester Electronics, Main St. & Hillside Avenue, Oakville, Connecticut 06779.

WINCHESTER ELECTRONICS 
LITTON INDUSTRIES

the hole thing.

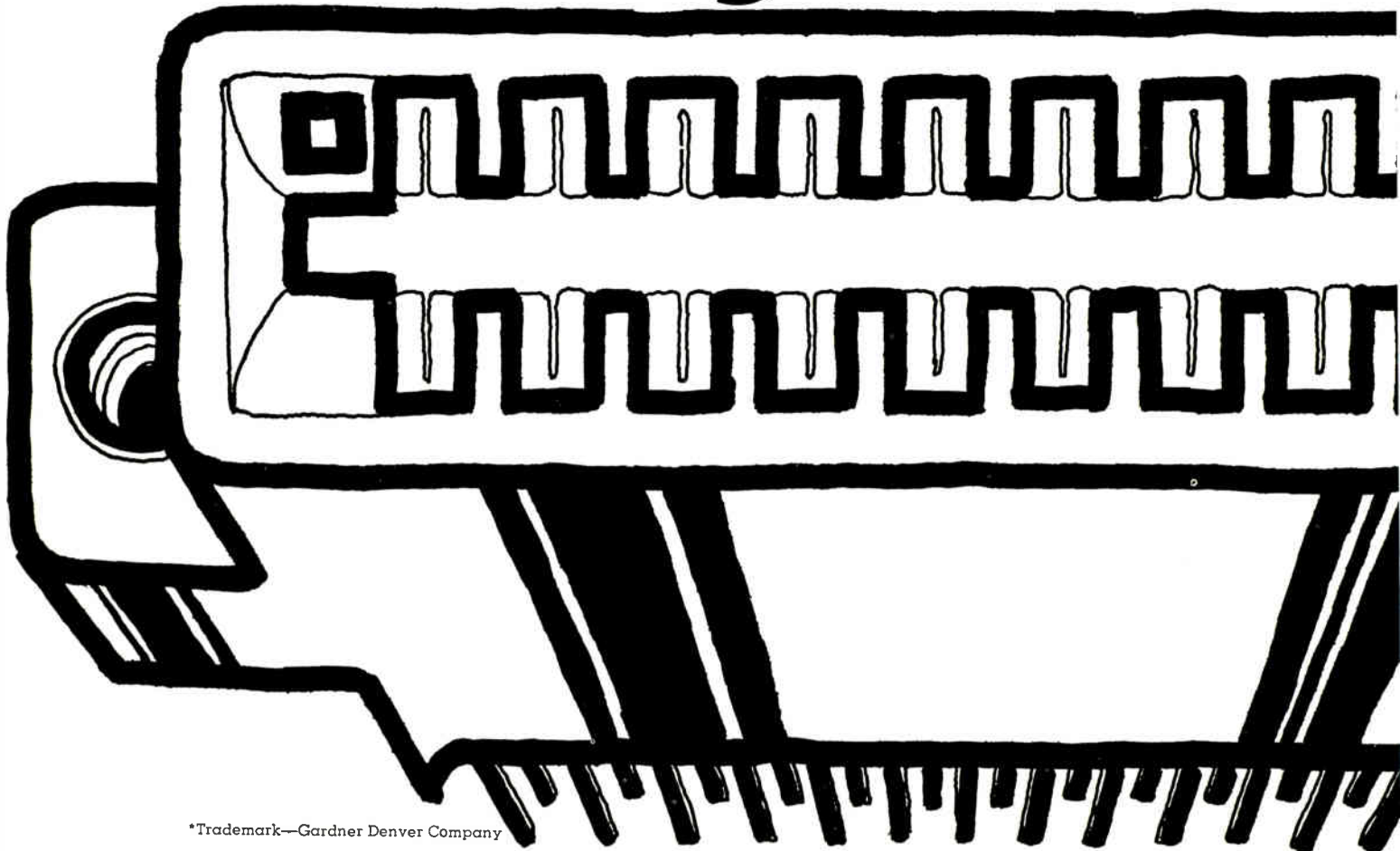

*Trademark—Gardner Denver Company

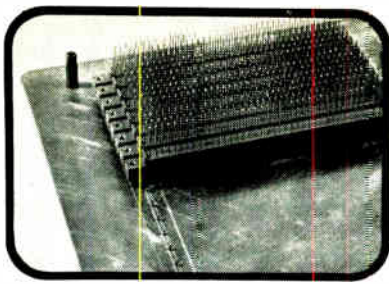

Alignment holes in HW Series connectors are polarized for fast, sure alignment.

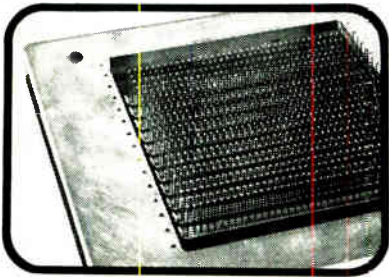

With the connectors in position, a wiring frame is added.

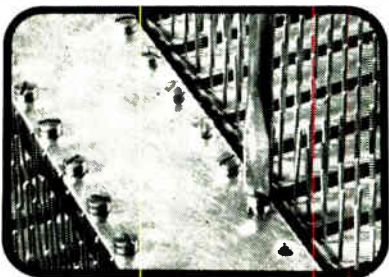

Connectors are attached with machine screws and the frame is ready for automatic wire-wrapping.

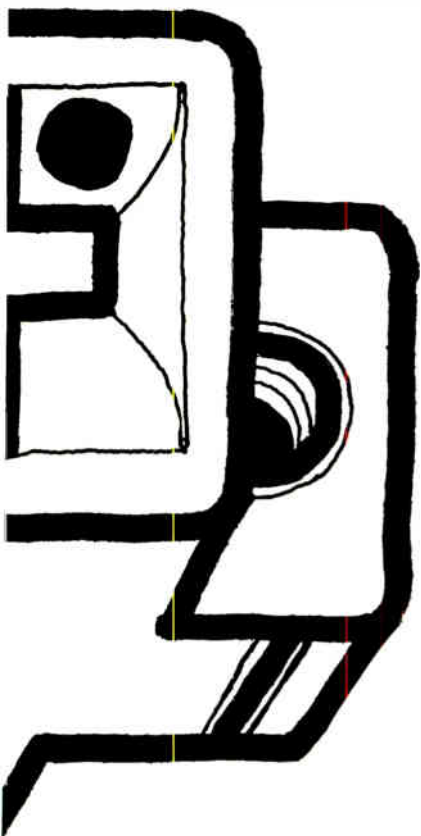

... you go the hard way or not at all with TTL, says Raytheon Semiconductor ...

capacity of 1.5 million dice a month, Paul Sullivan, the marketing director recalls that his company learned the hard way. "When we set out to make SUHL circuits, we decided to make it as easy on ourselves as possible," he says. "We relaxed photoengraving tolerances and the like, but found we were getting rotten yields and marginal performance. We finally came to the conclusion that the low road was a dead end. Sylvania's right: You go the hard way or not at all." Raytheon now reports having achieved wafer yields as high as 37% on production runs.

End of an era

Don Winstead, product marketing manager at Signetics, feels that TTL delivery is no longer a significant problem. He notes that companies are redesigning their circuits to increase yields rather than resorting to tighter process controls. By way of example, he says, the input threshold of a TTL gate depends on the values of the phase-splitter resistors. These resistor tolerances have been adjusted to raise the threshold to afford higher noise immunity. The relation to yield is that the device will no longer trigger on a marginal pulse.

A savvy West Coast source, familiar with the ins and outs of TTL manufacturing and marketing, says Sylvania solved its early photoresist and diffusion problems by going to very fine tolerances. "Second sources have a tougher time making TTL," he says. "And plastics still present some sticky reliability problems that TI seems to have solved. In the main, such difficulties are caused by wire deformation during transfer molding. The temperatures required in this process can cause thermal wire bond strains, ripping them away from the pads."

Some observers, including a source at RCA, which is about to introduce some versions of the 54/74 series, say that TI picked up a reputation for inferior work at the outset of the TTL rivalry because of its desire to get the broad-

est line on the market as fast as possible. But Thomas Thorkelson, a product planning manager at National Semiconductor and an alumnus of TI, disputes the contention that tolerances for the 54/74 series are looser than for SUHL. "Tolerances are not the issue anyway," he says. "And speed is by no means the principal selling point for TTL. The industrial market wants noise immunity and low cost. The totem-pole output (low impedance) is TTL's most important feature."

Pinned down

There's also a good bit of contention within the semiconductor field over the best pin-connection arrangement. "Where DTL was a pretty standardized proposition with regard to pin configurations, the present situation is something of a mish-mash," says a knowledgeable observer. At the moment, TI is promoting the old DTL 930 pinout for dual in-line packages in its 54/74 series; Sylvania is sticking with its original SUHL configuration.

Both have their adherents. A marketing man at RCA, which is going the TI route puts matters this way: "Customers like the pinout arrangement better because

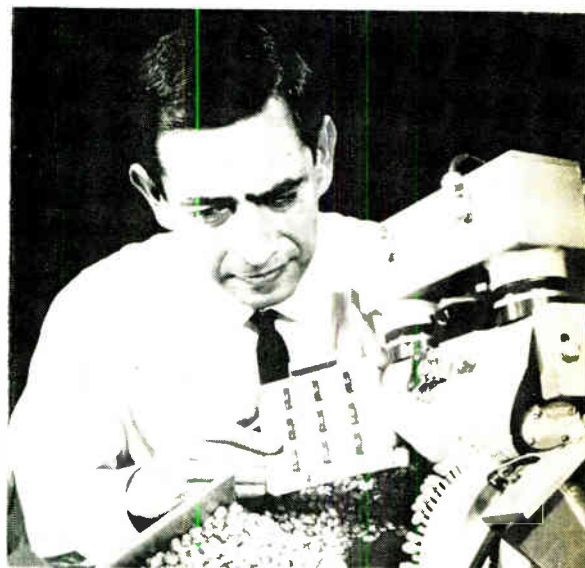

Jobs in industry. Texas Instruments is promoting TTL for such industrial applications as food sorters.

**We do all the work...
you get high yield,
low cost, guaranteed
performance.**

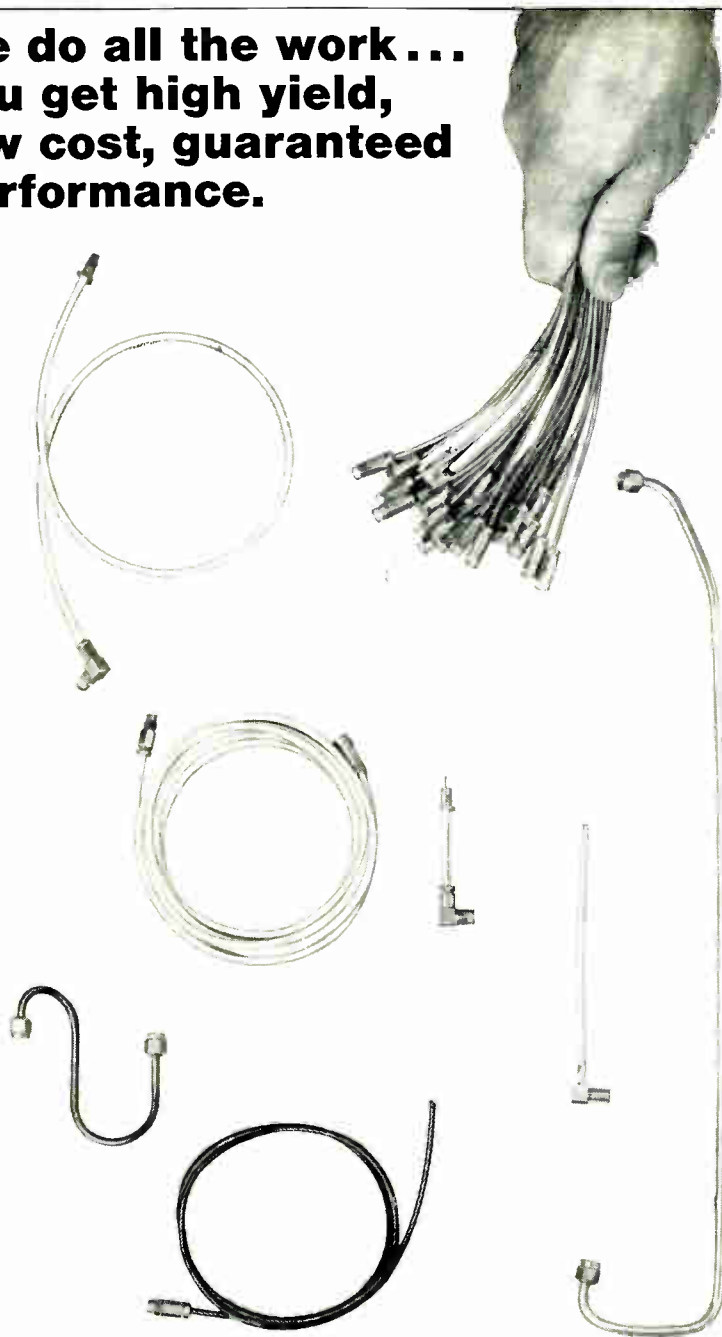

MINIATURE CABLE ASSEMBLIES

As producers of an in-depth line of miniature connectors and semi-rigid miniature coaxial cable, we can make a pretty strong case for ourselves as a source for miniature coaxial assemblies shipped complete with mounted connectors.

Specify any flexible, braided cable or, request our own semi-rigid coax, in sizes from .070 to .350 inches in impedances of 50 and 75 ohms. Specify crimp-type miniature connectors or patented Emlock® compression metal-to-metal fit, in matched impedances. We will cut cable to precise mechanical and electrical

lengths, bend semi-rigid cable to individual requirements, mount selected connectors, test to your established parameters and guarantee performance. All this, at a price lower than your cost if you were to buy your own coax and connectors and do the job yourself. How? Our assembly speed is faster, our yield is greater.

Can we tell you more? Write for full details today: Phelps Dodge Electronic Products Corporation, 60 Dodge Avenue, North Haven, Connecticut 06473

PHELPS DODGE ELECTRONIC PRODUCTS CORPORATION 

**... TI's pinning method
minimizes wiring ...**

the power supply and ground are on the corners of the flatpack instead of in the middle as with SUHL. Sylvania's method does provide a safety factor since there's no danger of burn-out should the device be installed backwards. But the TI method offers another advantage—similar input and output functions on both sides of the package, thereby minimizing and, in some cases, eliminating cross-over wiring."

The TI pinout configuration permitted the company to go after sockets once occupied by DTL devices. But while conceding that the pinning on such TTL assemblies is indeed compatible, Sylvania's Nola says it's impossible in some cases to drop in devices on a one-for-one basis as TI claims. He cites applications where outputs are tied together as an example because, unlike TTL, DTL has no active pull-up network. But such criticism doesn't worry TI unduly. "From the standpoint of board layout, our pinning configuration offers logic designers the highest degree of access," says Weyler.

Because of its experience in molded transistors and sizable production capacity, TI was able to flood the market with plastic-encapsulated devices in its 54/74 series, opening up a number of hitherto untapped markets in the industrial sector. For example, it sold a Midwest manufacturer of dollar-bill acceptors on the merits of replacing a transistorized amplifier, with drift problems, with a decade counter. And Ampex's Mandrel subsidiary which makes food-sorting machinery that must operate in extremely hostile environments is now using a dependable shift register in place of a capacitive brush-charge arrangement with cathode-ray tube that was breakdown prone. TI is inventorying large quantities of assemblies to be able to assure deliveries direct or through distributors within a couple of weeks.

Reaction. Sylvania, Transitron, and a number of others, are racing to make up for lost time. "Sylvania and Transitron devices



Packaging Sales, The Dow Chemical Company, Midland, Michigan 48640.

Try this on your fragile parts.

Pelaspan-Pac® loose fill packing. It weighs 3 to 6 times less than most other dunnage. It won't absorb water. It cuts shipping losses. Because it's highly shock-resistant, and it interlocks to prevent settling. It cuts cleanup, too. Because it's clean, nondusting and noncorrosive. Write for details.



Circle 151 on reader service card

NOW! LOWER BIAS CURRENTS LOWER OFFSETS LOWER THERMAL RATES

in Bell & Howell's Expanding Line of Advanced Hybrid OP AMPS!

Compact, low silhouette
(0.6" x 0.6" x 0.25")

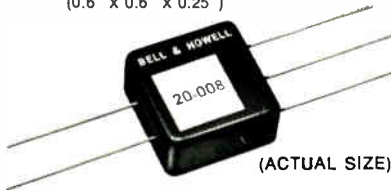

Type 20-008 (FET input Op Amp)
Type 20-007 (general purpose Op Amp.
Same size)

No matter which of these high quality units you select from Bell & Howell's growing line of precision linear circuits, you'll get performance you'd expect only from larger, high price devices . . . and a combination of specifications no other op amps can offer.

You don't have to worry about:

- Offset Trimming
- Compensation
- Short Circuits
- Wrong Connections

with either the Bipolar or the FET Amplifier.

BIPOLAR	TYPE 20-007-A	TYPE 20-007-B	TYPE 20-007-C
voltage offset (max.)	200 μ V	500 μ V	1 mV
voltage offset vs. temp. (max.)	5 μ V/ $^{\circ}$ C	5 μ V/ $^{\circ}$ C	10 μ V/ $^{\circ}$ C
common mode rejection	100 dB	100 dB	100 dB
open loop gain (at 10 kHz)	2,000	2,000	2,000
output current (min.)	5 mA	5 mA	5 mA
PRICE (in quantities of 10-99, any mix)	\$25	\$20	\$15

FET-INPUT	TYPE 20-008-A	TYPE 20-008-B
voltage offset (max.)	1 mV	2 mV
voltage offset vs. temp. (max.)	25 μ V/ $^{\circ}$ C	75 μ V/ $^{\circ}$ C
input bias current (max.)	10 pA	25 pA
common mode rejection	76 dB	76 dB
open loop gain (at 10 kHz)	2,000	2,000
output current (min.)	5 mA	5 mA
PRICE (in quantities of 10-99, any mix)	\$33	\$28

Write or phone for complete technical information on Bell & Howell op amps. Ask for a Bell & Howell sales engineer to call on you to discuss your particular application, and get advance information on how we employ new and proved concepts in hybrid microcircuit technology to bring you a growing family of precision linear circuits.

CONTROL PRODUCTS DIVISION

 BELL & HOWELL

Control Products Division, Consolidated Electrodynamics Corporation,
a Bell & Howell Company, 706 Bostwick Ave., Bridgeport, Conn. 06605.
Telephone: (203) 368-6751. Ask for Mr. Ian Isdale.

seem to be winning the battle of hermetically sealed ceramic-encapsulated IC's, says R. Edward Shaut, marketing manager for digital IC's at Transiron. "But TI was first out with a plastic package and that shaped the market. We hope to be in the market with plastic-packaged SUHL by autumn." Sylvania's plastic offerings are due in two months. But, for the record, Nola professes to be unconvinced about reliability. "We may restrict plastics to certain applications to keep our customers out of trouble," he says. Working both sides of the street, Sylvania is trying to cut prices of its SUHL in ceramic packages. This way, the company's marketing men reason, they could offer equal performance at low cost in what is probably a more reliable package, effectively blunting the thrust of TI's plastics.

Off the beaten track

Not all houses are pushing "pure" TTL in the Sylvania-TI mold. Signetics, for example, offers an 8000 series it calls Designer's Choice Logic, a TTL line that's can- and pin-compatible with DTL. At Fairchild Semiconductor, Ben Anixter, IC marketing manager, says the company is not really pushing TTL. "We're interested in something else—medium-scale integration—because we figure that's the way the wind is blowing in systems work. We figure TTL and DTL will be incidental."

Cost plus. Anixter believes 60% to 80% of a system can now be built with MSI. "This is where the real cost advantage will be," he says. "If you design with DTL or TTL, you're using last year's methods, and you won't be competitive on cost, size, maintainability, or repairability." So the rallying cry at Fairchild is "Systems not sockets." But Anixter concedes Fairchild's 9000 TTL series is on shaky ground. "There'll be a gap in our penetration of the TTL market, but not digital outlets," he says.

Jack Jordan, manager of digital IC marketing at Motorola's Semiconductor Products division, says his company is planning to add a number of complex new functions to its own TTL line. The company, a notable advocate of volume, already second-sources SUHL, and

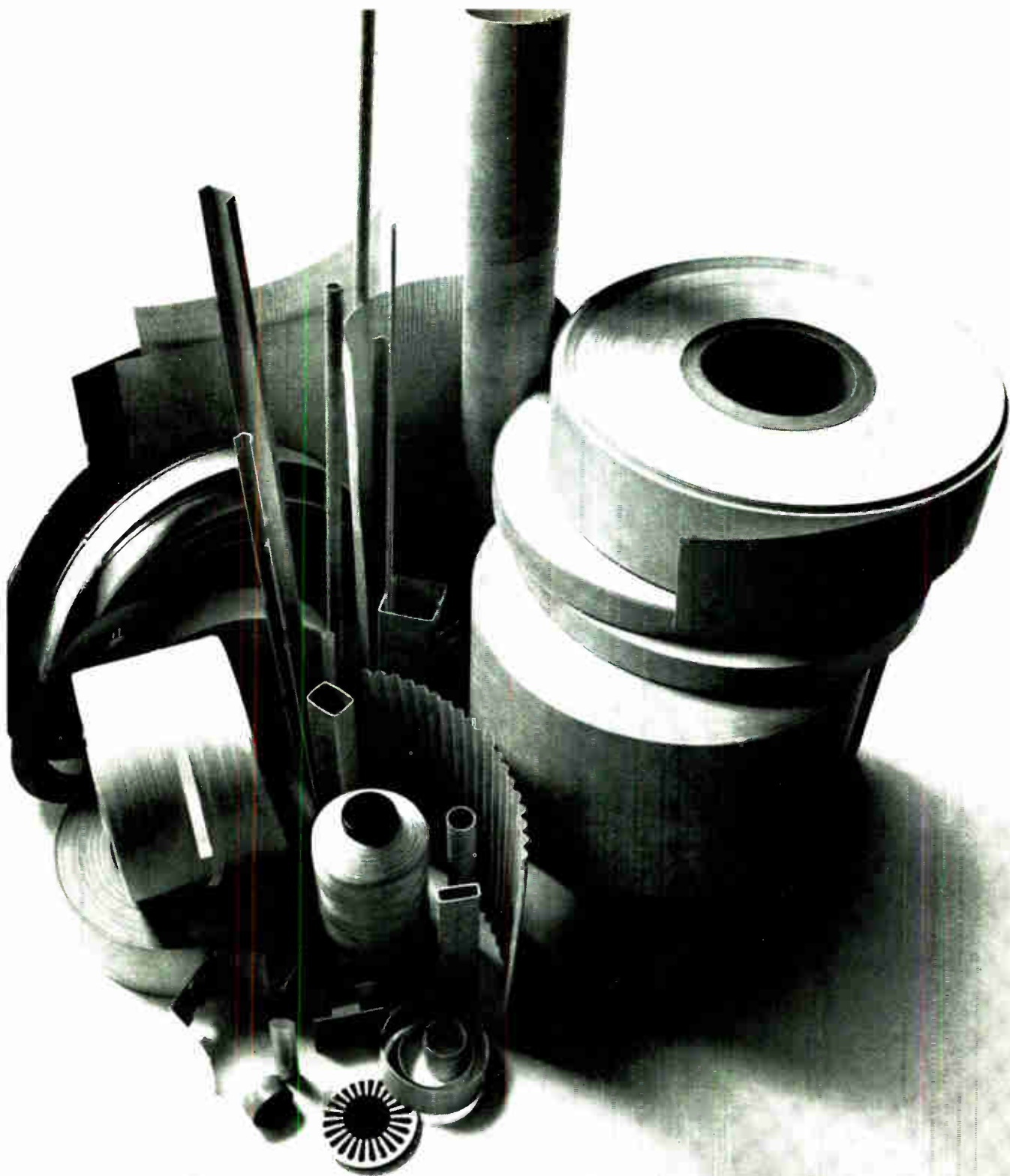

Throw away your insulation handbook. All you need is Nomex.[®]

Nomex[®] nylon paper is the one insulation you can use for just about every application. It won't melt or support combustion—it's UL-rated at 220°C. and it complies with MIL-I-24204. Durable "Nomex" paper won't crack when creased or bent and does not flake. It can be easily slit or punched for close tolerance and can be used in automated operations.

© Du Pont registered trademark

"Nomex" is compatible with all major resins, varnishes and enamels. It is relatively unaffected by moisture, and there are no shelf-life problems.

"Nomex" is available in a wide variety of fabricated forms designed to fit any application. So look to one material—"Nomex"—for all your insulation needs.

To get more information, write:

Du Pont Company, Nomex Marketing,
Room J-6, Wilmington, Delaware
19898. In Canada, write Du Pont of
Canada Ltd. In Europe, Du Pont de
Nemours Int., S. A., 81, Route de l'Aire,
Geneva, Switzerland.

DU PONT **NOMEX**[®]
REG. U.S. PAT. OFF. **NYLON**

This is our new CD-95 Series Regulated DC-DC Converter.



It's the best in its field.

consider:

- 84 fully isolated models —2.8 to 1000 VDC, up to 270 watts;
- Efficiency —60 to 80%;
- Wide input range —21 to 30 VDC (15 to 21 VDC possible with derating);
- 2:1 adjustable output voltage;
- Regulation: Line $\pm(0.05\% + 5 \text{ mV})$, Load $\pm(0.10\% + 10 \text{ mV})$;
- Peak to peak ripple less than $0.5\% + 50 \text{ mV}$;
- Designed to meet MIL environments with EMI provisions per MIL-I-6181-D, operating range -55°C to $+95^\circ\text{C}$.

Best of all . . . the price range is \$125 to \$495, and a sizeable discount schedule reduces this further in quantity!

Write or phone for full information. Incidentally, there is an AC-DC companion line we also want to tell you about.



TECHNIPOWER

A BENRUS Subsidiary

Benrus Center, Route 7, Ridgefield, Connecticut 06877
Telephone 203-438-0333

. . . TTL makers are anxious to exploit complexity . . .

is looking into the possibilities of making devices in the 54/74 series. Its own MTTL 3 offerings have pin configurations "that permit customers the privilege of interchangeability with 930 DTL." Active pulldown is a distinguishing feature of Motorola's line which also uses input diodes to short out the ringing that plagued earlier versions of TTL.

On the drawing boards

Just about everyone in the business is anxious to cash in on the complexity ploy. Jordan of Motorola notes that while TTL was once sold largely on the basis of speed, the availability of more complex functions like binary counters, shift registers, decoders, 16-bit scratchpad memories, and 8-bit parity trees is now the most important element in the field's growth. "TI emphasized complexity early in the game," he says. "And this probably accounts for the gain it's made on Sylvania."

Meanwhile Motorola plans to pad its line with an 8-bit parity tree, a dual 4-bit parity tree, a dual 2-input 4-output gated decoder, a quad flip-flop shift register, and quad flip-flop counters.

Penny wise. TI's Weyler believes that complexity affords economies of production as well as greater reliability. "By replacing six to eight IC packages, you save six times 14 soldered pin connections," he says. "Any time you can do that you're ahead of the game on assembly costs and built-in reliability." Upcoming from TI are coders that accept 4-line to 10-line inputs, and decode them into decimal formats. In addition, the company is working on more complex counters.

National also is moving toward more complex circuits and is about to introduce an MSI circuit, the DM7520/DM8520, a Modulo-N divider with more than 50 gates. This device will divide by any number from 2 through 15. By cascading the circuits, it is possible to divide by very large numbers.

Signetics is beginning to develop more complex TTL devices. In 60 days, it will announce the 8260

Why MIL-C-81511A is the best subminiature you can buy.

Amphenol Astro 348 to this spec provides:

- One-piece molded contact retention system—a design of revolutionary simplicity.
- Ease of handling. If the price of miniaturization is smaller and smaller contacts, the MIL-C-81511A design makes it as easy as possible for the user to handle them. Insertion/removal procedures are easier than with standard sizes.
- Contacts with a true #22 gauge wire fit to accommodate a wire sealing range of .030- to .054-in.
- Contact dielectric separation of .021 inches on .085-in centers, equivalent to existing miniatures with .130-in centers.
- Damage-proof mating. Pins are recessed beyond reach of shells. Closed entry hard socket inserts, probe-proof socket contacts.
- Grounding springs that mate prior to electrical engagement. Shielding for EMI protection.

The MIL-C-81511A family is growing; additional contact sizes and insert arrangements are on the way.

Ask an Amphenol sales engineer or distributor to show you the complete Astro 348 family. Or write Amphenol Connector Div., 2801 S. 25th Ave., Broadview, Ill. 60153.



AMPHENOL

Specify Amphenol electronic components . . . produced in Canada, England, France, Japan, Mexico, United States, West Germany.



Dependable Hermetic Seals For Highly Critical Specs...

(E-I produces for aero-space!)

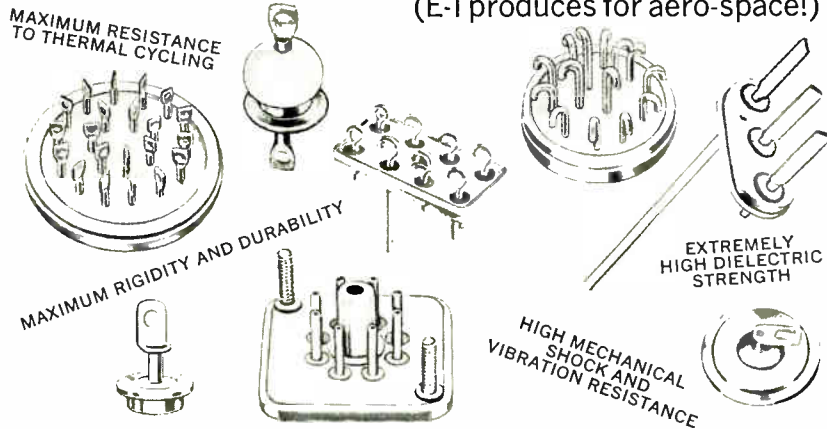

-Must Have Continuous Quality Control Procedures Like This...

(E-I has the strictest!)

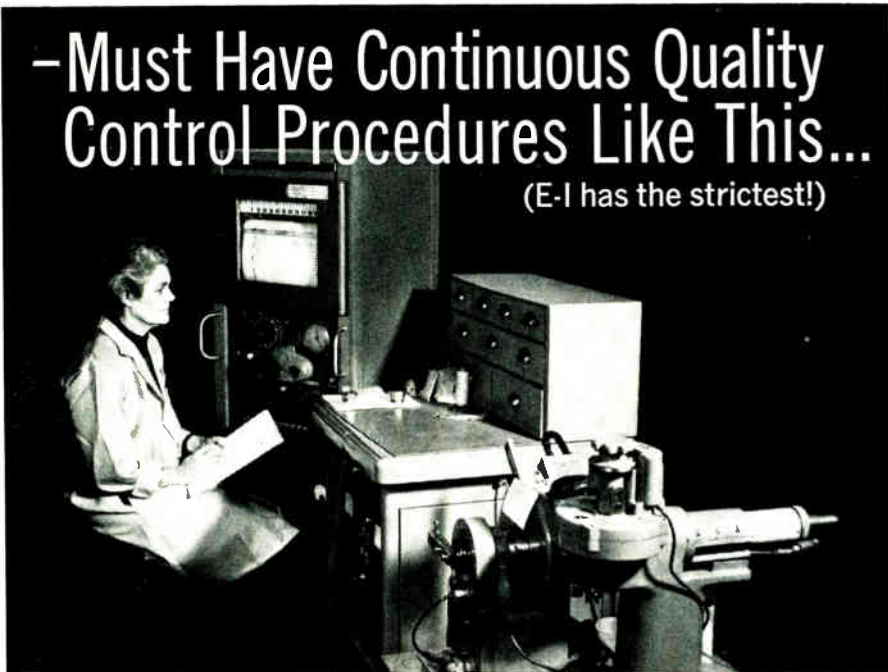

Specify E-I Glass-to-Metal Seals for Sophisticated Applications:

Quality Control at E-I begins with the raw material and follows through to the finished product. The picture above depicts one phase of this program — X-Ray Spectrographic Analysis. The Spectrograph provides a quantitative chemical analysis of the metals, alloys and glasses which are utilized in the manufacture of Electrical Industries' glass-to-metal seals. Continued surveillance of the chemical constituents of materials is just the beginning of the E-I quality control program that assures our customers of the highest quality hermetic seals each and every time.

If you require standard or custom seals or sealing of your own components, check with E-I. Our engineers will gladly make recommendations. Illustrated technical literature is available — call or write today.

- Sealed Terminals and Multiple Headers • Transistor and Diode Bases • Compression-type Threaded End Seals
- Plug-in Connectors • Vibrator Plug-in Connectors • High Voltage Glass-bonded Ceramic Seals
- Hermetically-sealed Relay Headers • Special Application Custom Seals • Custom Sealing to Specifications



Electrical Industries

A Division of Philips Electronics and Pharmaceutical Industries Corp.
Murray Hill, N.J. 07974 — Tel. (201) 464-3200

Patented in U.S.A., No. 3,035,372; in Canada, No. 523,390; in United Kingdom, 734,583; other patents pending.

four-bit adder, which will have 57 gates on an 80-by-100-mil chip. This circuit will come in a 24-pin silicone DIP as well as a flatpack; and it will use much of the gating to achieve full anticipation carry. Most adders, Winstead says, must ripple through the whole chain at a cost of X times the propagation delay of any given segment (about 10 nanoseconds each) to carry. The 8260 senses a carry as it appears, and gates it ahead to the next bit in parallel with the add output. Each bit thus becomes more complex. It's possible to cascade as many of these adders as needed to make up a word; thus 16 packages would be needed for a 64-bit word. In such a case, 64-bit words could be added in 56 nanoseconds.

Transitron is working on a 64-bit monolithic memory chip due early in 1969. The device bears a family resemblance to the 16-bit scratchpad memory developed for Honeywell's big computers but will come in two models—one with internal decoding and one with external decoding. This assembly will probably be marketed in a 22-pin flatpack of DIP.

Also in development are adders to second-source Sylvania lines. There is also a gated full adder on tap at Transitron which would be compatible with TI's 7400 line. Both sorts of devices, says the company, would be at least twice as fast as their Sylvania or TI counterparts.

Before year's end, Sylvania plans to add to both SUIL 1 and 2 lines. One of the new IC's will be a dual D-type flip-flop which Nola says is a useful building block for machines organized along the lines of data transfer registers. This IC is expected during the third quarter of 1968.

There will be many additions to Sylvania's line of functional arrays — comparator IC's, an 8-bit parity generator, a 4-bit fast shift register, binary and decade counters, programmable dividers, and the like. Late this year or early next Sylvania will bring out an up-down counter IC.

"Our philosophy was to round out SUHL and afterward to emphasize complex functions," Nola says. "But during 1969, we'll be looking toward improvements in the TTL format itself."

A NEW FUNCTIONAL APPROACH TO MACHINE AND PROCESS CONTROL!

Struthers-Dunn has analyzed control operations by *function* . . . and reduced them to a family of versatile, solid-state plug-in printed circuit cards like this.

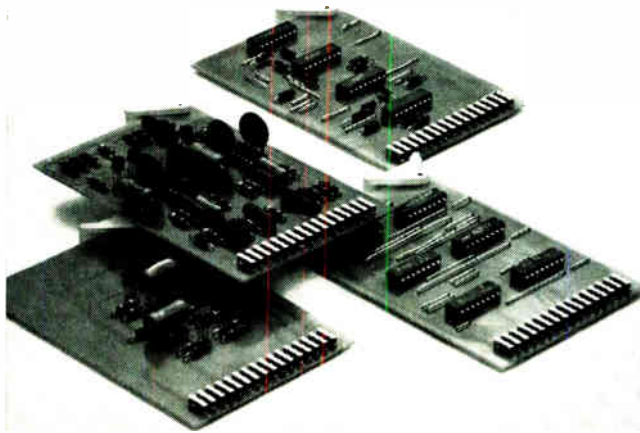

We match cards to your control needs . . . and package them in this compact enclosure with optional magnetic tape programming. Your control costs and headaches are over!

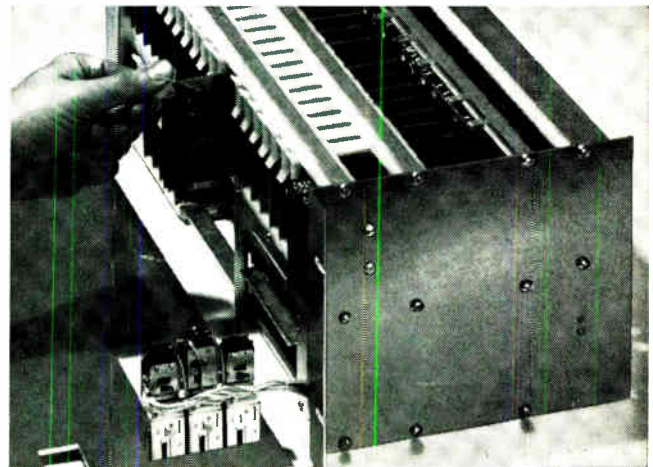

This is the new Struthers-Dunn simplified, money saving approach to the design and use of solid-state control circuitry . . . for both new equipment and machines already in use.

Just tell us your control problems. We will supply a combination of *functional* cards to meet any need . . . control of timing, counting, comparing, load handling, storage and handling of information, and others.

Cards can be combined three ways. *One*, with magnetic tape cartridges in a card-file enclosure, such as our TP-1000, for changeable program cycles. *Two*, in a card-file enclosure without magnetic tape control with a fixed program for single-cycle or repetitive operations. *Three*, as building block sub-assemblies, ready for installation in your own enclosure.

Full details in Bulletin 10010. Send for it today! See how far ahead you can be with *the Control People!*

YOU GET THESE ADVANTAGES

Simplified design technique. No need to be a computer expert. No need to send engineers to special schools. No complicated control circuits.

Easy programming. Magnetic tape with infinitely expandable capacity. Cartridge load. If program changes, just change cartridge.

Easy hook-up. Simple screwdriver connection from TP-1000 to your equipment.

Money-saving maintenance. All solid-state circuitry. Long life. Plug-in cards for fast replacement. Troubleshooter indicator lights quickly identify load circuit faults due to coil failures, etc. All load circuit cards have "fail-safe" feature.

A sales plus. A competitive edge for equipment manufacturers.

Total design service, too. We can provide complete, unbiased service in design and manufacture of control systems for many machines or processes. We offer solid state, reed, plug-in and conventional machine tool relay controls according to needs of the *application* rather than a single approach or catalog.



**STRUTHERS-DUNN, INC.
SYSTEMS DIVISION**

1114 State Street, Bettendorf, Iowa 52722 / Telephone: 319-359-0318



THE QUIET ONE

Introducing series 380, 2 watt potentiometer that is four times as noise free, twice as linear, has many times the cycle life of the Allen-Bradley series J and is still priced competitively.

The Quiet One is Temp-Matured™ ... a breakthrough process of precisely timed, heat maturing created by Clarostat. It makes the entire assembled potentiometer homogeneous and strainfree throughout. It exceeds the requirements of MIL-R-94C style RV4.

Write Dept. 101.
Dover, N.H. 03820.

It's quietly revolutionary.

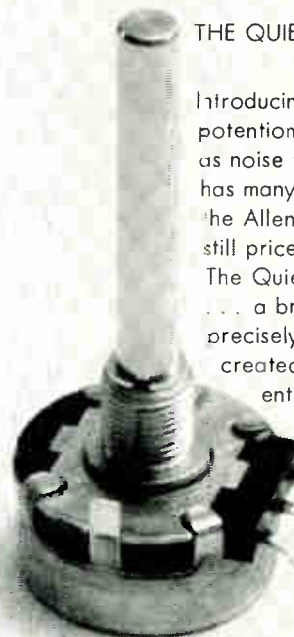

CLAROSTAT

New Components Review



Subminiature case style C reed relay is designed for high speed switching applications. It features axial leads and is available as an unshielded model in Form A and C. Reed package is hermetically sealed, gas filled. Contact rating of Form A is 500 ma and Form C withstands currents up to 100 ma. Aztec Electronics Inc., 163 Liberty Ave., Anaheim, Calif. 92801. [341]

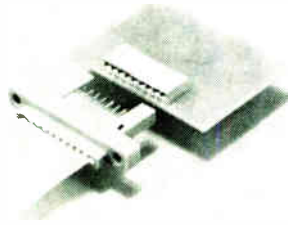

Flexible flat cable connectors called AMP-UNYT use an insulation-piercing crimp to make physical and electrical contact with the cable. Designed for use with cables meeting NAS729 (0.063 in. wide conductors on 0.100 in. centers), these connectors are available in cable-to-cable, cable-to-wire, and cable-to-board configurations. AMP Inc., Harrisburg, Pa. [342]

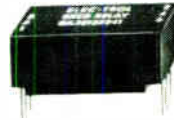

Miniature reed relay RA 3013 was designed to have max. coil resistance providing minimum contact thermal electromotive force and minimum operating power. Contacts can switch dry circuit loads to 10 watts and 0.5 amp; withstand 2,000 hz vibration and 150 g shock. Temperature range is 55° to 85°C. Elec-Trol Inc., Box 304, Northridge, Calif. [343]

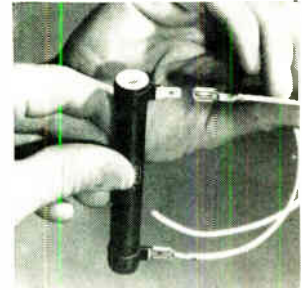

Quick-connect terminals for use in high-volume assembly operations are now available on the type HL wirewound industrial resistors. The terminals can be obtained on round core resistors with core diameters from 5/16 in. through 1 1/8 in. They are also available on flat core styles. Dale Electronics Inc., a subsidiary of The Lionel Corp., P.O. Box 488, Columbus, Neb. 68601. [344]

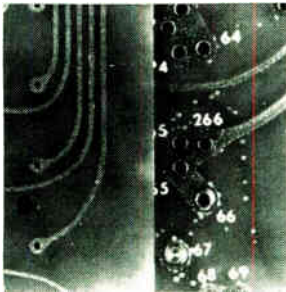

Copper-clad laminate Micarta 65M27 eliminates "measling" (shown at right in photo) in the normal manufacture of printed circuits. It meets requirements of Mil-P-13949. It is translucent light green and ranges in thicknesses from 1/32 to 1/4 in. The laminate is available in standard sheet sizes with copper on 1 or both sides. Westinghouse Electric Corp., Hampton, S.C. [345]



Printed-circuit toroids that are transfer molded of high temperature epoxy resin allow operation at ambient temperatures of -55° to +130°C. They have nickel-alloy leads spaced to match 0.1 in. circuit board grids. Leads may be mounted by soldering or welding. More than 100 values are available, from 0.05 mh to 3 h. Collins Radio Co., Newport Beach, Calif. [346]

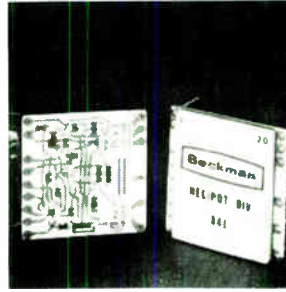

Miniature, hybrid, cermet thick-film ladder switch model 841 is designed for use in digital to analog conversion systems. It offers 4 switching sections, each using 2 bipolar transistors. Rise and fall time is typically 200 nsec, and load range is 0 to 5 ma. Operating temperature range is -55° to +125°C. Beckman Instruments Inc., 2500 Harbor Blvd., Fullerton, Calif. [347]



Dual-in-line IC sockets are available in the W series for hard wiring and the S series for solder type terminations. All types accept any dip with round, square, rectangular, hollow or solid leads with a cross section of 0.008 in. to 0.023 in. and 0.090 in. minimum lead length. Body material meets MIL-M-14F. Robinson-Nugent Inc., New Albany, Ind. 47150. [348]

New components

Solid state thyatron challenges tubes

Billed as a pin-for-pin replacement for mercury devices, it lasts 50 times longer and draws only 100 ma

Until a suitable triggering circuit for silicon controlled rectifiers was developed, mercury vacuum-tube thyatrons resisted replacement by solid state devices. Now, however, engineers at Radiatronics Inc. say they've licked the triggering problem and built a solid state thyatron

that plugs right into the old mercury-tube sockets.

Fredrick Hanby, the project manager, says the device uses an arrangement of SCR's and diodes mounted on a printed-circuit board with the unique triggering circuit, for which a patent is being sought.



Rookie and vet. Solid state thyatron, top, is designed to duplicate mercury tube physically and electrically.

**4.5V, 20 MIL LAMPS
GIVE TUNG-SOL READOUTS
LOW POWER DRAIN,
MINIMUM HEAT,
MAXIMUM RELIABILITY**

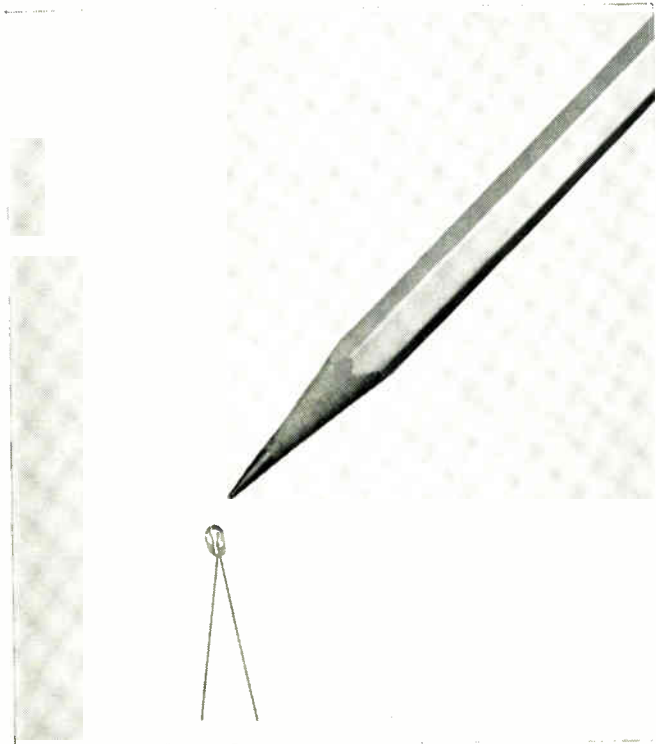

The new T-3/4 lamps used in Tung-Sol readouts, both digital and alphanumeric, provide important performance advantages without loss of effective brilliance. The low-power factor is especially advantageous where energy-source weight must be minimized—such as in aircraft and space vehicles.

Tung-Sol digital and alphanumeric readouts have excellent off-on contrast and a 150° viewing angle. They are designed to be intermixed. Write for brochure T-431, which contains 12 pages of detailed information. Tung-Sol Division, Wagner Electric Corporation, One Summer Avenue, Newark, N.J. 07104.

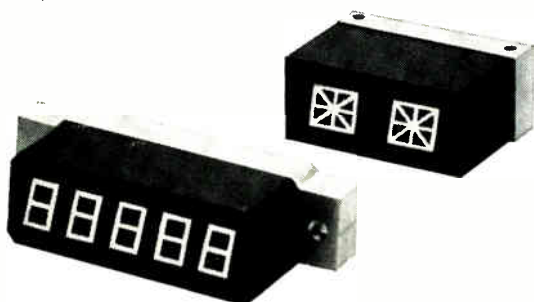

TUNG-SOL®
OPTIMUM CONTRAST
DIGITAL AND ALPHANUMERIC
READOUTS

© REG. T.M. WAGNER ELECTRIC CORPORATION

**... there's no r-f emission
from solid state unit ...**

According to Hanby, the trouble designers faced in building an SCR pin-for-pin replacement was taking the thyatron grid voltage and converting it to a signal that would trigger SCR's.

The Radiatronics unit is mounted in the same kind of plastic base as mercury thyatrons and it is encased in a tube made of blue anodized-aluminum.

Thyatron's have found their greatest use as sources of variable output voltages in power supplies. Hanby says the two principal advantages of the solid state design are increased reliability and ruggedness. "We guarantee a minimum of 10,000 hours mean-time between failures, whereas you would be lucky to get 200 hours from mercury thyatrons. Also, our unit is shock-proof and can withstand all types of hostile environments." Hanby also says the solid state unit doesn't produce radio-frequency emissions.

Radar role. Over a range from d-c to 500 hertz, the thyatron has a maximum peak inverse voltage of 2,400 volts and a maximum forward surge current of 50 amps.

The device draws 100 milliamperes, compared with about 7 amperes for conventional thyatrons, and it generates little heat. After using more than 40 of the units in power supplies for its AN/MPQ-T2 bomb-scoring central radars in tests this year, the Air Force is ordering 1,000 more at \$39 each for use in radar power supplies (including the AN/TSQ-81 and AN/MSQ-35). Civilian prices haven't been established yet.

"Mercury thyatrons go for about \$13," says Hanby. "However, with a guaranteed lifetime 30 to 50 times longer than that of these devices, plus increases in operating efficiency, the service felt the added costs were not out of line."

Five thyatron types can be replaced by Radiatronics devices. Radiatronics SS 2207 replaces the 393A, 6901, 7410, and 395; the SS 2212 replaces the 3C23, VE 967, 714 and 7021; the SS 2213 replaces the 394; the SS 2214 replaces the 627, and the SS 2215 replaces the 629 and RCA 885.

Radiatronics Inc., 18842 Teller Ave., Irvine, Calif. 92664 [349]

Two new tachometers with hardly a ripple

By adding a printed armature tachometer to a printed armature servo motor, PMI has created two unique designs that provide low ripple velocity feedback.

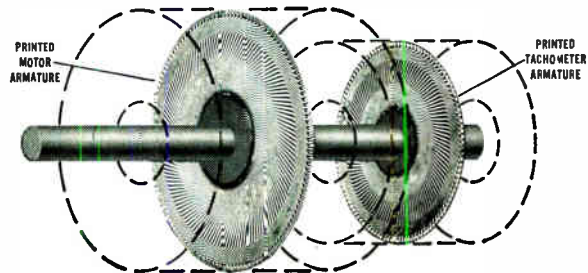
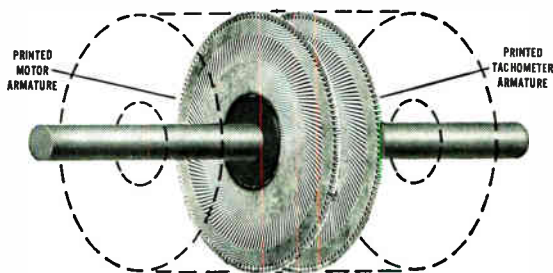

INTEGRAL TACHOMETER — Adds a superior tachometer to standard printed motors **with no increase in motor size**. Tach features include low ripple (5% peak-to-peak at 100 rpm; below 2% over 1000 rpm), excellent linearity and elimination of mechanical coupling and torsional resonance problems. The printed tachometer armature typically has the equivalent of over 100 commutator bars raising the frequency of output ripple far beyond that attainable with conventional tachometers. Ideal for wide speed range velocity servos.

LOW INERTIA TACHOMETER — Designed for high performance incrementing servos where low ripple, low inertia and minimum torsional resonance are necessary. Built as an integral part of the rear shaft extension of any standard PMI motor, this tachometer has a lower ripple output than any comparable tach available today... 1.5% peak-to-peak at 50 rpm. Inertia added by the tachometer is only .0006 oz.-in.-sec.². Couplings and mounting hardware are eliminated by this design and accidental damage to the tach is minimized by housing it in a rugged 1/4" aluminum casting.

Mail this coupon — for information and literature on these exciting new tachometer developments.



PRINTED MOTORS, INC.
GLEN COVE, NEW YORK 11542

Engineering, Manufacturing
and Sales by:
PHOTOCIRCUITS CORPORATION
GLEN COVE, NEW YORK

PRINTED MOTORS, INC.
33 Sea Cliff Avenue, Glen Cove, N. Y. 11542

Dear Sirs: Please send me information on your new printed armature tachometers.

Integral Tachometer

Low Inertia Tachometer

NAME _____ TITLE _____

COMPANY _____

ADDRESS _____

CITY _____ STATE/ZIP _____

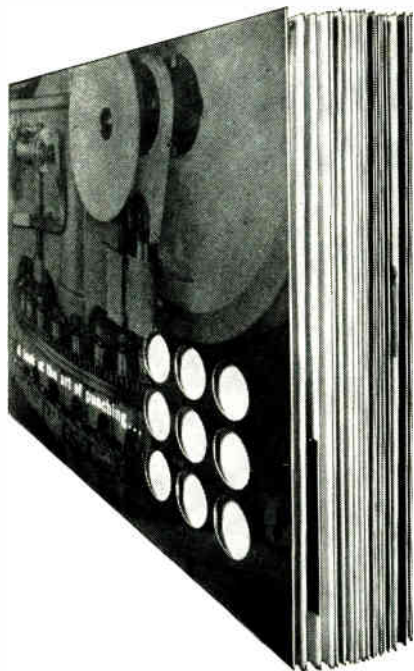

44 brand new pages of helpful punching information

- Six basic punching concepts
- Turret punch presses
- Stylus operated turret punch presses
- OBI punch presses
- Single station punch presses
- New horn punch presses
- Adjustable punch and die sets
- All shapes and sizes of punches and dies
- Template layout machines

Complete information! Illustrations, descriptions, specifications and prices. Ask your distributor for the new 44-page Di-Acro punching catalog or write us.



DI-ACRO

division of



437 EIGHTH AVENUE
LAKE CITY, MINNESOTA 55041

New components

Regulator has .005% control

Thick-film hybrid IC delivers up to 10 watts, has 80-db ripple rejection

Voltage-regulator makers are in for tough competition from Varadyne Inc. This small California firm has developed a regulator that holds a voltage to within 0.005% of a desired level, a figure the company calls 10 times better than that offered by competitive units.

Each of these Varadyne devices, given the family name of Series J, is a thick-film hybrid integrated circuit mounted on an inch-long alumina substrate. The ripple rejection

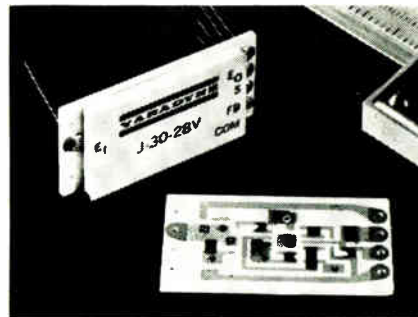

is 80 decibels at 10 kilohertz, and the device can be used from 10 hertz to 600 khz. Peak deliverable power is 10 watts normally, and 24 watts if the regulator is coupled to a 36°C heat sink. The active element in the device is a Motorola operational amplifier.

Three models, covering ranges of 3 to 8 volts, 9 to 21 volts, and 21 to 32 volts, are available with either a fixed or variable output.

Charles Tobias, Varadyne president, lists ripple rejection, percent regulation, and deliverable power as the factors to consider when evaluating regulators. "We beat the competitors on all three counts," he says. "And we're just as competitive in price." In quantities from one to nine the regulator costs \$32.50.

Varadyne Inc., 1805 Colorado Blvd., Santa Monica, Calif. 90404 [350]

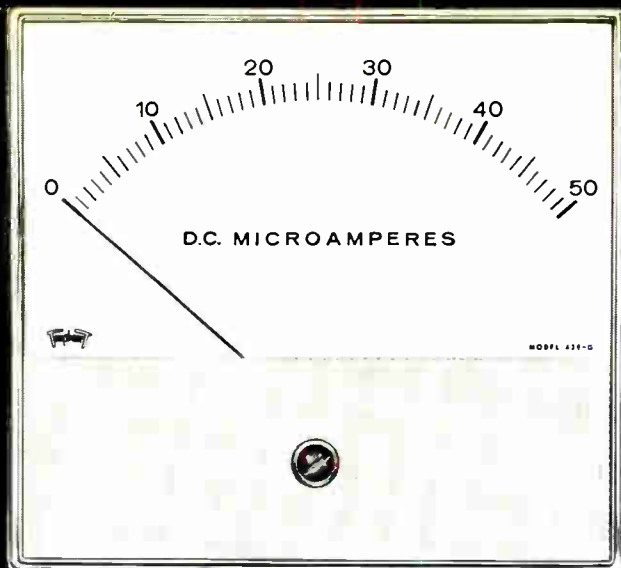

now you see it



now you don't



THE PANEL INSTRUMENT WITH BUILT-IN FLEXIBILITY

TWO NEW SIZES!

5½" and 1½" (Miniature)

TRIPLET

New Triplet G-Series Panel Instruments offer a modern design that features a greater degree of flexibility and interchangeability.

- 1** Two types of mounting are available—conventional flush type or behind-the-panel with a bezel for modern picture window appearance.
- 2** The insert shield on the front of the meter can be custom painted or printed to meet customer's requirements.
- 3** Triplet's famous self-shielded Bar-Ring magnet, with one-piece die-cast frame, in all DC and DC suspension type instruments.

In five popular sizes: 5½" DC and AC; 4½" DC and AC; 3½" DC and AC; 2½" DC and AC; 1½" (conventional flush mounting only) DC and AC rectifier type.

Circle 163 on reader service card

NOW IN FIVE POPULAR SIZES:

1½" (Miniature); 2½"; 3½"; 4½"; & 5½".

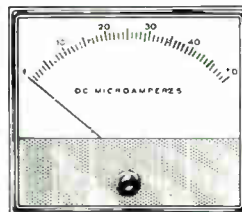
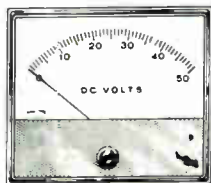

TRIPLET ELECTRICAL INSTRUMENT COMPANY, BLUFFTON, OHIO

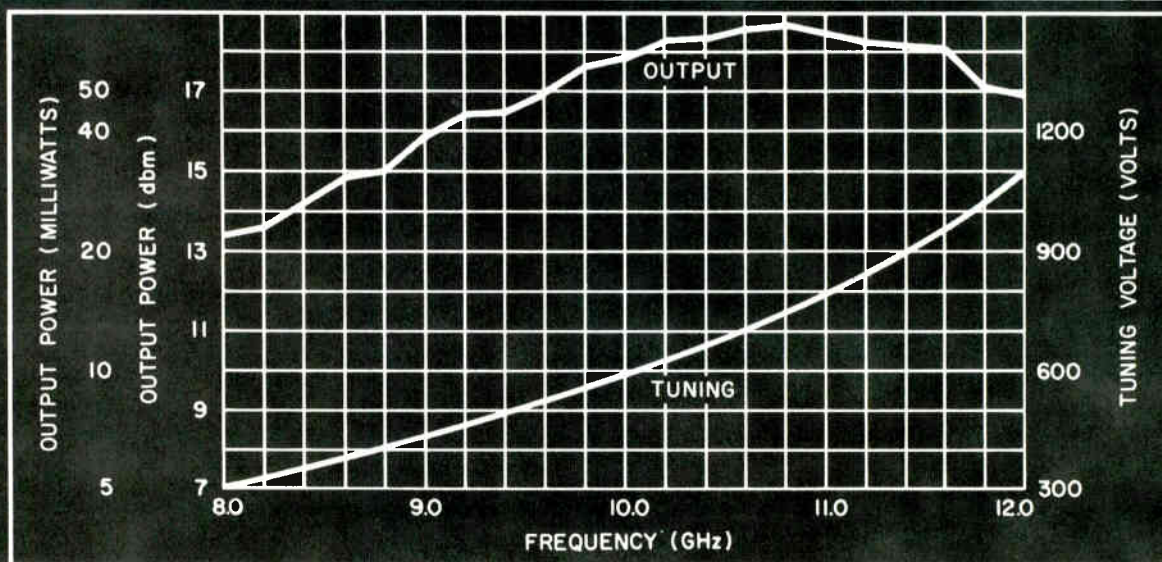

New Sperry X band BWO offers dramatic size/weight savings

Now you can specify the advantages of metal-ceramic BWO's into your own system or equipment; the size and weight penalties connected with glass tubes need no longer be paid.

Sperry's newest BWO is designated SBX-2980. It comes in a 1.5 x 1.6 x 6 inch package, and it weighs only 1.7 lbs., including its focusing magnet. The tube is voltage tunable across the 8.0 to 12.0 GHz range,

and it typically delivers 22 to 80 mW of output. Sperry's minimum output spec is 15 mW. This BWO is fully qualified to airborne environmental specs.

SBX 2980 is now in volume production. Because of that you can expect fastest delivery and unusually attractive prices. For more details or quotation, contact your Cain & Co. representative or write Sperry Electronic Tube Division, Gainesville, Florida, today.

SPERRY
ELECTRONIC TUBE DIVISION
GAINESVILLE, FLORIDA

New Instruments Review

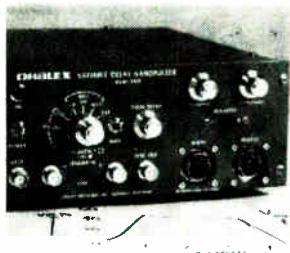

Variable delay pulse generators series 2306 feature bipolar outputs to 50 v, and less than 1 nsec rise and fall time. Repetition rates for all models are variable by front panel control from 1 hz to 1 Mhz, or may be externally triggered to 1 Mhz. Overshoot and undershoot is less than 5% for amplitudes over 2 v. Gralex Industries Inc., 28 Di Tomas Ct., Copiague, N.Y. [361]



High level d-c output (± 1.5 v) linear accelerometer model 100 has an output accurately proportional to the sensed acceleration vector with ranges of ± 1 g to ± 259 g. Power input is 6 ffv d-c. The self-contained transducer measures 1 in. square by $1\frac{1}{8}$ in. high, and weighs approximately 3 oz. Price is \$345. Setra Inc., 12 Huron Drive, Natick, Mass. 01760. [362]

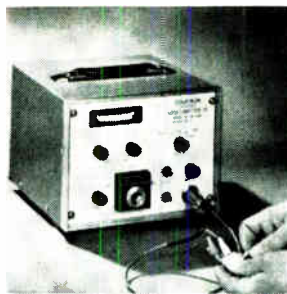

Go/no-go noise limit tester 60-2300 can be used to inspect precision or trimmer, wirewound or film potentiometers. The unit contains a constant current source to energize the wiper and a high input impedance adjustable limit detector to monitor wiper voltage. A panel light indicates when a preset limit is exceeded. Solatron Enterprises, Venice, Calif. [363]



Modulation meter model 409 provides wide carrier ranges—a-m: 3 to 1,200 Mhz; f-m: 3 to 1,500 Mhz—and measures percentages of amplitude modulation in 3 ranges, and f-m deviation up to ± 600 khz in 6 ranges. A-m measurement accuracy is better than $\pm 3\%$ to 5 khz; f-m, better than $\pm 5\%$ to 50 khz. Winslow Tele-Technics Inc., 1005 First Ave., Asbury Park, N.J. 07712. [364]

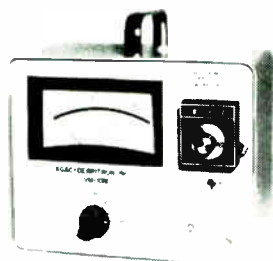

Lightweight vibration monitor model VM-10M can be used with any piezoelectric accelerometer with sensitivities from 1 mv/g to 100 mv/g. Features include high input impedance of 1,000 megohms, 6 full-scale acceleration ranges of 1, 3, 10, 30, 100 and 300 g, and a constant 10 mv/g output. Price is \$395. Agac-Dertriton Inc., P.O. Box 358, Alexandria, Va. 22313. [365]



Dual-range pressure transducers series 200M feature a linearity of better than 1% of full scale. The primary range is the highest pressure range to be measured (0.05 to ± 5 psi); the secondary range is obtained by an internal amplifier and can be as much as 10 times lower, or typically 0.005 psi full scale. Lion Research Corp., 60 Bridge St., Newton, Mass. [366]

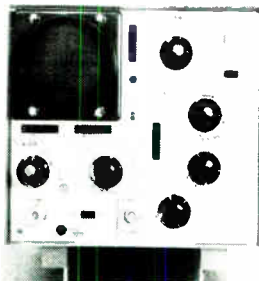

General purpose oscilloscope model 101 is suited for applications on CATV sites, remote communications sites, flight lines, ship-board and field use. It combines 50 mv/cm sensitivity and d-c to 20 Mhz bandwidth. The unit measures 9 x 8½ x 15 in. and weighs 17 lbs. Price is \$665; delivery, from stock. Texscan Technical Products Corp., Indianapolis. [367]



Sine/square wave, true rms differential wattmeter model 4201 offers high resolution and stability designed to continuously monitor and record gyro power. Power range is 0 to 12 w. direct digital reading with 100 μ w resolution. Accuracy (2.5 to 12 w) is 2% of reading for 1 to 0.5 pf loads. Price is \$1,995. NH Research Inc., 1510 S. Lyon St., Santa Ana, Calif. 92705 [368]

New instruments

From Britain, a low-cost averager

Analog system uses 350-picosecond gating circuit to extract repetitive signals from noise, 1,000 times more intense.

Finding a signal buried in noise isn't a difficult task. When the noise is random and the signal repetitious, the noise will drop out when the complete input is integrated for a period that's several hundred times longer than the signal's width. This averaging technique is so success-

ful that engineers are no longer intimidated by high noise-to-signal ratios.

The popular signal averagers, like Nuclear Data's Enhancetron, are digital. But their prices start at about \$5,000. Now a British firm, Aim Electronics Ltd., has built an

analog averager that will sell in the U.S. for \$3,075.

Called the System 7.3, Aim's averager can dig out a signal that's buried in noise 1,000 times its amplitude, as long as the signal repeats and its width is less than 1 second. The 7.3's response is linear for inputs from d-c to 1 gigahertz, after which it gradually drops. At 3 Ghz, the response is off by no more than 3 decibels.

The 7.3 has a gating circuit that opens for 350 picoseconds each time a signal is received. A trigger, which can be either internal or external, alerts the 7.3 each time a signal is transmitted. The gating

Computer Performance; Calculator Price.



WANG 380

640 Program Steps
24 Storage Registers
 $\text{LOG}_e X$, e^x , X^2 , \sqrt{X} , $\frac{1}{X}$, $+$, $-$, \times , \div
Performs Subroutines, Loops,
Branches, Makes Decisions.

\$3795.

No special programming language needed. The Wang 380 learns programs directly from keyboard operations and stores them on plug-in magnetic tape cartridges.

You can tailor system capability to your exact needs with compatible accessories including:

Output Writer, CRT Display, additional Data Storage, Teletype, Trig Pack, and On-line Interface.

There is nothing comparable, anywhere.



Dept. 7H, 836 North St., Tewksbury, Massachusetts 01876 • Tel. 617 851-7311

Call today for immediate trial:

(201) 241-0250	(216) 333-6611	(313) 278-4744	(416) 364-0327	(604) 685-2835	(703) 931-7878
(203) 223-7588	(301) 588-3711	(314) 727-0256	(504) 729-6858	(612) 881-5324	(713) 668-0275
(205) 595-0694	(301) 821-8212	(317) 631-0909	(505) 255-9042	(613) 224-4554	(716) 234-5651
(206) 622-2466	(303) 364-7361	(403) 266-1804	(512) 454-4324	(614) 488-9753	(717) 381-5440
(212) 682-5921	(304) 344-9431	(404) 457-6441	(513) 531-2729	(615) 588-5731	(717) 397-3212
(213) 278-3232	(305) 564-3785	(405) 842-7882	(514) 482-0737	(617) 851-7311	(805) 962-6112
(214) 361-4351	(305) 841-3691	(412) 366-1906	(518) 463-8877	(702) 322-4692	(901) 272-7488
(215) 642-4321	(312) 889-2254	(415) 454-4140	(602) 265-8747	(703) 877-5535	(916) 489-7326
					(919) 288-1695

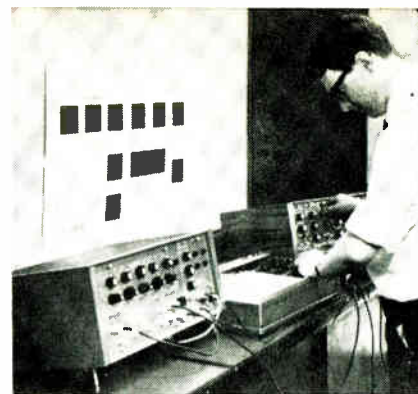

Average performer. The 7.3, shown at left, continually integrates repetitive signal to eliminate random noise.

circuit examines a 350-psec segment of the input and the amplitude of this gated portion is stored in a capacitive memory. Each time a signal is received, the opening of the 350-psec window comes a little bit later than it did on the previous cycle. Eventually, the window moves down the entire waveform and then the process repeats. The amplitudes are averaged in either an internal integrator that has a 0.025-hertz bandwidth or an external integrator. The averager's output can be fed to an oscilloscope, a voltmeter, a storage scope, or an x-y recorder. Aim recommends using a recorder in order to take advantage of the 7.3's linearity.

Aim offers, as an option, an analog-to-digital converter for users requiring a digital output. But this adds \$1,200 to the price of the basic system.

Research tool. Aim's first customers will most likely be medical researchers. Their attempts to measure specific physiological signals are always hindered by the presence of high-level signals from other parts of the body. The 7.3, like other averagers, is already being used in neurological studies on animals.

In a typical experiment, an electrode is placed in a specific spot in the brain and another is placed elsewhere in the nervous system. A stimulating pulse is applied through the first electrode and the second electrode detects the response and feeds it to the averager. The stimulus also acts as the trigger, and is continually applied until the noise is averaged out.

The 7.3 can also be used to detect chemical and nuclear reaction

in 1-1000 MHz work

Voltage tells only half the story

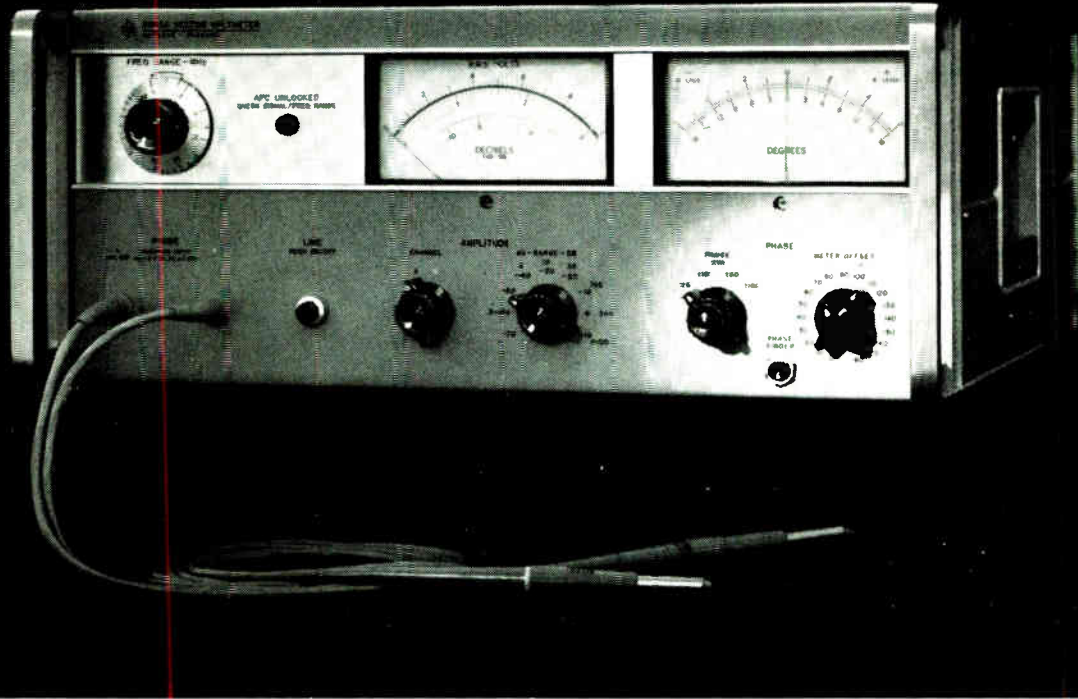

The HP Vector Voltmeter tells all.

"All" means *phase*, the key to every RF measurement. Especially the tough ones like open-loop gain of feedback amplifiers, electrical lengths, resonance characteristics, or filter pass and rejection bands. And this 2-channel millivoltmeter-phasemeter makes them directly, accurately and conveniently.

The Vector Voltmeter covers the frequency range from 1 to 1000 MHz and automatically locks onto the signal anywhere within an octave—no fine tuning required. It's extremely sensitive—full scale 100 μ V. With its 90 dB dynamic range, you can easily measure high gain and high loss networks. It has a 360-

degree phase range with 0.1° resolution.

The 8405A also serves as a "frequency translator." How? By transforming the RF inputs to 20 kHz outputs whose wave shapes, amplitudes and phase relationship remain identical to the original RF signals. You can use these outputs for further analysis with low frequency scopes.

You needn't waste time making a tough RF measurement any longer. The HP 8405A does it faster and more completely than ever before. Application Note 91 tells you how. Just call your HP field engineer for details, or write Hewlett-Packard, Palo Alto, California 94304; Europe: 54 Route des Acacias, Geneva.

MAJOR SPECIFICATIONS, HP 8405A VECTOR VOLTMETER

FREQUENCY RANGE is 1 to 1000 MHz in 21 overlapping octave bands; automatic tuning within each band.

VOLTAGE RANGE FOR CHANNEL A (synchronizing channel), 300 μ V to 1 V rms (10-500 MHz), 500 μ V to 1 V rms (500-1000 MHz) 1.5 mV to 1 V rms (1-10 MHz).

VOLTAGE RANGE FOR CHANNEL B (input to Channel A required) 100 μ V to 1 V rms, full-scale. Full-scale meter ranges from 100 μ V to 1 V in 10 dB steps. Both channels can be extended to 10 V rms with 11576A 10:1 Divider.

PHASE RANGE of 360° indicated on zero-center meter with end-scale ranges of $\pm 180^\circ$, $\pm 60^\circ$, $\pm 18^\circ$, $\pm 6^\circ$. Phase meter OFFSET of $\pm 180^\circ$ in 10° steps permits use of $\pm 6^\circ$ range for 0.1° phase resolution at any phase angle.

PRICE: \$2750.

HEWLETT  PACKARD

RF TEST EQUIPMENT

Circle 167 on reader service card

GCC makes every type of Teflon coated wire you need today. And some you may need tomorrow.

Everyone agrees Teflon[®] insulated wire is more than a match for outer space. But, can you depend on getting it to your plant on time to meet your production schedule?

GCC is ready to meet your needs, wherever your plant happens to be. 51 GCC distributing centers and a nationwide network of manufacturing facilities are ready, willing and able to back up every order. GCC's delivery

policy goes one step further; tell us your needs and we'll be sure to stock your most popular items, so you'll always have a readily available source close by.

For specific data on the scope of our Teflon insulated product capabilities, drop us a line. General Cable Corporation, 730 Third Avenue, New York, New York 10017.

GCC



WE'RE IN THE TEFLON
INSULATED WIRE BUSINESS.
AND WE'RE IN IT BIG.

Teflon[®] is a DuPont trademark

products with short lifetimes, and to clean up signals received in telemetry systems. When not averaging, the 7.3 can act as a sampler, allowing a low-speed scope to display high-speed signals—up to 1 Ghz.

Ling Electronics, which sells the system in the U.S., says the 7.3 is available now and delivery time is 10 to 12 weeks.

Ling Electronics Div., LTV Altec Inc., 1515 S. Manchester Ave., Anaheim, Calif. 92802 [369]

New instruments

Airplane altimeter goes all-electric

Servoed device has analog/digital display; may threaten pneumatics

The way the engineers see it, an all-electric airplane altimeter is superior to the pneumatic units now commonly used. It can deliver more power to the displays, its analog needle movement is less delicate, and it has longer mean time between failures.

All this adds up to high hopes at Sunbeam Electronics Inc. for its new all-electric servoed digital altimeter. The subsidiary of the Sunbeam Corp. developed the unit, which is a counter and pointer, for the Boeing 747 and such advanced aircraft as the McDonnell Douglas DC-10 and Lockheed L-1011 airbuses. Trans World Airlines is the



Twice told. Unit indicates altitude with both a pointer and a digital display.

Hi-G provides the most complete line of *miniature* coaxial relays that meet or exceed the applicable portions of MIL-R-5757/D . . . and at competitive prices. These hermetically sealed coaxial relays have been specifically designed for high frequency RF



switching applications. Their trouble free performance characteristics are a result of Hi-G's long experience in the design and manufacture of sophisticated switching devices. All Hi-G relays are built to withstand extremely tough environmental conditions.

SOLVE YOUR HIGH FREQUENCY RF SWITCHING PROBLEMS WITH THESE QUALITY COAXIAL RELAYS

The following configurations are available:

Dice Cube

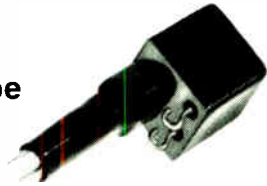

Relay Type	RFC
Size	0.5-Inch Cube
Rated Contact Current	1 Ampere RF
Maximum Weight	0.3 Ounce (without terminations)

Half Size Crystal-Can



Relay Type	RFK
Size	.4 x .8 x .4 inch
Rated Contact Current	1.5 Amperes RF
Maximum Weight	0.37 Ounce (without terminations)

Crystal-Can

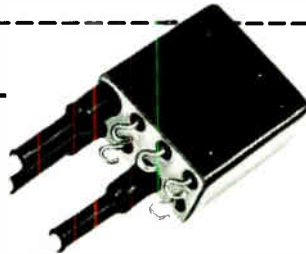

Relay Type	RFB
Size	.875 x .800 x .400
Rated Contact Current	1.5 Amperes RF
Maximum Weight	0.95 Ounce (without terminations)

High Sensitivity

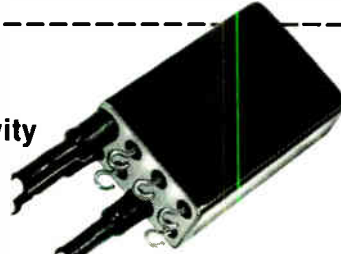

Relay Type	RFBC
Size	1.275 x .800 x .400
Rated Contact Current	1.5 Amperes RF
Maximum Weight	1.0 Ounce (without terminations)

RADIO FREQUENCY CHARACTERISTICS

Frequency Range	0-500 MHz*
Voltage Standing Wave Ratio (VSWR)	<1.1:1 typical
Insertion Loss	0.16DB typical
Characteristic Impedance	50 Ohms†
Crosstalk	-50DB typical

Standard input and output connections from R.F. contacts are RG-196/U Teflon insulated coaxial cable, 6" in length, unterminated. Other lengths, types of cable, or coaxial connector terminations available on special order.

* Usable to 1000 MHz with reduced R.F. Characteristics † Other impedances available on special order

Call, write, or check the reader service card for your copy of Hi-G Product Bulletin 155. Hi-G radio frequency relays are available through Hi-G distributors and, if you need applications engineering assistance, an experienced Hi-G representative awaits your call. Telephone: 203-623-2481.



SPRING STREET & ROUTE 75 / WINDSOR LOCKS, CONNECTICUT 06096

**NOW—
greater
capability . . .
with CEI's
new model
8421**

SIGNAL MONITOR



For CEI's VLF/LF/MF Receivers

CEI's new type SM-8421 Signal Monitor extends the capability of any CEI VLF/LF/MF Receiver, operating from a 2-MHz IF output to provide a visual display of signals in a band around the received signal.

With a maximum sweep width of 50 kHz, the SM-8421 has been designed as an operating accessory for CEI Receivers covering the VLF, LF and HF frequency ranges. Typical are CEI's 354, 355, 356 and 357 Receivers.

All active elements in the Signal Monitor are solid state except for the cathode ray tube, providing high reliability and low power requirements. Crystal filters are used to restrict the input bandwidth for the two narrow sweep widths. The SM-8421 features ease of operation, a high-light output CRT and a built-in crystal marker to indicate the center of the unit's passband.

Supplied in a panel 3.5 inches high by 19 inches wide, the unit provides three selective sweep widths of 50, 15 and 3 kHz, with associated resolutions of 2500, 1200 and 250 Hz. This provides sufficient definition to view low modulation rates.

Call or Write for Specifications



SUBSIDIARY OF WATKINS JOHNSON



COMMUNICATION ELECTRONICS

6006 Executive Blvd., Rockville, Md. 20852 • 301/881-3300 • TWX 710-824-9603

**. . . altimeter is fed by
plane's computer . . .**

first carrier to specify Sunbeam's version for its 747's, making it the first airline to switch to an all-electric servoed altimeter. Conventional airplanes have the venerable pneumatic units or servopneumatic models with pneumatic as the standby mode.

Plugs in. The Sunbeam altimeter, type 9802-07, operates off the plane's central air-data computer. Its pointer is the conventional continuous-moving analog type. In the face of the unit is the five-digit electromechanical counter, moving in ± 20 -foot increments, snapping-in in less than 100 milliseconds. Digits are $\frac{3}{8}$ inch for 1,000's and 10,000's, $\frac{1}{4}$ inch for units, 10's and 100's. The altimeter accepts analog synchro information and is compatible with Arinc specs 545 and 565 for air-data computers. The face presentation can be changed to provide a continuous digital display, or ± 50 -foot increments, or whatever special features the customer wants.

When altitude is negative, a flag covers the digital display.

There are, however, several problems. Sunbeam still must convince airlines that the all-electric unit is more reliable operating from the central computer than the pneumatic models operating from static pressure ports. Also, the new altimeter could cost several thousand dollars more than airlines are used to paying for altimeters.

But in the words of Sunbeam marketing manager Andrew Barbaccia, the clincher is the way the new device licks one of the peskier problems encountered with pointer units now in use—human error. "Pilots now misread the figures—100 feet instead of 1,000, or 10 instead of 100. Digital readout eliminates this," he says.

The unit is accurate to within ± 5 feet over a range from $-1,000$ to $+50,000$ feet, and has 25,000-feet-per-minute slew rate.

A 26-volt, 400-hertz signal and a 5-volt, a-c or d-c, signal are needed to drive it. The weight is 4.5 pounds and the maximum length is 7 inches.

Sunbeam Electronics Inc., Fort Lauderdale, Fla. 33304 [370]

Let us throw you a curve

If you've problems with LC circuits, Magnetics' new Iso-Q contour curves speed ferrite pot core selection.

No more squinting at tangles of curves on log paper to find the ferrite pot core size you need. Magnetics' new Iso-Q contour curves let you zero in on your target size in seconds. We've plotted over 100 of these time-savers to handle more than 90% of normal design

requirements. They're all contained in our new Ferrite Cores Catalog, first of its kind in the industry.

Magnetics' high purity ferrites cover frequencies up to 2 megahertz. Linear temperature coefficients on 750, 1400 and 2000 permeability materials are guaranteed from -30° to $+70^{\circ}\text{C}$. Flat temperature coefficient on 2300 perm material is guaranteed from $+20^{\circ}$ to $+70^{\circ}\text{C}$.

Magnetics' wide selection of ferrites comprises eight international standard sizes and five additional sizes—175 part numbers for design freedom. We can give you quick

delivery from our large inventory that includes both gapped and un-gapped cores in your most asked-for sizes. Of course, we provide one-piece clamping hardware for most sizes. Finally, we offer you a complete choice of tuning assemblies, bobbins and shapes—toroid, E, U and I.



Get your set of our new Iso-Q Curves. You'll like their curvilinearity. Write on your letterhead to Magnetics Inc., Dept. EL-101, Butler, Pa. 16001. Please include your title and/or job function.



MAGNETICS inc.
®

Tape, Powder, Bobbin, Ferrite Cores • Laminations • Photo-etched Parts • Specialty Metals • Engineered Control Systems

An Important Announcement
to Users of Ku-Band 1N78 Diodes

Microwave Associates has developed, is manufacturing, and stocking coaxial Schottky-barrier mixer diodes electrically and mechanically superior to, and interchangeable with, standard 1N78 diodes.

Broadband. 12.5 to 17.5 GHz.

10 ergs burnout.

6.5 dB noise figure.

Batch photoetching and deposition techniques guarantee reproducibility and reliability.



1N Equivalent	MA Model Number	Max. Noise Figure (dB)	Burnout (ergs)
None	MA-4861H	6.5	10
1N78G	MA-4861G	7.0	10
1N78F	MA-4861F	7.5	10
1N78E	MA-4861E	8.0	10
1N78D	MA-4861D	8.8	10
1N78C	MA-4861C	9.5	10



MICROWAVE ASSOCIATES
Burlington, Massachusetts

Offices: Northwest Industrial Park, Burlington, Mass.
3605 Long Beach Blvd., Long Beach, Cal.

Subsidiaries: Microwave Associates (West) Inc., Sunnyvale, Cal.
Microwave Associates, Ltd., Luton, Beds, England.

New Subassemblies Review

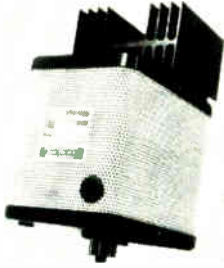

Four a-c to d-c plug-in power supplies have a current rating of 3 amps at output voltages ranging from 6 to 10 v. Line regulation is $\pm 0.05\%$ and load regulation is either $\pm 0.5\%$ or $\pm 0.25\%$ depending on the model. Designed for use in an ambient temperature range from 0 to 55°C, the units require no additional heat sinking. Acopian Corp., Easton, Pa. 18042. [381]

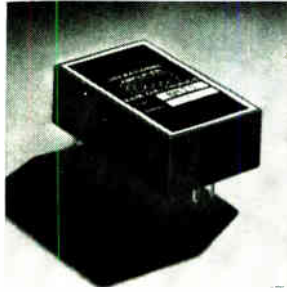

Differential operational amplifier KM25 is internally compensated and has a full power output of 15 khz at +10 ma and 100 v. Stability is 10 uv/°C. Gain is 200,000 at rated load (106 db). The unit is designed for instrumentation, control and computation applications. Price (1 to 9) is \$50; availability, from stock. K&M Electronics Corp., 102 Hobart St., Hackensack, N.J. [382]



Magnetic core memory model DC-32 is a medium speed 3D unit with 4,096 and 8,192 word basic modules available from 4 to 26 bits in 2-bit increments. Full cycle time of typical 4096 x 8 unit is 1.5 μ sec and will vary up to 40% in larger configurations. Access time is 600 nsec. Prices start at \$3,350. Datacraft Corp., P.O. Box 23550, Ft. Lauderdale, Fla. 33307. [383]

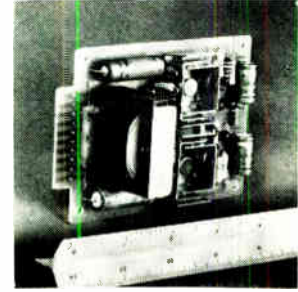

Miniature power supplies have been developed for use with integrated and discrete component operational amplifiers. Model 2.15.50 has dual output current of 50 ma and costs \$35 (1 to 9). Model 2.15.100, with dual output of 100 ma, sells for \$48 (1 to 9). Both measure 3 in. wide x 4.5 in. long x 1.5 in. high. Semiconductor Circuits Inc., Woburn, Mass. [384]



Variable voltage bench supply model BP-118 has an output of 0 to 34 v at 1.5 amps. Regulation is mv or 0.01% with ripple a low 250 μ v. Voltage and current output are continuously monitored by two taut-band meters. The unit meets MIL Specs and is completely short-circuit proof. Price is \$118. Power/Mate Corp., 163 Clay St., Hackensack, N.J. 07601. [385]

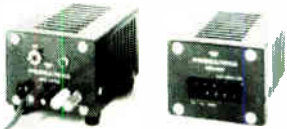

Dual output power supply NPS-300 features separate positive and negative power outputs. Each output is adjustable to between 12 and 18 v d-c at any load between 0 and 30 ma each. Low ripple and noise with fast response time allows unrestricted use in sensitive circuitry. Regulation is to $\pm 0.05\%$ for load and line. Philbrick/Nexus Research, Dedham, Mass. [386]



Solid state device model 678 converts 3-wire synchro input to linear d-c voltage at high speed. It provides an output from -10 to +10 v linear to angles from 0° to 360°. It samples as many as 100 synchros 25 times per sec each in multiplexed systems. Unit costs \$1,125 (1-9), is available on a stock to 10 days basis. Transmagnetics Inc., Flushing, N.Y. [387]



Pulse amplifier model 1002A is designed for MOS driver applications. With a +2 to 5v pulse into its 50 ohm input, from a word or pulse generator, and a -22 v d-c supply voltage, it supplies a pulse with a minimum of -15 v into a 200 ohm load with 50 pf across its output. Unit measures 1 x 2½ x 5 in. Price is \$150. Multi-Phase Electronics, Van Nuys, Calif. [388]

New subassemblies

Budget-price magnetic-tape transport

Unit is intended to replace paper tape in small computers; frequency-independent detection method is used

With a basic computer and memory costing as little as \$6,000, even a small engineering company can afford to buy its own. But because high-speed input and output subassemblies are costly, most users of low-cost systems rely on a teleprinter and its slow integral paper-

tape punch and reader.

A Texas firm, however, has developed a magnetic-tape unit that speeds input and output without straining the user's budget. The company: International Computer Products. The unit: Model 200. With read and write speeds of



4,000 bits per second, the Model 200 is 50 times faster than teleprinter punching and reading. This 4,000-bit speed is about the same as that of a typical paper-tape reader, but considerably faster than a typical paper-tape puncher. The Model 200 is priced at \$1,300.

There are, of course, other rela-



We mechanized thin-film coating

when we perfected our Fast-Cycle Coater

Even unskilled operators can produce consistently uniform, high-quality products at high production rates with automated Airco Temescal Fast-Cycle Coaters. This is because every step in the cycle is preset, every step is automatically controlled, and the cycle can continue only after each programmed step is completed. Rejects are practically eliminated. Check these features:

- The automated cycle is reproducible.
- The coating chamber, sources, and feed material are under continuous vacuum at all times.
- Elimination of repeated pump-downs results in fewer contaminants, purer coatings.
- Evaporant may be replenished without interrupting operation.
- Efficient rate-monitoring system can be used for precise control over film thickness.
- The rotating substrate holder assures piece-to-piece uniformity.
- Substrates may be heated to exact specified temperatures for more effective coating.
- Coated substrates can be cooled in vacuum and/or in inert gas.
- Thoroughly proved electron-beam heat sources can evaporate elements, alloys, refractory metals and dielectrics.

The Airco Temescal Fast-Cycle Coater, Model FC-1100, replaces eight bell jars and seven operators. Why settle for less? Write for details.

AIRCO Temescal

A DIVISION OF AIR REDUCTION COMPANY, INCORPORATED
2850 Seventh Street, Berkeley, California 94710 Telephone 415 841-5720

... system operates with existing software ...

tively low-priced magnetic-tape transports. The Digital Equipment Corp., for example, introduced its TU-55 more than two years ago for small computer systems that lack disk, drum, or conventional magnetic-tape subsystems. With a data-transfer rate of about 100,000 bits/second, the TU-55 costs \$2,300.

Substitute. But W.A. Roessl, International Computer president, points out that his firm isn't aiming at the magnetic-tape transport market. The company is offering the Model 200 as a replacement for paper-tape units. It can be driven from existing paper-tape software.

Connectors and interface circuits to match the 200 to most computers are optional. The tape transport measures 17 by 14 by 3½ inches, and weighs just 18 pounds.

The unit employs a frequency-independent method of sensing recorded 1's and 0's. Two tracks are recorded on the tape: a clock track and a data track. To detect data bits, the output from one track is beat against the other, the phase difference indicates a 1 or a 0. Inexpensive oscillators are used—frequency stability and accuracy aren't critical; low-cost tape-drive motors are used too because large variations in tape speed are tolerable. Roessl says that tapes recorded from a 50-hertz power line have been successfully played back at 60 hz.

Tape is contained in standard cassettes, each holding as much as 360,000 eight-bit characters—180,000 on each side. Rewind time is less than 30 seconds. The transport has two tape decks so that tapes can be duplicated or modified, or reading and writing can be done at the same time.

The input levels are +2 to +5.5 volts for a one, and -1.5 to +0.8 volts for zero. At the output the levels are +2.4 to +5.5 v for a one and 0 to +0.45 v for a zero.

Elco varicon connectors are standard on the unit but other types are available.

International Computer Products, Dallas, Texas 75229 [389]

If the world's biggest snap-switch buyer wanted a single source...

there are only two companies he could call

CHERRY IS ONE OF THEM. That's right . . . Cherry. Because Cherry's line of snap action switches is one of the most complete in the industry.

In addition, Cherry can provide thousands of switch variations at little or no extra cost (in some cases, at less cost than that of a standard type).

In the past 15 years, Cherry has supplied well over 100 million switches in a variety of sizes, shapes and operating characteristics for O.E.M. product applications.

It's a good bet that the Cherry switch you will be specifying has already undergone the rigorous field testing you demand.

If you want further proof, write for a sample switch today.



S30-50W OPEN TYPE
MINIATURE



E61-10H LEVER
SUBMINIATURE



E33-00K ROLLER
MINIATURE



E51-00E LOW TORQUE
ROTARY ACTUATION



E34-00J PUSH-BUTTON
MINIATURE



E19-00R DOUBLE
POLE RESET TYPE

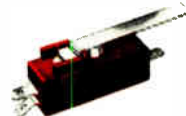

E13-00H SINGLE
POLE LEVER TYPE



S36-40E DOUBLE
POLE MOMENTARY TYPE

CHERRY



CHERRY ELECTRICAL PRODUCTS CORP. 1656 Old Deerfield Road, Highland Park, Illinois 60035

WE SPECIALIZE IN CUSTOM THIN FILM MICROCIRCUITS

Here Are A few Specialties . . .



We have been producing custom hybrid thin film circuits since 1960, pioneering in a number of techniques and processes that enable us to offer a range of digital and analog circuits with short lead time and low initial set-up cost.

Whenever you require special circuit functions, flexible interconnection, high frequency, precise resistor tolerances and close temperature tracking characteristics, consider our custom thin films and functional modules. Contact Joe Crist at (213) 346-6000 today or write to:

MICROELECTRONICS OPERATION



THE BUNKER-RAMO CORPORATION
DEFENSE SYSTEMS DIVISION
8433 FALLBROOK AVENUE • CANOGA PARK, CALIFORNIA 91304

New subassemblies

Memory stacks up as a rugged item

Read-write unit has
a 1,280-word capacity,
can take 30-G shocks

Makers of conventional computer memories concede that the advent of large-scale integration could make solid state units a competitive threat to their own products. However, as long as volatility is a problem with active memories, the conventional varieties will command a healthy portion of the market. So the Librascope group of General Precision Systems Inc. had no qualms about going ahead with its 64,000-bit, woven plated-wire stack.

The Librascope 64K WPW is a 10-plane stack; each plane has 128 50-bit words, for a total of 1,280 words. At 2½ pounds, it weighs about as much as a comparable core memory but offers several advantages, according to Librascope engineers.

The big difference, says Ralph Koerner, engineering head of the plated-wire-memory department, is that the Librascope unit is a nondestructive readout memory. "It would take a pretty complex core to duplicate this," he declares, "and the core memory would still be slower. The read cycle for our memory is 150 nanoseconds, and the write is about 200." The typical cycle time of an equivalent core memory would be between 1 and 2 microseconds, Koerner estimates.

James Cade, a Librascope pro-

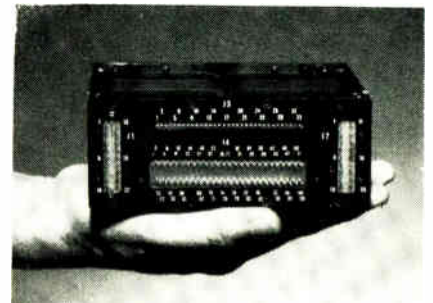

Tough customer. Memory was designed to withstand vibration and severe shock.

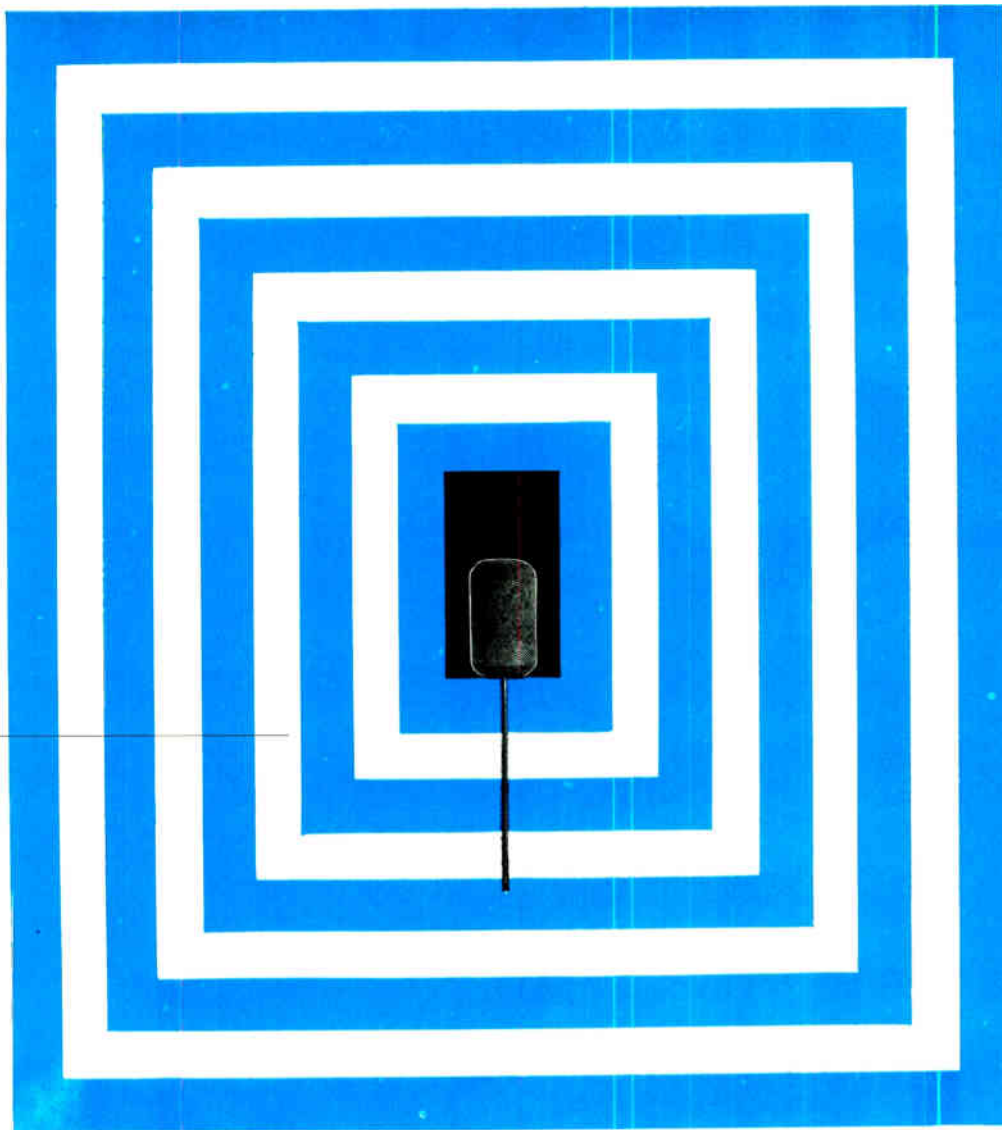

squeeze powder!

Fansteel's "FD" capacitor grade tantalum powder cuts anode size...capacitor cost. Yet improves electrical parameters.

How's that for putting on the squeeze! Compare standard with FD powder. You'll see how FD reduces material cost 35-45% per anode . . . how high purity achieves maximum capacitance without sacrificing electrical properties . . . how low density FD anodes reduce impregnation problems!

As a result of new powder making techniques, you can have smaller, more economical medium and high voltage capacitors. Fansteel FD powder is available in finished anodes or bulk powder form.

Your Fansteel Sales Engineer has detailed technical data. Ask him . . . or write us for your copy.

grade of Ta Powder	Standard	Fansteel FD
weight	4.4 gm	2.3 gm
density	10.5 gm per cc	8.5 max. gm per cc
CV rating	7000	7000



FANSTEEL INC.
NUMBER ONE TANTALUM PLACE
NORTH CHICAGO, ILLINOIS 60064

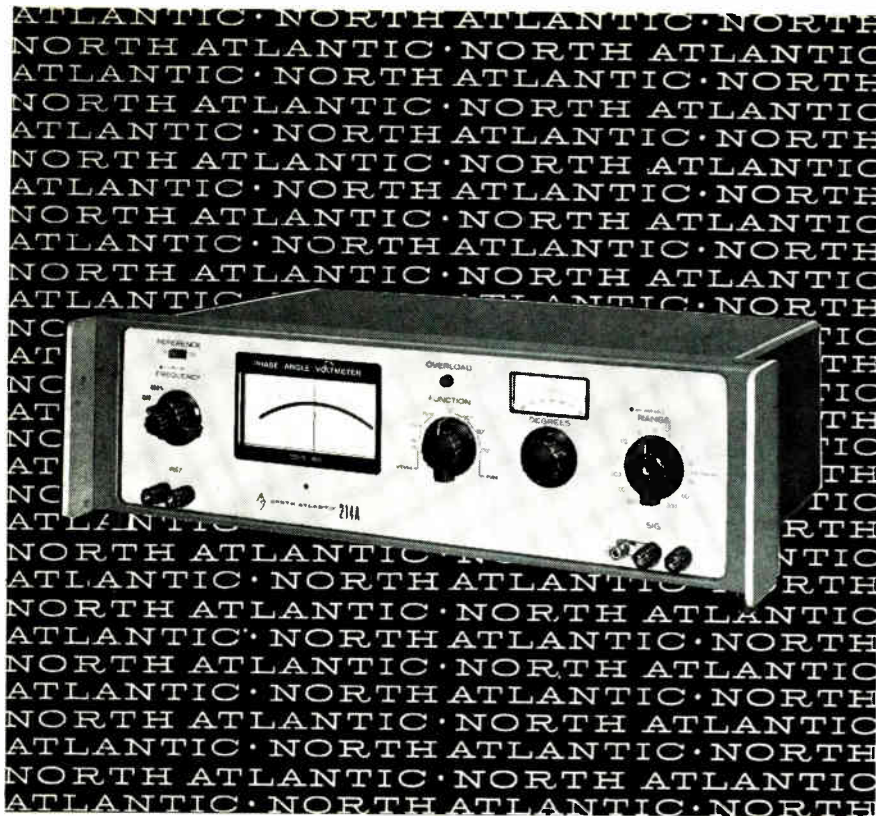

introducing a new versatile phase angle voltmeter for production test

North Atlantic now brings you a new group of solid-state Phase Angle Voltmeters for precision phase-sensitive nulling applications in production test and ground support equipment.

Designed for versatility, they feature measurement of the vector components (including phase) of complex AC signals at 4 discrete frequencies from 30Hz to 20KHz. Operating frequencies can be rapidly changed without calibration by direct plug-in replacement of frequency modules and harmonic rejection filters. Full operating performance is maintained over a bandwidth of $\pm 5\%$ and with 10X signal input overload.

The unit illustrated is the Model 214A. Also available are the Model 214B with reference isolation, and Model 214C with both signal and reference isolation.

North Atlantic's sales representative in your area (see EEM) can tell you all about these units as well as other Phase Angle Voltmeters and Phase Sensitive Converters.



NORTH ATLANTIC industries, inc.
TERMINAL DRIVE, PLAINVIEW, NEW YORK 11803 • 516-681-8600

... nondestructive memory
draws only 12 watts ...

ject engineer, notes that the stack is suitable for the aerospace environment. It was built to take the shock and vibration encountered by missiles, Cade says, and it meets many of the requirements of mil specs E-5400 and E-8189, and military standard 810.

Put to the test. The memory has undergone acceleration tests up to 30 G's for five minutes in each direction of orthogonal axes. It has also withstood three half-sine shock pulses of 30-G amplitude for 8 milliseconds along its orthogonal axes while operating, and a half-sine shock pulse of 530 G's while off. In addition, random vibration loads of 17 G's rms have been applied for five minutes along each axis while the unit was operating. Operating temperature ranges from -40° to 85° C. Librascope had these tests performed by an independent laboratory.

As for power consumption, the WPW draws only 12 watts when used in a 200-kilohertz system. Koerner says an equivalent core memory would consume three to 10 times that amount of power, and adds that, "the low level of power consumption derives from the short operating cycle, and the fact that the memory doesn't have to rewrite."

Operating currents for the device are 650 milliamps $\pm 10\%$ for word write, 65 milliamps $\pm 10\%$ for digit write, and 230 milliamps $\pm 5\%$ for word read.

The stack is 4.6 by 5.7 by 2.3 inches and has word-selecting diodes to minimize external connections. Each of the 10 planes is 5.3 by 3.7 by 0.15 inches. Like all other Librascope plated-wire memories, the WPW is woven on a specially modified, automated textile loom.

The company says the memory's price will depend on the characteristics and volume requested by customers. The company feels that no core can duplicate the stack's features, so engineers will pay more per bit for a stack than for a core memory.

Librascope Group, General Precision Systems Inc., 1100 Frances Court, Glendale, Calif. 91201. [390]

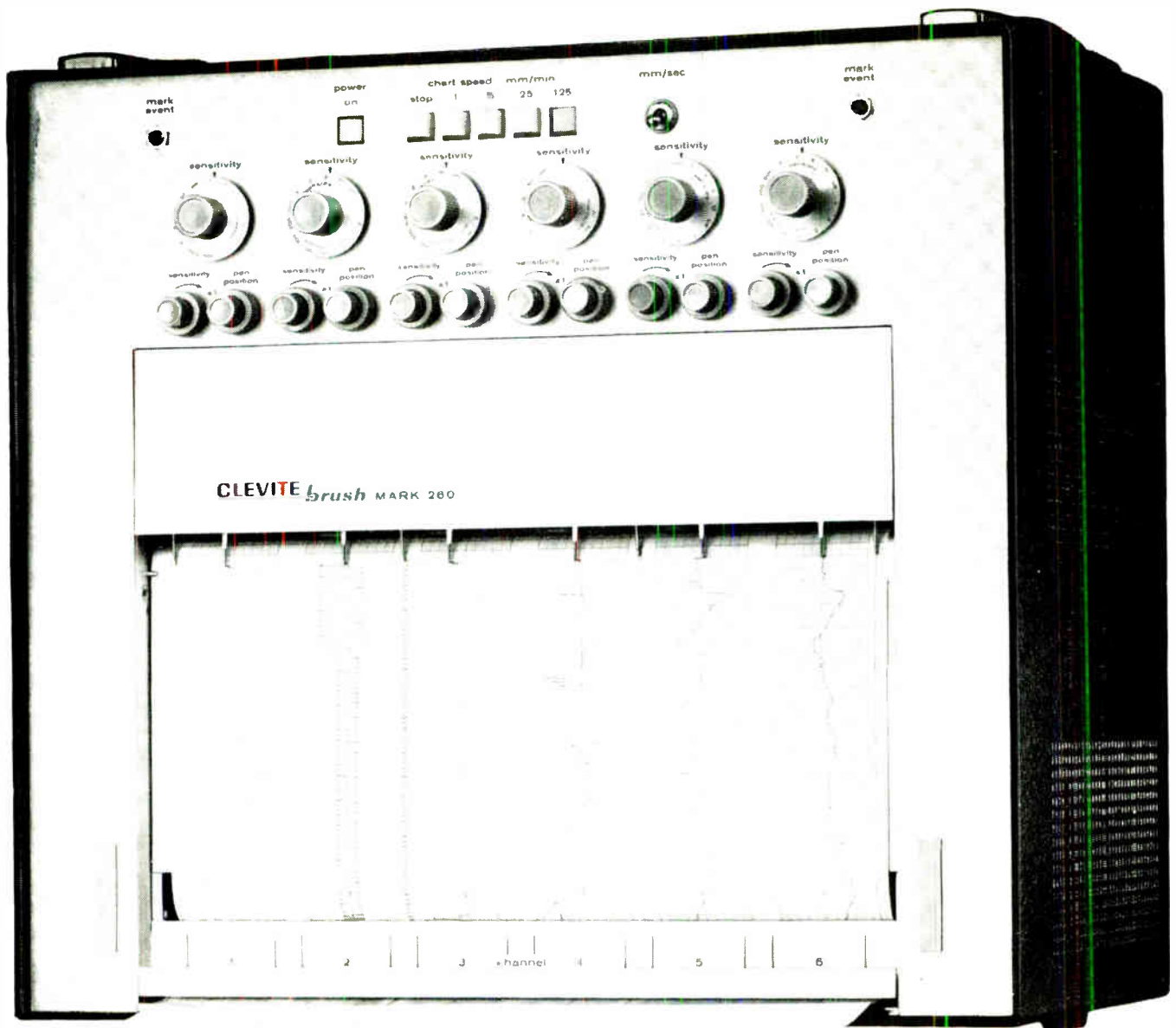

\$4500 is a lot of money for a portable multi-channel recorder. Or is it?

It depends on *what* portable recorder you're talking about. Take that new Mark 260 up there. It costs \$4500. But it's a bargain. It has six analog channels, and four event channels. (That's more than you get with recorders twice as big . . . and a lot more expensive). It has the famous Brush patented pressurized ink-writing system. (No spatter, no puddles . . . crisp clear smudge-proof traces at any writing speed) . . . rugged, reliable solid state electronics. (Bounce it around a bit. We don't mind, and it doesn't either) . . . 8 pushbutton chart speeds (easy as changing stations on your radio) . . . 99½% accuracy (which is as good as our best, the Mark 200. And that's a

good deal better than anything else on the market) . . . frequency response out to 150 Hz at usable amplitudes. Measurement range of 1 millivolt to 500 volts (covers anything you're likely to handle). ■ At \$4500 the new Mark 260 by Brush is the recorder bargain of the year. A full-color brochure is yours for the asking. Write: Clevite Corporation, Brush Instruments Division, 3773 Perkins, Cleveland, Ohio 44114.

CLEVITE BRUSH



A little light...

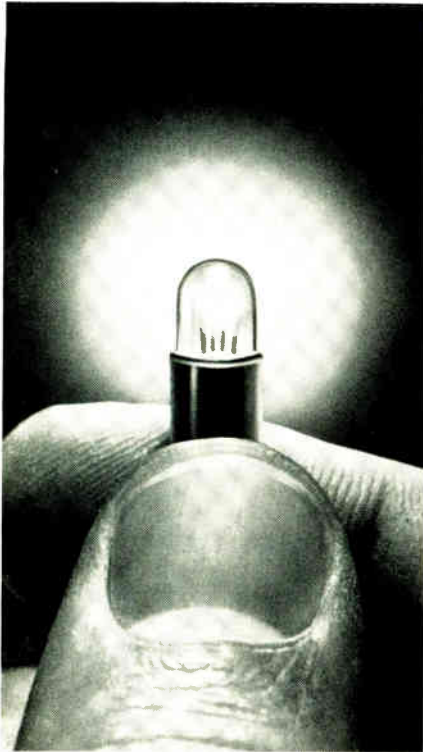

on subminiature lamp prices!

They're low, as low as 29 cents each. Yes, IEE really shines when it comes to providing quality subminiature lamps at 1/2 the price of competition.

The big features are inherent... hand placed filaments, seamless and tiplless envelopes, and each lamp is aged and selected. All this adds up to uniform brightness for over 100,000 hours.

Place a little IEE light on your lamp needs. You'll make lots of cents!



Industrial Electronic Engineers, Inc.
7720 Lebona Avenue, Van Nuys, California 91405

180 Circle 180 on reader service card

New subassemblies

It's what's inside that really counts

Engineers find a counter's circuit board blossoms as a separate counter

Like a chick that's emerged from its shell, a "baby" counter has popped out of Hewlett-Packard's new 5221A counter and is now being marketed on its own. Called the K01-5221A, the baby came about quite by accident.

At the IEEE show earlier this year in New York, the company's engineers took the 5221A apart to explain its operation. They took the circuit board that forms the heart of the counter, Nixie tubes and all, and set it to counting inside a big plastic sphere at Hewlett-Packard's booth. Much to their surprise, several systems people stopped by to ask if they could buy the board itself. The company got so many inquiries that it decided to market the board as a stripped-down counter. Unlike the 5221A, the offspring has no power supply, no input amplifier, no case, and no front-panel controls—it gets these from the system it's designed into.

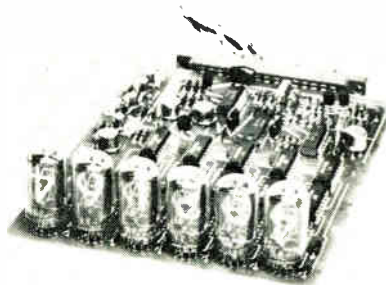

On its own. The counter, with no power source, amplifier or controls, is intended for design into new systems.

With suitable transducers, the counter board can sense and display weight, length, angle, pressure, flow rate, or any other parameter that can be converted to either pulse rate or time interval. Primary applications are in com-

NORTON

Magnetic Tape Heads

7528 1" Tape

7514 1/2" Tape

7507 1/4" Tape

SERIES 7500
Crosstalk—40 DB
+75°C Temperature Operation

Send now for complete technical literature.

NORTON

ASSOCIATES, INC.

10 Di Tomas Court, Copiague, N.Y. 11726
Phone: 516 598-1600

Circle 266 on reader service card

GRC[®]

die cast
ZINC ALLOY

molded
PLASTICS

Coil Bobbins
Gears & Pinions

GET THIS
SAMPLE KIT
GRC TINY
PLASTIC
MOLDINGS

Gries' special methods and Value Engineering combine to give you the highest functional value. We take the most imaginative engineering ideas and turn them into precise, uniform tiny parts. You save every step of the way... basic part thru final assembly.

NO SIZE TOO SMALL!
MAXIMUM SIZE FOR PLASTIC MOLDINGS: 1 3/4," .05 oz.

Write today on company letterhead for your kit.

GRIES REPRODUCER CO.

Division of Coats & Clark Inc. World's Foremost Producer of Small Die Castings
151 Beechwood Ave. New Rochelle, N.Y. (914) 633-8600

Circle 267 on reader service card



applications now being accepted for graduate engineers at all levels of experience in electrical, electronic and mechanical engineering, programming and other technical fields for design and development openings at the 200 billion electron volt accelerator to be located in the far western suburban area of Chicago, (Batavia) Illinois.

Applicants should write to Mr. Charles Marofski, Personnel Manager, at the address below, enclosing a biographical summary. **ALL REPLIES WILL BE KEPT CONFIDENTIAL.**



**NATIONAL
ACCELERATOR
LABORATORY**

1301 WEST 22ND STREET
OAK BROOK, ILLINOIS 60521

AN EQUAL OPPORTUNITY EMPLOYER

Very, very Varo.

(Very good. Very inexpensive.)

Each of these Varo epoxy bridge rectifiers has full-wave bridge, controlled avalanche, and 200V, 400V, and 600V ratings.

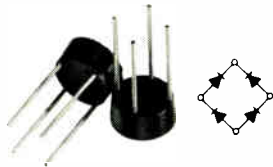

1 amp EBR. For printed circuit board mounting.

ONLY 91¢

in 200V rating and quantity of 1,000.

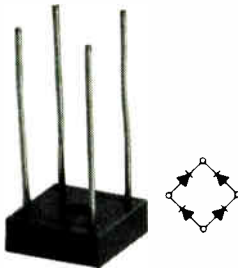

2 amp EBR. For circuit board mounting.

ONLY 95¢

in 200V rating and quantity of 1,000.

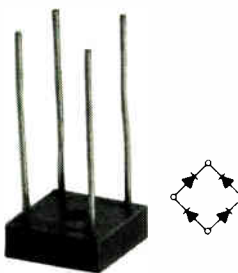

6 amp EBR. For chassis mounting.

ONLY \$1.59

in 200V rating and quantity of 1,000.

Write for complete information on Varo rectifier products.



VARO

SEMICONDUCTOR DIVISION
2203 WALNUT STREET, GARLAND, TEXAS 75040
(214) 272-3561

... a four-digit unit
costs \$300 ...

puters, data systems, and measuring instruments, according to Hewlett-Packard.

Rise and fall. The board counts at rates up to 10 megahertz and displays the result on Nixie tubes as a total or, when the count is gated, as a frequency. It can also measure time interval. It requires an input pulse amplitude between +3 and +5 volts, with a minimum pulse width of 40 nanoseconds and a maximum rise or fall time of 10 nsec. Accuracy is ± 1 count, \pm the accuracy of the power-line frequency, which is usually better than 0.1%.

When measuring time interval, the counter displays the number of clock pulses, derived from either a power line or an external oscillator, occurring during an event.

The sample display time can be varied from 50 milliseconds up to almost any period. Readout storage provides a continuous display of the most recent measurement. In the readout-storage mode, the display changes only when the new count differs. To simplify the readout, Hewlett-Packard uses a blanking circuit to suppress unwanted zeros to the left of the most significant digit.

For operation, the board requires a circuit power supply of 5.1 volts d-c, 750 milliamperes; a display power supply of 170 volts d-c, 1.5 ma for each Nixie tube, and a time reference of 9 volts rms at 60 hz. These inputs reach the board via a single circuit-board connector.

The counter board costs \$300 with a four-digit display; fifth and sixth digits are optional at \$50 each.

Hewlett-Packard is also offering another offspring of the 5221A. The KO4-5221A is an input amplifier board that can be used with the stripped-down counter. It permits operation of the counter without any reshaping of the input.

Priced at \$30, this amplifier accepts signals from 5 hz to 10 megahertz and has an input impedance of 1 megohm.

Hewlett-Packard Co., 1501 Page Mill Rd., Palo Alto, Calif. 94304 [391]

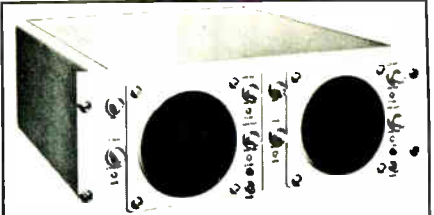

When your system requirements need continuous monitoring of multiple functions, include a BINARY ELECTRONICS X Y Monitor, Oscilloscope.

Each Monitor is an independent functional unit with modular construction, allowing versatile packaging.

The 5" flat-faced CRT has good deflection accuracy and DC to 1MHz frequency response.

Standard Bezel on a 7" front panel is compatible with most camera mounts and viewing hoods.

Circuits are time proven designs adopted to this Model from BINARY ELECTRONICS 5Mc-2P Dual Gun Oscilloscope.

Write for complete specifications.

We Are Authorized to Up Date
or Repair Your
PACKARD BELL
Model 5Mc-2P Scope



BINARY ELECTRONICS

of California

1429 STATE COLLEGE BLVD.

ANAHEIM, CALIF. 92806 714-772-3070

a division of

Avionic Structures, Inc.

Circle 268 on reader service card

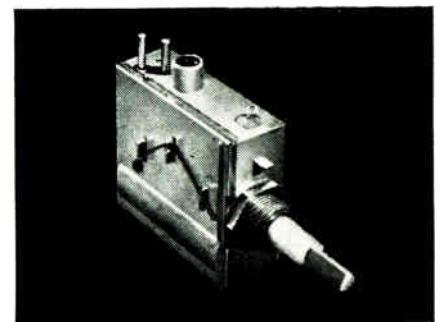

MITSUMI UHF TV TUNER

Far out rating the FCC and VDE specifications, which are widely prevailing in the World as telecommunication standards, the MITSUMI UHF tuner only radiates spurious signals less than 54 dB below the reference field strength. Material, plating, soldering, as well as the proprietary circuit design are the technical achievements by MITSUMI based on a long-term fundamental research.

Specifications	Model	UHF TV tuner UK-A32
Gain (dB)		-10 min.
Noise figure (dB)		14 max.
Image ratio (dB)		30 min.
IF rejection (dB)		60 min.
Frequency stability	Temperature Stability:	
	+300 kHz at 25-65°C -700 kHz at 25-65°C	
Outer dimensions (mm)	Voltage stability:	
	±100 kHz at 11V ± 1.1V	
		51 × 62.5 × 24.5



MITSUMI

MITSUMI ELECTRIC COMPANY LIMITED
1056 Koadachi, Komae-machi, Kitatama-gun, Tokyo. Tel: 489-5333
Marienstrasse 12, Dusseldorf, W. Germany. Tel: 352701
MITSUMI ELECTRONICS CORPORATION
11 Broadway, New York 4, N. Y. 10004. Tel: HA-5-3085

Rugged.

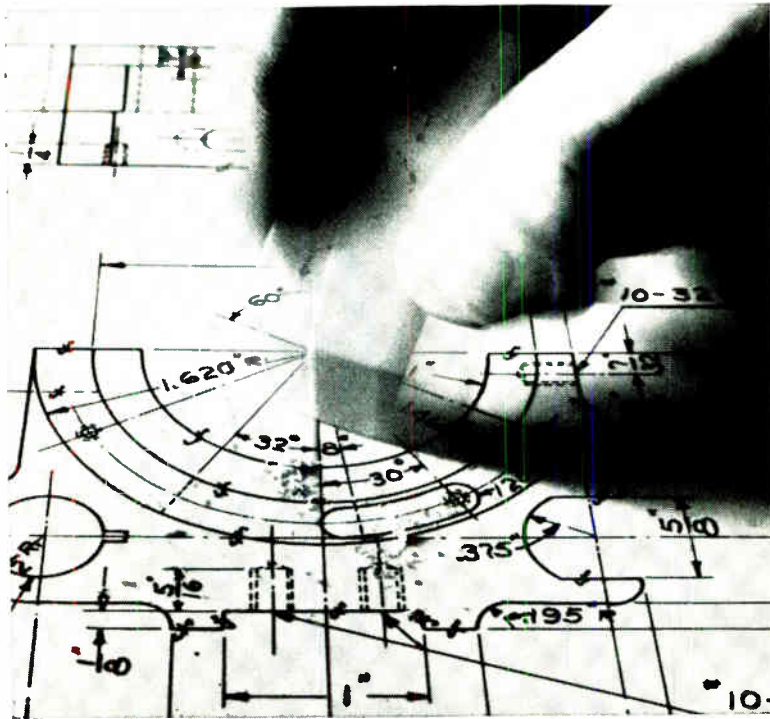

Kodak's ESTAR Base Films with new, tougher surface take more erasures.

As a matter of fact, your draftsmen can erase and draw in the same spot as many as 10 times . . . still have plenty of "tooth" for sharp pencil or ink lines. Because these films won't be "rubbed-out" before their usefulness is—you'll have fewer remakes. What's more, they process easier and faster than ever.

KODAGRAPH Wash-Off Films have been improved too. New drafting surface allows twice as many erasures as before.

Your Kodak Technical Sales Representative will be happy to show you how KODAGRAPH Products can help you to serve your draftsmen and engineering customers better and faster. And save you time, money—and monotony.

Write: Eastman Kodak Company,
Business Systems Markets
Division, Rochester, N.Y.
14650.

Kodak

DRAWING REPRODUCTION SYSTEMS BY KODAK

Centralab "Little Giant" Microglass Zener Regulators

Centralab's Little Giant zeners thrive in tight spots. Their performance and competitive pricing have opened new product miniaturization possibilities in entertainment, industrial and high reliability military and aerospace applications.

Our 400 mW regulator has a zener voltage breakdown of 6.8 through 200 volts; the 1 watt from 6.8 through 200 volts; and the 1.5 watt from 6.2 through 200 volts. So the Little Giants do a big job in cramped quarters. What else? They're tough. So tough that gruelling tests of acceleration, mechanical and thermal shock, vibration, lead and body strength, temperature, humidity, salt spray and altitude leave them unscathed. Centralab's Little Giant zeners.

Real crowd pleasers.

FOR MORE INFORMATION ON DIODES,
SOLAR CELLS AND READOUT DEVICES,
WRITE CENTRALAB TODAY. THESE
CENTRALAB PRODUCTS ARE MARKETED
DIRECT TO MANUFACTURERS AND THROUGH
CENTRALAB SEMICONDUCTOR DISTRIBUTORS;
INTERNATIONALLY THROUGH GLOBE-UNION
INC. — INTERNATIONAL DIVISION.

FIT IN ANY CROWD



CENTRALAB

Electronics Division
GLOBE-UNION INC.
5757 NORTH GREEN BAY AVENUE
MILWAUKEE, WISCONSIN 53201

M-6822

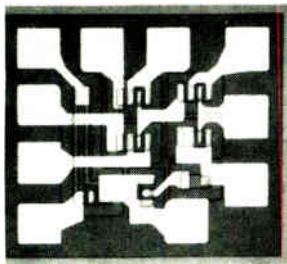

R-f/i-f amplifier LM171 is a versatile circuit that can be used in the emitter-coupled or cascode configuration from d-c to 250 Mhz. In the cascode configuration it provides 100 Mhz tuned power gain of 27.5 db. In the emitter-coupled configuration it provides 100 Mhz tuned power gain of 24.6 db. National Semiconductor Corp., 2950 San Ysidro Way, Santa Clara, Calif. [436]

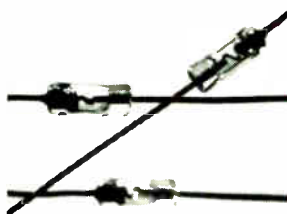

Epitaxial silicon tuning varactors series MA-45000 are 75 and 110 v units designed for large capacitance variation with bias. Typical performance is shown by the MA-45011, which has a typical r-f input power of 5.0 w, minimum breakdown voltage of 75 v, and a power dissipation of 350 mw. Units have wide applications for vhf-uhf. Microwave Associates Inc., Burlington, Mass. [440]



Measuring only 0.005 in. in diameter, the Micro-Bead thermistor is designed for measurement and control of temperature and of liquid or gas flow in any application where the mass of a larger element can not be tolerated. Response time is 0.12 sec in still air at 25°C. Dissipation constant is 0.04 mw/°C. Victory Engineering Corp., Springfield Ave., Springfield, N.J. [437]

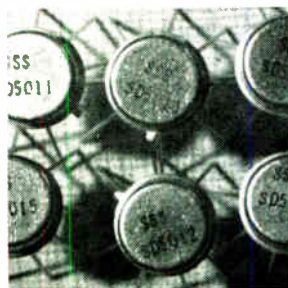

Three families of dual MOS transistors are offered with and without diode gate protection. Minimum source-drain breakdown voltage for the SD5014/15 is 120 v; for the SD5012/13, 65 v; for the SD5010/11, 30 v. Threshold voltages are typically 4 v; transconductance ratios, 0.8 to 1.0. Solid State Scientific Corp., Commerce Drive, Montgomery, Pa. 18936. [441]

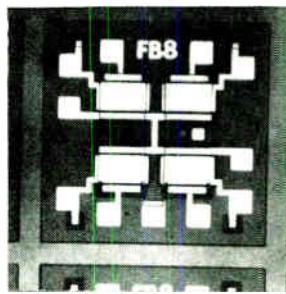

Monolithic MOSFET quad device HRM8052D is packaged in a 1/4 x 1/8 in. flatpack. Each of the FET's in the chip is a P-channel, enhancement mode, diode protected, insulated gate device optimized for multichannel commutation applications. Each device has a typical channel resistance of 300 ohms with a -10 v bias. Hughes Aircraft Co., Newport Beach, Calif. [438]

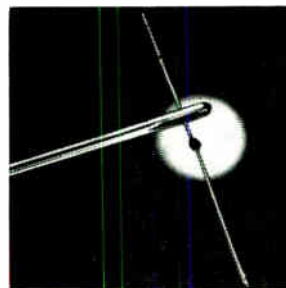

Microminiature forward regulator diodes, with from 1 to 6 individual junctions offer low voltage and low dynamic impedance. Four discrete voltage ranges are offered from 0.470 to 3.0 v, with or without controlled stored charge. Units may be operated with forward current from 0.1 to 10.0 ma. Reverse voltage at 10 µa is 10 v. Computer Diode Corp., Fair Lawn, N.J. [442]



Single-phase-bridge, silicon rectifiers model B172 offer reduced space requirements by handling maximum power per unit size. Units include double diffused, passivated junctions in a cold case design for high reliability. Current rating is 2 amps with free air mounting. Voltage ratings range from 50 to 1,200 v piv. Edal Industries Inc., East Haven, Conn. [439]

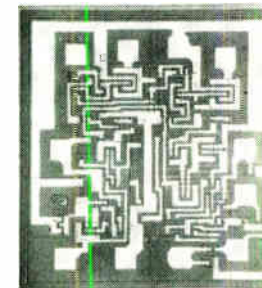

High-speed TTL one-shot circuit, or monostable multivibrator type TTL9601 features a retriggerable design. It provides a stable and accurate output pulse adjustable from 50 nsec to any width within the range of practical capacitor values. Input circuitry has a max. repetition rate greater than 10 Mhz. Fairchild Semiconductor, 313 Fairchild Dr., Mtn. View, Calif. [443]

New semiconductors

Three-stage comparator challenges 710

Engineer who designed both linear IC's says he's added current sink to older design to increase versatility

Ever since switching to the National Semiconductor Corp. a year ago, Robert J. Widlar has been trying to improve on the linear integrated circuits he designed at Fairchild Semiconductor, IC's that have become industry standards. National's LM101, for example,

was a modification—and direct market competitor—of Fairchild's 709 operational amplifier. In the same way, the latest from National, the LM106, is a three-stage, current-sinking version of the 710 voltage comparator.

"The biggest drawback of the

710 is that its output-current source supplies two milliamperes," Widlar says. "You have to sink a minimum of 1.6 mils even with only one transistor-transistor-logic output. The LM106's current-sinking output has a guaranteed worst-case fan-out of 10."

When the two-stage 710 was designed, Widlar explains, the objective was to make a simple circuit. Designing a current-sinking output would have required an extra stage and slowed the device.

Explanation. The LM106 has that third stage. By analyzing response times, Widlar found out what was slowing down the 710. First, he says, the input gain had to be

TAKE YOUR PICK!

Low Cost **NPN** and **PNP**
Low Level 'Diff. Amps'!

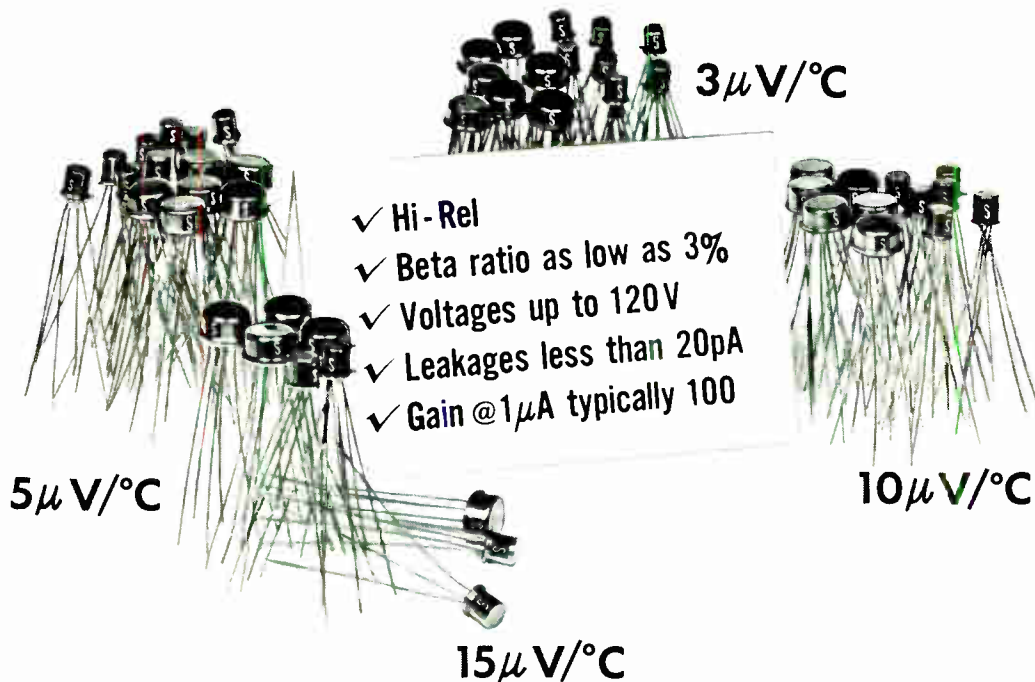

$3\mu\text{V}/^\circ\text{C}$

- ✓ Hi-Rel
- ✓ Beta ratio as low as 3%
- ✓ Voltages up to 120V
- ✓ Leakages less than 20pA
- ✓ Gain @ $1\mu\text{A}$ typically 100

$5\mu\text{V}/^\circ\text{C}$

$10\mu\text{V}/^\circ\text{C}$

$15\mu\text{V}/^\circ\text{C}$

In addition to offering one of the industry's widest lines of small signal transistors, Solitron will provide low cost differential amplifiers to meet your specific design requirements. Contact your local Solitron sales representative to obtain information for your circuit.

Or . . .

Dial 1-800-327-3243 for a "No Charge" telephone call and further information.

*When you think of semiconductors...
think Solitron!*

Solitron
DEVICES, INC.

1177 BLUE HERON BLVD. / RIVIERA BEACH, FLORIDA / (305) 848-4311 / TWX: (510) 952-6676



**Size 11
Resolver
State-of-
the-Art
is off
the shelf
at AEI**

Series 11RP Compensated Computing Resolvers are designed for a variety of Aerospace, Military and Aircraft applications where size, weight and accuracy are critical parameters. Exceptional output accuracy has been achieved by unique design of compensator coils to null out effects of temperature and other operating variables.

TYPICAL SPECIFICATION
Computing Applications

- Functional accuracy $\pm 0.1\%$
- Perpendicularity of axis $\pm 5'$
- Transformation ratio balance $\pm 0.1\%$
- Total null voltage 1MV/V

Data Transmission Applications

- Angular accuracy $\pm 3'$
- Total null voltage 1MV/V

Complete literature is available by writing Instruments Group, American Electronics, Inc., 1600 East Valencia Drive, Fullerton, Calif. 92634, (714) 871-3020, TWX 910-592-1256

**Instruments Group AEI
AMERICAN ELECTRONICS INC.**

Please rush checked item(s)

- 22-Page Resolver Design Manual
- New 4-Page Resolver Technical Catalog

NAME _____

TITLE _____

COMPANY _____

ADDRESS _____

CITY _____ STATE _____ ZIP _____

in lots up to 24 units, \$21.60 up to 99 units, and \$18 for over a 100. And from Fairchild comes word that it will have an improved version of the 710 on the market in the first quarter of next year.

National Semiconductor Corp., 2950 San Ysidro Way, Santa Clara, Calif. 95051 [444]

New semiconductors

**IC triggers
high-power devices**

Circuit that handles triac or SCR motor controllers is compact and inexpensive

Triacs and SCR's are great for controlling a-c induction motors, but they, in turn, are controlled by trigger circuits that are often complicated. A phase-control trigger circuit might incorporate a reference-voltage source, ramp generator, pedestal-level source, and differential comparator, for example. But a monolithic integrated circuit that handles all these functions and comes in a dual in-line package is now available from the General Electric Co. This IC, the PA436, along with the few external components it requires, can be mounted right on the motor housing. It's inexpensive, too—\$3.45 in quantities of 100 or more.

The PA436 converts an analog input signal into a phase-control pulse for triggering thyristors. The signal is compared with a reference and the proper trigger is obtained by the ramp-and-pedestal technique. In the case of a-c induction-motor speed control, the input signal comes from a tachometer on the motor. The device can be used to control temperature or light levels, too, in which case the control signal would come from a thermistor or a photocell.

The IC contains a zener diode for voltage regulation and a circuit for temperature compensation.

Semiconductor Products Dept., General Electric Co., Syracuse, N.Y. [445]



**MODEL 7400
V/F
CONVERTER**

Preserve your data integrity by converting quasi-static DC signals to frequency analogs prior to transmission with the New Rack Mounted version of the Ultra-Linear NUS "EFcon" Voltage to Frequency Converter Model 7400 . . . with practically NO DEGRADATION OF DATA.

- Linearity .003% • Stability .002% / °C
- Available in single unit bench mount or seven channel rack mount.

For further information and specifications, please contact:



NUS Corporation
Electronic Systems Division

9 Keystone Place Paramus, N. J. 07652
Phone: (201) 265-2400

Circle 270 on reader service card

**2 MODERN
BUILDINGS
FOR OFFICES,
LIGHT INDUSTRY
NEAR CAPE KENNEDY,
FLORIDA**

Prime 2-story bldgs. on Merritt Island, ideal for space-oriented firms. 4,653 sq. ft. Mila Office Bldg. available in 423 sq. ft. units. 56,400 sq. ft. Corps of Engineers Bldg. for industry and office use. 25,000 sq. ft. each floor. Minimum leasable area, 6,000 sq. ft. Alter to suit. Attractive rentals.



ESCO
Eastern Shopping Centers, Inc.

P.O. Box 3095G, Orlando, Fla. 32802

Circle 271 on reader service card

When your IC bugs out, chances are the heat's on!

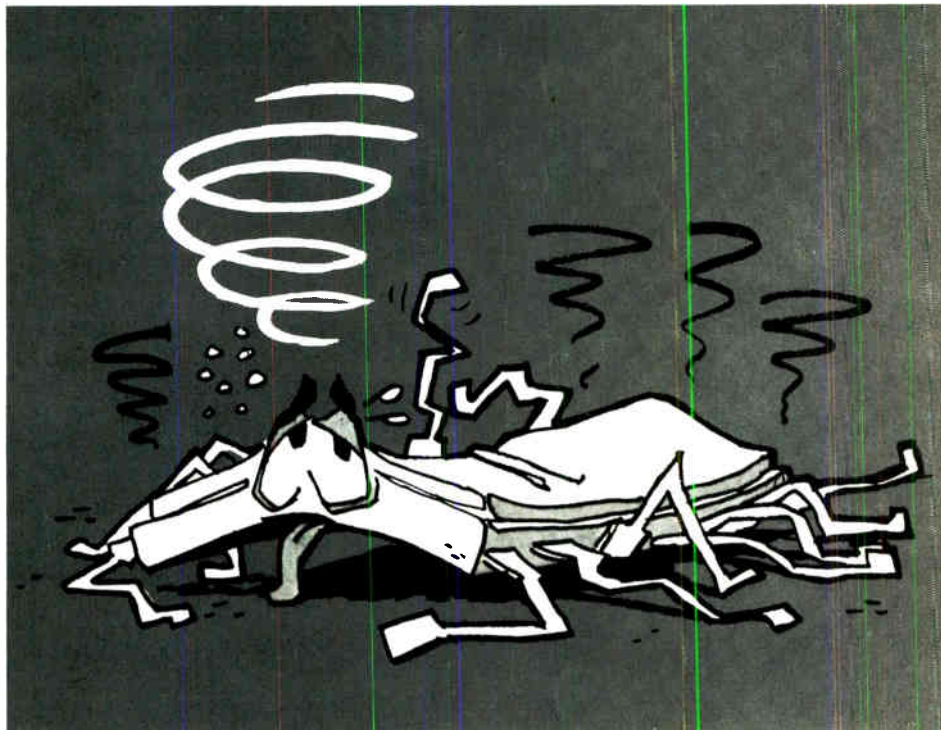
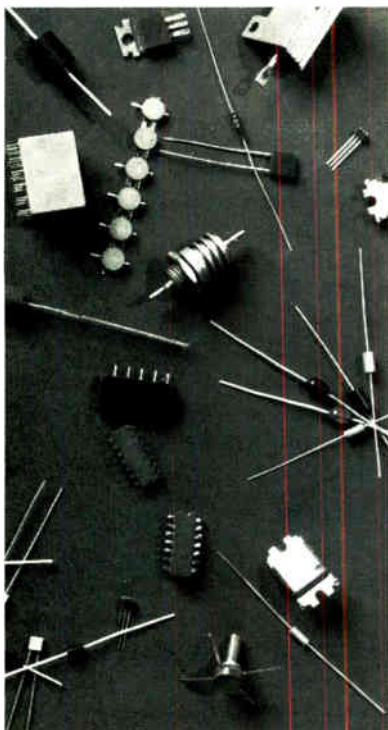

Devices packaged in Dow Corning® silicone molding compound are physically and electrically stable—even after long term exposure to both high heat and humidity. Derating, a practice common with organic packaging, is not necessary. In fact, you can design for high device and component density by using silicone molding compound. One manufacturer of glass package power diodes reduced the part to 1/30th of its former volume. Sizes from 1/5th to 1/3rd smaller can be obtained by using silicone molding compound in place of other plastics.

Little moisture absorption. Silicone molding compounds when exposed for 1000 hours to 93% RH at 70 C showed an average weight increase of 0.32% with the greatest increase being 0.5% and the least being 0.17%. Five organic plastics had average weight increases ranging from 1.0 to 2.1%—an average of nearly five times greater than silicone molding compounds under the same test conditions.

No cracking. Unlike other thermal setting plastics, Dow Corning silicone molding compounds are virtually unaffected by thermal shock. For example, a power resistor molded in Dow Corning® 307 compound was cycled repeatedly from -65 to 350 C without damaging the packaging material or the component.

Will not burn. Silicone molding compounds are

inherently nonburning. Thus, components and devices packaged in silicone molding compound do not constitute a fire hazard. No flame snuffers are used—a source of ionic contamination for devices packaged in organic materials.

Corrosion free. These silicone molding compounds are free of ionic contaminants which may contribute to metallic corrosion when operating in high humidity and influenced by voltage bias.

Competitive price. Costing only a fraction of a cent per device, Dow Corning silicone molding compounds enjoy a substantial price advantage over metal cans . . . glass packages.

Manufacturing economies. Transfer molding enables manufacturers to package devices and components with a minimum of manual labor and supervision. Good mold release and minimum flash assure high production rates . . . reduced deflashing costs. These manufacturing advantages make silicone molding compounds totally competitive with organic plastics.

So why be bugged by device failures because of a cheap plastic package? Specify Dow Corning® brand silicone molding compound, and get the best package protection in your electronic equipment . . . lets you keep your cool. For technical data, write: Dept. A-8472, Dow Corning Corporation, Midland, Michigan 48640.

DOW CORNING



di/dt capability 10 times industry's best EVEN WITH LOW POWER GATE DRIVE

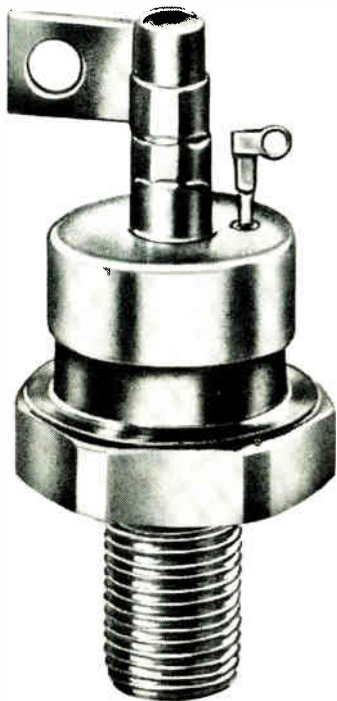

NATIONAL[®] INVENTS THE REGENERATIVE GATE* SCR

NATIONAL ELECTRONICS, INC. regenerative gate SCR is the only SCR that will give 600 amps/ μ sec. when tested according to JEDEC SUGGESTED STANDARD NO. 7 Section 5.1.2.4. This is a di/dt rating at three times the peak on-state current and $\frac{1}{2}$ the switching loss of any SCR now on the market. No sacrifice is required in gate drive, turn-on time, turn-off time or any other characteristic. Presently available in 55 amp and 110 amp SCRs.

NATIONAL[®] manufactures SCRs from 16 amp to 470 amp.

**Patent Pending*

REQUEST BULLETIN

NATIONAL
ELECTRONICS, INC.

a varian subsidiary

PHONE: (312) 232-4300 • GENEVA, ILLINOIS 60134

New Microwave Review



Ku-band tunnel diode amplifier model NC-12001 operates at 12 to 12.3 Ghz, with a noise figure of 6 db max. and intermodulation distortion in the third order not greater than -35 db relative to either of two signals at -50 db max. input. Input vswr is 1.20 and supply voltage is 18 v d-c. Micro State Electronics Operation, Raytheon Co., 152 Floral Ave., New Providence, N.J. [401]



Transistor amplifiers ranging from 1 Ghz to 1.8 Ghz deliver output powers of 1 to 3 w depending on center frequency and bandwidth. Typical model 1600-40-1.5-25D has a center frequency of 1.6 Ghz and a minimum 1 db bandwidth of 40 Mhz at a power output of 1.5 w with 25 db gain. Dimensions are 2 x 1 1/8 x 9 in. Microwave Power Devices Inc., Lynbrook, N.Y. [402]

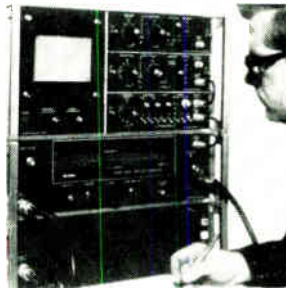

Calibrated spectrum analyzer model 2600 covers 10 Mhz to 90 Ghz. Using plug-in backward-wave oscillators, a sensitivity of -95 dbm can be maintained up to 10 Ghz by fundamental mixing and the instrument's standard 2 Ghz dispersion can be increased to an image-free 4 Ghz. Price is \$9,850. Polarad Electronic Instruments, 34-02 Queens Blvd., L.I.C., N.Y. 11101. [403]

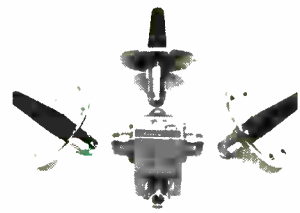

Airborne antenna array type 56360 may be mounted on missiles with diameters of less than 18 in. It consists of 3 low-silhouette monopole antennas and a 3-way power divider. It provides an omnidirectional pattern in the frequency band 1.435 to 1.540 Ghz, and operates at altitudes to 100,000 ft, and at air speed of Mach 2. Andrew Corp., 10500 W. 153rd St., Orland Park, Ill. [404]

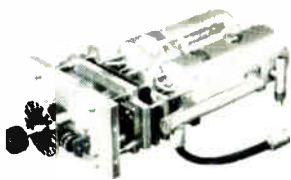

Master oscillator-power amplifier cascade subsystem 10078 is for drone control use. It consists of a pulsed master oscillator tetrode cavity, driving a Class C power amplifier tetrode cavity rated at 14 kw output. Operating range is 410 to 460 MHz. Duty cycle is 0.00015; output impedance, 50 ohms. Microwave Cavity Laboratories Inc., 10 N. Beach Ave., La-Grange, Ill. [405]



Five kilowatts of r-f power are dissipated in miniature Termaline load resistor model 8720. Designed for 1 1/8 in. EIA flanged line systems, the loads have a low vswr of 1.10 max. from d-c to 1 Ghz and 1.20 max. to 2 Ghz. Units are 8 in. long and weigh 2 lbs. Price is \$325 and delivery is 60 days. Bird Electronic Corp., 30303 Aurora Road, Cleveland 44139. [406]

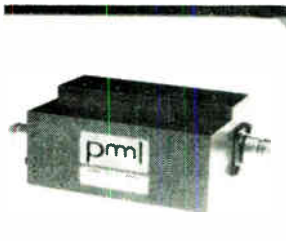

The 1,750-1,850 Mhz and 2,200-2,300 Mhz telemetry bands are efficiently diplexed using the F173A. Consisting of 2 bandpass filters, the unit is suited to both transmit-receive diplexing and signal separating or combing. Insertion loss in each band is under 0.35 db; isolation between bands, over 60 db. Peninsula Microwave Laboratories, 855 Maude Ave., Mtn. View, Calif. [407]

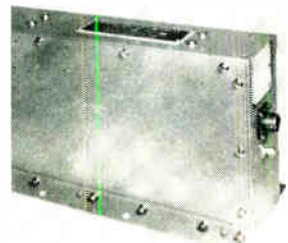

Amplifier-multiplier subsystem, packaged as a single unit features a bandwidth of 750 Mhz and operates over a temperature range from 0° to 70°C. It has a multiplication ratio of 36 to 1, requires no tuning, and operates with an output frequency of 8.375 to 9.125 Ghz from an input of 233.6 to 253.4 Mhz. Applied Research Inc., 76 S. Bayles Ave., Port Washington, N.Y. [408]

New microwave

Klystron is tunable automatically

Sliding contact in cavity permits precise tuning in seconds; 1,000 channel changes guaranteed

The trouble with klystrons is tuning. The usual inductive- and capacitive-tuning systems are subject to wear, arcing, and loss of vacuum. But Varian Associates has changed all this with a new version of their VA-884 klystron—the VA-884D.

Varian guarantees an operational life of 1,000 channel changes for its tunable klystron, but typical life expectancy is at least twice that. The tube is tuned by a sliding contact around a post in each cavity, rather than by the conventional bellows or diaphragm.

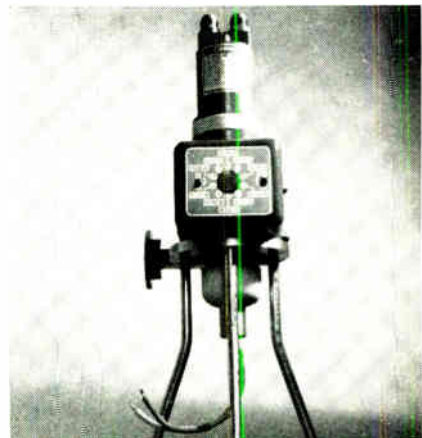

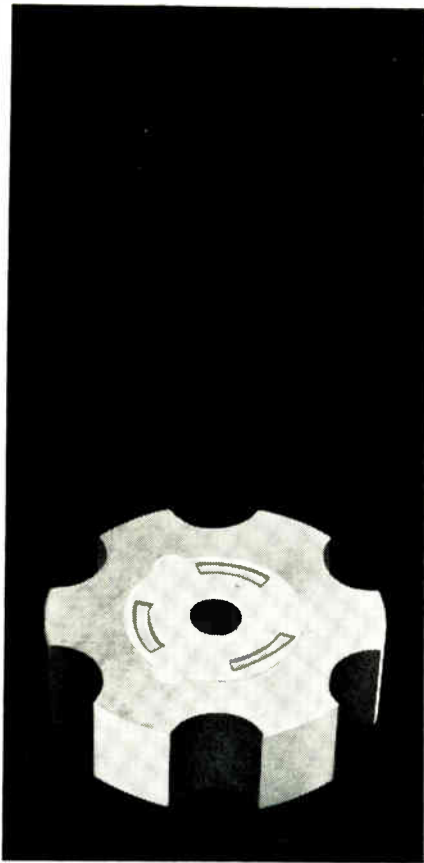

**For
Extra Meter
Precision
and Consistency
Specify
Hitachi Magnets**

To create these extremely stable magnets Hitachi developed its own processes for the compounding and heat-treatment of fine alloys. The result is a range of cast magnets for metering that are precisely finished to unusually close tolerances, are more compact, and yet retain magnetic stability and uniformity. You can get a fast supply of Hitachi meter magnets with properties to suit your particular application. Each one has guaranteed characteristics. Full information on types for your application can be quickly mailed.

Products:

Meter Magnets:

For Speedometer, Tachometer, Amperemeter

Motor Magnets:

For Micro Motor, Hysteresis Motor, Wiper Motor, Blower Motor

Generator Magnets:

For A.C. Generator, Flywheel



Head Office
Chiyoda Bldg., Marunouchi, Tokyo, Japan
Hitachi Metals America, Ltd.
Magnet Materials Sect.
437, Madison Ave., New York, N.Y. 10022,
U.S.A. Tel. 212-758-5255

**... channel changing is
fast and repeatable ...**

The klystron also contains a mechanism for automatically selecting any of 10 channels in the frequency range between 5.925 to 6.425 gigahertz. When the tube is retuned to a particular channel, the difference in bandpass characteristics isn't discernible, according to Varian. The output characteristic of each channel is flat, and the 1-decibel bandwidth at each preselected center frequency is between 60 and 70 megahertz.

Contact control. The channel-changing mechanism is an indexing head that positions a set of plungers, which, in turn, control the position of the sliding contact in each cavity. There are 10 positions for the indexing head, one for each channel. The mechanism can be operated remotely; the tube can be mounted in an antenna, for example, and operated from a control room.

The plunger system replaces the conventional screw adjustments and is much faster; typically, a channel change takes 4 seconds. The center frequency of each channel is set at the factory, but it can be changed simply by adjusting set screws in the indexing head.

Varian says the new klystron has the edge in applications in which relatively noisy traveling-wave tubes have been used for easy tuning.

The connectors at the klystron's input and output mate with UG-344/U waveguide flanges, and both liquid and forced air are used to cool the device. A 175-pound electromagnet is needed to focus, and the tube itself weighs 30 pounds.

The klystron's voltage standing wave ratio is typically 1.05, and the maximum is 1.5.

The 884D has a continuous-wave output of 5.3 to 17 kilowatts, depending on the beam voltage (12 to 19 kilovolts) and the r-f input (typically 80 milliwatts). Gain is at least 50 db, so a large r-f input isn't required. Efficiency is typically greater than 35%. The device is priced at \$10,000, with delivery in 30 to 60 days.

Varian Associates, 611 Hansen Way, Palo Alto, Calif. [409]

DIFFERENTIAL TRANSFORMERS

For measurement and control use

Capable of obtaining output voltages exactly proportional to any kind of mechanical variation.

Measuring value: 1/100,000~100mm
More than 300 types are available.



Features:

- *Outstanding interchangeability
- *Quite free from outer magnetic field
- *Insensitive to ordinary shock, water and heat

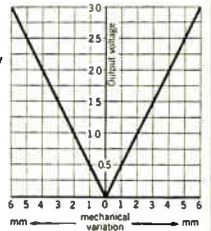

Manufacturers of Differential Transformers

NIPPON COIL CO., LTD.

Amakawa Bldg. 1, 1-chome, Hommachi, Higashi-ku, Osaka, Japan.

Circle 272 on reader service card

Cartoon by Whitney Darrow, Jr.

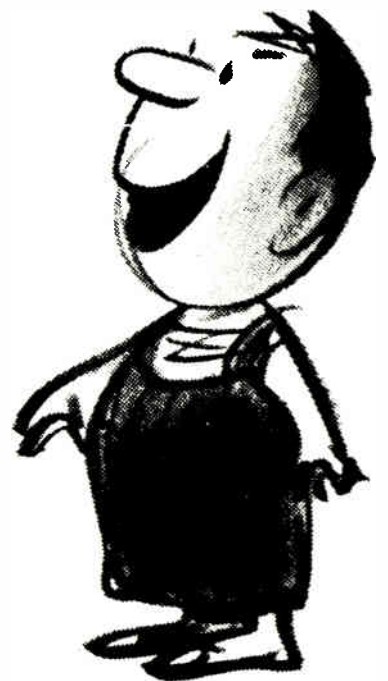

Be a buddy!

**One gift works many wonders
THE UNITED WAY**

The miniature relay with built-in arc suppression



Every time we add to the already enormous capabilities of Teledyne TO-5 Relays we surprise a lot of "relay skeptical" engineers.

Now *all* standard Teledyne Relays are available with internal diode chips for arc suppression. It is no longer necessary for you to add external diodes on your circuit board. Single

or double diodes (for polarity reversal protection), added to our many other performance assets, insures our undisputed leadership in the miniature relay field.

(We have also suppressed the price of the diodes!!! — \$1.00 or less).

Send for complete data:



TELEDYNE RELAYS A TELEDYNE COMPANY

3155 West El Segundo Boulevard • Hawthorne, California
90250 Telephone (213) 679-2205 • 772-4357

at
\$1.22*

*you have
no choice of
color...*

black



MODEL
3305P

also black



MODEL
3305W

... but they're Stocked In Depth by BOURNS Distributors!

the specs are better than "those other makes" that cost more! The Model 3305 TRIMPOT® potentiometer has been designed from the ground up as a commercial.

Here are the facts on the 3305 . . . besides the price, that is!

The unit is sealed to prevent contamination from fluxing, soldering, and cleaning . . . in addition our pins can be used on boards using 0.1" grid spacing. This small $\frac{5}{16}$ " dia. unit has a resistance range of 50Ω to $25K\Omega$, with standard resistance tolerance $\pm 5\%$. Being a wirewound unit, it provides plus features such as low temperature coefficient . . . better resistance tolerance . . . and superior noise characteristics. Operating range is -55°C to $+125^\circ\text{C}$. . . temperature coefficient is only ± 70 PPM/ $^\circ\text{C}$. . . power rating $\frac{1}{2}$ watt and noise is negligible at 100 ENR.

*500 piece price

Check into our one color—basic black—Model 3305 for the best . . . at a low-low price. For complete technical data contact your nearest Bourns office, representative, or stocking distributor.

FREE

Exploded-view drawing and
new informative specification
comparison chart



BOURNS, INC., TRIMPOT DIVISION • 1200 COLUMBIA AVE., RIVERSIDE, CALIF.
TELEPHONE (714) 684-1700 • TWX: 910 332-1252 • CABLE: BOURNSINC.

TRIMPOT® and Precision Potentiometers - Miniature Relays - Electronic Modules - Microcomponents.
Circle 194 on reader service card

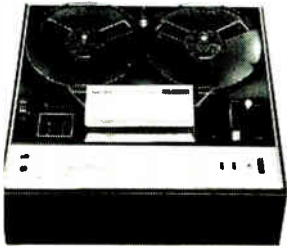

Stereo tape recorder has three heads for sound-on-sound and special-effects recording. Sony 355 operates at three speeds (7½, 3¾, 1⅞ ips), and has a 7-in.-reel capacity. Features include noise suppressor, tape-source monitor, scrape-flutter filter. The unit retails for less than \$229.50. Superscope Inc., 8150 Vineland Ave., Sun Valley, Calif. 91352. [421]



Two-way, transistorized f-m base-station radio for the 450-Mhz band has IC-oscillator module to provide 0.0002% stability. Line includes mobile units. Silicon transistors are used throughout both base stations and mobiles, including power output stages. Multichannel capability is available. General Electric Communication Products Dept., P.O. Box 4197, Lynchburg, Va. [422]

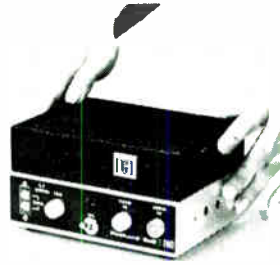

R-f modulator with separate audio and video attenuation permits variation of input levels. Two r-f carriers transmit picture and sound on the same tv channel to one or more receivers in closed-circuit system. Model MPS-15 (channels 2 through 6), \$150. Model MPS-16 (channels 7 through 13), \$160. Packard Bell, Box 337, Newbury Park, Calif. [423]



R-f programing switch has six normally-open contacts that can be arranged in any combination of fan-in and fan-out groups. Maximum crosstalk is 80 db; insertion loss, 0.4 db. Up to 270 Mhz minimum isolation is 60 db and maximum vswr is 1.09; up to 500 Mhz, minimum isolation is 45 db and maximum vswr is 1.30. Seallectro Corp., 225 Hoyt St., Marmonneck, N.Y. 10543 [424]



Battery-operated, 50,000 ohms-per-volt multitester measures resistance in four ranges up to 10 megohms. Meter has 5¼ in. face, spring-backed jewels and self-shielded movement. It's useable at frequencies up to 100 khz, has built-in overload protection. Price is \$19.95. Lafayette Radio Electronics Corp., 111 Jericho Turnpike, Syosset, N.Y. 11791 [425]

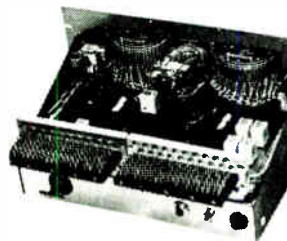

Paging terminal with automatic memory bank uses only groups of 100-number assignments. Capacity range varies from 50 to 2,500 calls in blocks of 50-code groups. Output interconnections can be line-per-terminal, level, or leased line. The system operates with all-PBX boards. Prices are quoted per application. Richmond Radiotelephone, P.O. Box 565, Richmond, Ind. 47374 [426]



Portable a-m/f-m radio and cassette recorder operates on batteries or standard a-c. Output is 0.8 watt; signal-to-noise ratio, 43 db; frequency response, 100-9,000 hz, ±6 db. Recorder has two tracks. Speed is 1⅞ ips. Dimensions are 10 x 7½ x 2½ in. Price is \$99.95. Bell & Howell, Photo Products Group, 7100 McCormick Rd., Chicago, Ill. 60645 [427]



Ten-watt portable single-sideband radiotelephone and radiotelegraph unit operates up to two independent and two dependent channels in the 1.6 to 15 Mhz range. It can be powered by "D" batteries, alkaline cells, or nickel-cadmium batteries which may be recharged from a 12-volt auto electrical system. Kaar Electronics Corp., 1203 W. St. Georges Ave., Linden, N.J. 07036 [428]

New consumer electronics

Color tv camera focuses on low cost

Broadcast-quality unit costs \$18,500; setup time is short since mirrors, three vidicons are permanently positioned

The success of the International Video Corp.'s low-priced (under \$13,000) color television camera [Electronics, Nov. 13, 1967, p. 238] will be dwarfed by that of its Model 100, priced at \$18,500, says Louis Pourciau, the company's engineering manager. Thus far, he

says, IVC has delivered more than a hundred of the new cameras and has "large quantities" backlogged to the Bell & Howell Co., which agreed to purchase \$10 million worth of cameras and related equipment in April.

When the newly formed com-

pany introduced its first camera it emphasized that though the picture quality was good, the camera did not meet broadcast-quality standards. Nonetheless, the low-cost—one-seventh that of comparable cameras—and picture quality made the camera a success in closed-circuit tv operations.

The new model is aimed at another market—television stations. It produces a standard NTSC color signal and fulfills the FCC requirements for color broadcasting. The price includes the external color encoder, cable, studio junction box, remote control and 6:1 zoom lens. For most stations that are already in the color broadcast

We're Turning The Pot Industry On Its Ear!

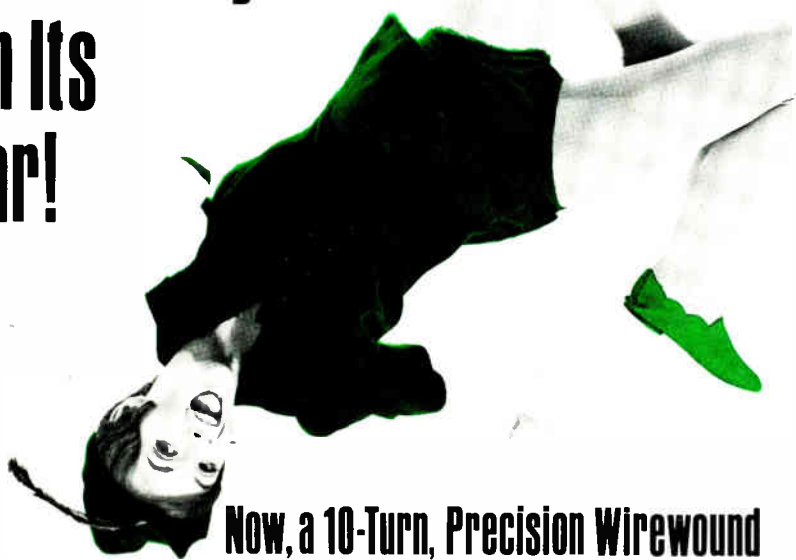

Now, a 10-Turn, Precision Wirewound

"PIXIEPOT"

T.M. (PAT. PEND.)

FOR AS LOW AS

\$3.97 EACH

That's right! The Duncan Model 3253 "PIXIEPOT" potentiometer is yours for as low as \$3.97 each in production quantities and only \$5.95 each for 1-24 units. Match the following "PIXIEPOT" features with any other similar pot on the market.

- Length: ONLY 3/4"
- Diameter: ONLY 7/8"
- Linearity: ±0.25%
- Resistance Range: 100 ohms to 100K ohms
- Power Rating: 2 watts @ +20°C
- Temperature Range: -25°C to +85°C
- Resolution: Better than ANY wirewound pot TWICE its size!
- Slotted Stainless Steel Shaft

A Duncan "PIXIEPOT" can save you dollars on your instrument and system requirements. If you want to know just how many, call or write us today. The full story on the "PIXIEPOT" will be in the mail to you within 24 hours.



DUNCAN electronics, inc.

A DIVISION OF SYSTRON-DONNER CORPORATION
2865 FAIRVIEW ROAD, COSTA MESA, CALIFORNIA 92626
Phone: (714) 545-8261

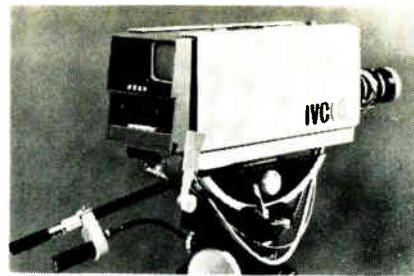

business, no additional equipment is necessary. For stations just getting into color work, a \$1,600 EIA color sync generator is required. But even with the cost of the sync generator included, the Model 100 makes color tv available to many stations that have been forced to squeeze black-and-white commercials between network color shows. The camera will also make color shows of local origin available in areas where revenues could not support an \$80,000 investment for color equipment.

Simplicity. The camera's success, says Pourciau, can be attributed to its extremely accurate colorimetry, even though the camera uses vidicon rather than the more expensive Plumbicon tubes. Most of the credit, he says, goes to the simplified system of plate beam-splitters. From relay lenses that shorten the back-plane focal length of the taking lens, light passes through a series of computer designed dichroic (semitransparent, selectively transmissive) mirrors which split the light into the three primary colors and direct them to the vidicon tubes. The optics are so good, says Pourciau, that high quality pictures can be obtained with illumination levels as low as 300 foot-candles.

Also, says Pourciau, most of the usual mechanical adjustments have been eliminated through use of an elaborate tool-and-jig system employed during manufacture. All mirror positions and vidicon lateral and vertical positions are fixed and need never be changed. The IVC 100 has a maximum of 28 internal setup adjustments, far fewer than any professional-quality color television camera. Operation, setup, and maintenance are simplified and approach that of a monochrome camera, Pourciau adds.

International Video Corp., 67 East Evelyn Avenue, Mountain View, Calif. [429]

business trips rule out evening classes?



here's a practical way to update your knowl- edge of electronics

Are irregular hours, travel and family obligations keeping you from attending classes—even though you worry about becoming technically obsolete? Check into the Special Programs in Electronics for Engineers developed by CREI, the Home Study Division of the McGraw-Hill Book Company.

These are not simply courses, but comprehensive programs in advanced electronics offering major electives in such fields as

Communications Engineering, Aeronautical and Navigational, Television Engineering, Automatic Control Engineering, Missile and Spacecraft Guidance, Radar and Sonar Engineering, Nuclear Instrumentation and Control, Computers.

Industry-recognized CREI Programs make it possible for you to catch up on new developments in electronics through study in your own home, at your own pace,

your own schedule. Free book gives complete information and details of technical material covered. For your copy, mail coupon below or write: CREI, Home Study Division, McGraw-Hill Book Company, Dept. 1828-G, 3224 Sixteenth St., N.W., Washington, D.C. 20010.

Founded 1927



Accredited Member of the National Home Study Council



CREI, Home Study Division, McGraw-Hill Book Company
Dept. 1828-G, 3224 Sixteenth St., N.W.
Washington, D.C. 20010

Send me free brochure describing CREI Programs in Electronics for Engineers.

NAME _____ AGE _____

ADDRESS _____

CITY _____ STATE _____ ZIP CODE _____

COMPANY _____

TITLE _____

LMI

Shielded rooms won't let obsolescence box you in

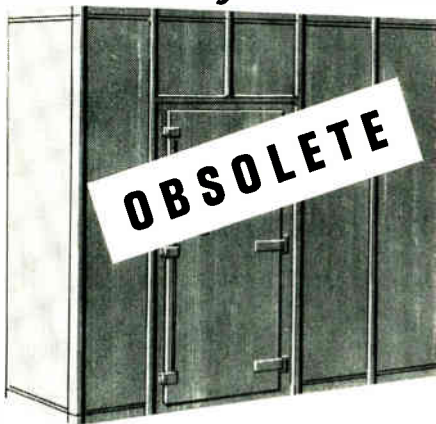

Design • Changes in Government and Industry RF shielding specifications can quickly obsolete costly shielded rooms. That's why LMI RF shielded rooms are designed with built-in capability for upgrading. Any of the seven standard rooms designed and manufactured by LMI can be upgraded with appreciable savings over the cost of a new room. LMI designs utilize solid membrane, clamp-together or all-MIG-welded seams and provide maximum shielding over the widest frequency range.

Upgrade • For example, Class D Rooms can be upgraded by MIG welding all seams and/or adding an additional shield.

All-welded Class C and higher rooms can be upgraded by the addition of an inner shield, acoustic and microwave anechoic material at any future date.

Class AA and AAA are all-welded dual wall, solid shielded rooms for the highest performance from low audio to highest microwave frequencies.

Cost • The initial low cost and final costs are one and the same with LMI all-seams-welded rooms. There is no seam leakage nor any maintenance requirements over the life of the shielded room.

Technical Bulletin • For a complete description on all classes of LMI shielded rooms, write for your complimentary copy of Technical Bulletin (TB-101) "Technical Discussion and Specifications for Electromagnetic Shielded Rooms."

Quick Reaction • For fast personal service on your shielding problems telephone or write direct to Fred J. Nichols, Carl T. Luce or James C. Senn.

LectroShield Division
LectroMagnetics, Inc.

6056 West Jefferson Boulevard
 Los Angeles, California 90016
 Area Code 213 870-9383

198 Circle 198 on reader service card

New Books

Betwixt and between

Radiation Effects in Semiconductor Devices
 Frank Larin
 John Wiley & Sons Inc.
 287 pp., \$11.95

All writers direct their product at a certain audience, and all must decide fairly early in the creative process just what kind of group they want to address. For writers of books aimed at engineers, the decision can be especially difficult. How much material in a book on a specialized field of interest should be devoted to educating nonspecialists? Too much background information will try the patience of the specialist; too little will strain the understanding of the outsider.

Larin, like many others, hasn't been able to resolve the dilemma. Apparently assuming that the reader needs a good refresher course in semiconductors, he provides a detailed coverage of them in chapters 2 through 7. This abundance of tutorial information means that the subject of radiation and its effects isn't discussed as fully as it might be; for example, there are aspects of radiation hardening, such as testing, that the author hasn't explained in detail. On the other hand, however, an engineer with little or no familiarity with semiconductors will probably need even more instruction than the book offers to attain the necessary level of understanding.

The book has very little to offer to an engineer already working in the field of radiation hardening. However, the radiation-effects engineer will probably find chapter 12 of great interest, because it is here that Larin discusses the process of obtaining data on the physical semiconductor parameters required for analysis of the effects of radiation. This has been one of the most frustrating aspects of such analysis, and the lack of this kind of information has led many investigators to develop empirical relations involving only electrical parameters.

As an introduction to the techniques of hardening semiconductor circuits, however, the book should find a widespread welcome. It provides a good foundation of knowl-

edge on the effects of neutrons, gammas, and charged particles on semiconductor devices. The text could be a very good candidate for use in courses on the state of the art.

Larin is obviously quite expert, and his discussion is relatively thorough from the analytical point of view. This is not to say that the book is free from minor problems of exactitude; for example, the author's assertion in the preface that the equations allow "precise" calculations of the effects of radiations is not necessarily true, even if one knows the "hard-to-find" physical parameters for each and every semiconductor device in the circuit. But even though these equations do lack some precision, they can provide meaningful relative predictions.

Joseph T. Finnell Jr.

Avco Corp.
 Wilmington, Mass.

Thoroughly modern

Elements of Control Systems Analysis
 Chih-fan Chen and I. John Haas
 Prentice-Hall Inc.
 471 pp., \$13.50

Traditionally, control engineers have tackled design problems by taking an electrically oriented approach based on the complex function theory of mathematics. They measure variables, convert data for analysis, describe a system analytically or from a model, determine response, perform qualitative analysis, and finally modify an existing system or develop a new one. Recently, an alternate, mechanically oriented technique, based on state-variable theory and called the modern approach, has been developed.

This text clearly and comprehensively covers this newer approach, and, fortunately, pays equal attention to the older conventional approach. The authors know that effective engineering demands versatility and thus believe that two approaches to any complex problem are better than one.

They're to be commended for their liberal use of design examples to illustrate complex points. And just as welcome is the transla-

Instant photometric measurement...

of cw and pulsed light with the direct-reading EG&G LumenMeter

The new EG&G Model 565 LumenMeter lets you measure both cw and pulsed light events (as fast as 10 nsec.) directly. It offers absolute accuracy of $\pm 6\%$; repeatability of $\pm 1\%$. An easy-to-see, direct-reading meter provides a dynamic measurement range of 0.1 to 1000 lumen/ft.² for average power or 0.1 to 1000 lumen-sec./ft.² for integrated energy. System response of the Model 565 closely conforms to the CIE luminosity curve.

To assure accuracy, the Model 565 LumenMeter is calibrated against both a tungsten standard ($\approx 2870^\circ\text{K}$.) and a

Xenon lamp standard ($\approx 6000^\circ\text{K}$.) with traceability to the N.E.S. In addition the 565 features: four decade range selection with a scale expander for low scale readings

- compensation circuit to balance out spurious background light
- flat, well defined 8° solid angle field
- provision for synchronous triggering of pulsed light sources.

The new, EG&G LumenMeter is a completely self-contained, lightweight, portable instrument selling for only \$1375. It's suitable for both laboratory and field work. It is small enough to be hand-held, or it can be tripod mounted.

The Model 565 is battery-powered using standard "D" cells. An optional leather carrying case with neck strap is available to protect your LumenMeter when not in use.

If you'd like more information on the first, really new photometric measuring instrument, EG&G's LumenMeter, or for that matter on any of our products such as photodiodes, light instrumentation, flashtubes, thyatrons, krytrons, spark gaps, transformers, or picoammeters, write: EG&G, Inc., 166 Brookline Avenue, Boston, Massachusetts 02215. Tel.: 617-267-9700. TWX: 617-262-9317.



NEW THERMOCOUPLE REFERENCES WITH 25 CHANNELS ONLY \$259.00!

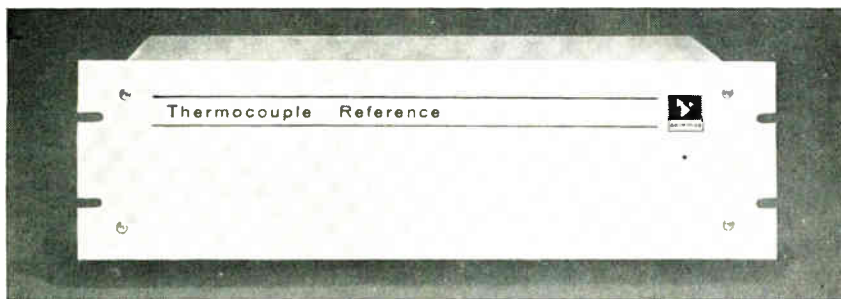

Now — ACROMAG Series 330 Thermocouple References with 25 channels of 0°C ice-point compensation for only \$259.00, including ALL 25 thermocouples! Uniformity 0.05°C, one-second warmup, easy to use. Ideal for scanned TC systems, DDC, and laboratory use. Series 340 References (150°F oven-type) with 25 channels for \$289.00! Series 320 Single-Channel 0°C References, AC powered, for only \$75.00! Stocked in ISA Types, J, K, T, R & S. Others to order!

Request Technical Data 32

ACROMAG
INCORPORATED

30765 Wixom Road • Wixom, Michigan 48096
Phone (313) 624-1541

Makers of Precision Instrumentation and Controls



Circle 273 on reader service card

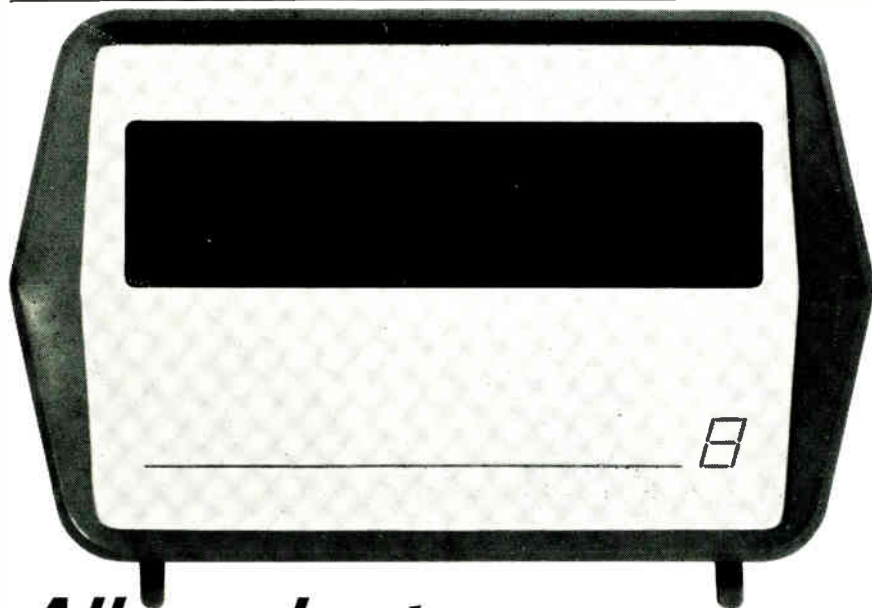

All readouts look the same

Whether it's the well-known tube, one of several rear projection systems, EL, or even Dialight's in-plane seven-segment readout, you can't tell the difference when it's off. There's one way you can really see the difference. Send us the coupon on the adjacent page and borrow a Dialight demonstrator unit.

DIALIGHT

DT-122

New Books

tion of several systems analysis problems into computer language.

In their discussion of the conventional approach, the authors concentrate on high-order differential equations to describe a system, poles-zeros to analyze it, frequency measurements to identify it, trial and error to design it, and indirect approaches to optimize it. They rely mainly on the Laplace transform and on the analog computer. The first few chapters cover in detail several points usually ignored in modern texts, such as Lagrange's formula.

The second half of the book, describing the modern approach, confines itself to analysis. It covers the set of first-order differential equations used to describe systems, linear transformations for analysis, Liapunov theory for studying system stability, time-domain analysis for identification, and the direct approach for optimizing. Here, the main mathematical tool is matrix theory, the main physical one the digital computer.

Not much light

Optical Lasers in Electronics
Earl L. Steele
John Wiley & Sons
267 pp., \$11.95

Don't be misled by the title—the scope of this book isn't as broad as all that. Optically pumped and semiconductor lasers are discussed as they're used in industry, but not gas lasers. The book should interest those looking for a good review of such laser devices as oscillators and amplifiers, but it will disappoint those expecting a sophisticated and complete account of laser physics.

There's no reason to insist on equal time for gas lasers, but the single sentence in the preface, "The gas laser is not treated," is short shrift indeed. And something important is lost by avoiding quantum mechanics in the chapter on laser radiation physics.

Unfortunately, some of the terms used are confusing. For example, the pump chamber (the container used to concentrate pump light into the laser rod) is defined as the laser

cavity—a technical malapropism started by pioneers in optically pumped lasers. The term “laser cavity” ought to be reserved for the resonant cavity formed by mirrors at the ends of the amplifying medium.

Even the term “optical lasers” is confusing—primarily because it is redundant. The author would have done better to call the devices optical masers or just lasers.

Another error is a common one: E.I. Gordon is incorrectly listed in a reference to an article called “The Laser”; the author is actually J.P. Gordon. Both are active in the field.

On the positive side, the author does a creditable job in his discussion of semiconductor lasers. The language, for the most part, is straightforward, and many diagrams, illustrations, and graphs complement the text. The glossary defines all the symbols that appear, chapter by chapter.

Charles B. Zarowin
International Business Machines Corp.
Yorktown Heights, N.Y.

Our little black book has over 100,000 phone numbers.

You never had a black book like it. Over 1,500 pages. And those phone numbers! More than 100,000 telling you who to call/where to go, for the over 4,000 different product categories listed and advertised in the yellow pages of the **Electronics Buyers' Guide**.

It's the industry's one-stop shopping center that lets you find the products and services you need quickly. You can depend on EBG.



Electronics Buyers' Guide

A McGraw-Hill Market Directed Publication,
330 West 42nd Street, New York, N.Y. 10036

DIALIGHT CORPORATION
60 Stewart Ave., Brooklyn, N.Y. 11237

Yes, I'd like to borrow a demonstrator unit. Have your representative call. No obligation.

My readout application is _____

Name _____ Title _____

Dept. _____ Phone _____

Company _____

Address _____

City _____ State _____ Zip _____

Recently published

Sophisticated Signals and the Uncertainty Principle in Radar, D.E. Vakman, Springer-Verlag New York Inc., 253 pp., \$14.80.

Translated from Russian, this book discusses the theory of signals whose time-spectrum product substantially exceeds unity and how they make it possible to improve the resolution of targets, simultaneously measure range and range rate, and electrically scan over finite angular dimensions.

Electro-Optical Photography at Low Illumination Levels, Harold V. Soule, John Wiley & Sons, Inc., 392 pp., \$15.95.

Tells the reader how to handle problems with low light level systems. Details the physical characteristics of both vacuum tube and solid state image intensifiers, image-intensifier camera and high-speed television line-scan recording techniques, neutron and X radiation conversion techniques and applications through near infrared, and natural night radiation sources.

Applied Optics: A Guide to Modern Optical System Design, Leo Levi, John Wiley & Sons, Inc., 620 pp., \$18.95.

Covers analysis and design of optical components and systems. Includes sections on incandescent, discharge, luminescent, laser light sources, and light modifiers—including mirrors, prisms, and lenses. Emphasizes optics for communications.

Earth's Particles and Fields, Billy M. McCormac, Reinhold Book Corp., 464 pp., \$27.50

Edited proceedings of a 1967 NATO Advanced Study Institute meeting covers both high- and low-energy charged particles, diffusion, acceleration and loss of charged particles, electric and magnetic fields and wave-particle interactions, and solar wind-magnetosphere interactions. A reference source for such applications as satellite measurement and space environment, communications, and detection of nuclear tests in space.

DIALIGHT



...until they're turned on.

What a difference! Try walking back 10 feet, 20 feet . . . even 30 feet. No trouble with the sharp, bright, 1-inch high numerals of Dialight readouts even from extreme angles. Modules as low as \$3.99 less lamps in 1000 lot quantities. Send coupon to borrow demonstrator unit shown here and see for yourself.

DIALIGHT

DT-123

The Complete Line of Fuseholders For All Applications

Panel mounted, in-the-line, lamp indication, signal-activating, visual indicating . . . with solder terminals, quick connect terminals. Also holders to meet Military Specifications under MIL-F-19207B.

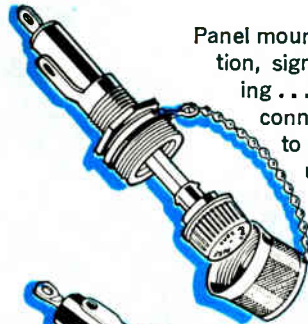

HMR RF shielded holder for 1/4 x 1 1/4 in. fuses.



HPC Panel mounted holder for 13/32 x 1 1/2 in. fuses. Rated 30 amperes for any voltage up to 600.



HKP panel mounted holder for 1/4 x 1 1/4 in. fuses.



HKA lamp-indicating, signal activating holder.

Write for BUSS Form SFB

INSIST ON
BUSS QUALITY
FUSES

BUSSMANN MFG. DIVISION, McGraw-Edison Co. St. Louis, Mo. 63107

Circle 202 on reader service card

The Complete Line of Signal-Indicating Alarm-Activating Fuses

For use on computers, microwave units, communication equipment, all electronic circuitry.



BUSS GLD-1/4 x 1 1/4 in. Visual-Indicating, Alarm-Activating.



BUSS Grasshopper Fuse, Visual-Indicating, Alarm-Activating.

BUSS GBA-1/4 x 1 1/4 in. Visual-Indicating.



BUSS MIC-13/32 x 1 1/2 in. Visual-Indicating, Alarm-Activating.



BUSS ACH Aircraft Limiter, Visual-Indicating.

BUSS MIN-13/32 x 1 1/2 in. Visual-Indicating.



FNA FUSETRON Fuse 13/32 x 1 1/2 in. slow-blowing, Visual-Indicating, Alarm-Activating. (Also useful for small motors, solenoids, transformers in machine tool industry.)

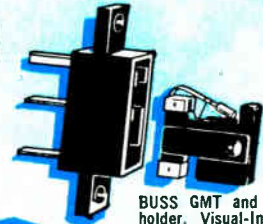

BUSS GMT and HLT holder, Visual-Indicating, Alarm-Activating.

Write for BUSS Form SFB

INSIST ON
BUSS QUALITY
FUSES

BUSSMANN MFG. DIVISION, McGraw-Edison Co. St. Louis, Mo. 63107

Circle 202 on reader service card

BUSS: The Complete Line of Fuses and . . .

SPECIAL COSMICAR[®] LENSES

COSMICAR lenses have improved in quality as CCTV cameras have improved.

There is no problem whether your cameras are with a built-in EE mechanism or a viewfinder mechanism.

COSMICAR will make whatever new lenses you need for your CCTV cameras to satisfy your every CCTV purpose.



FOR YOUR SPECIAL CCTV CAMERAS

For example, COSMICAR lenses can be adopted to automatic or rear control system by one hand.

Superb lenses of proven ability from 12.5mm to 1,000mm and Zoom lenses are on sale.

For further details, write to:



COSMICAR OPTICAL CO., LTD.

(Former name: ICHIZUKA OPTICAL CO., LTD.)

568, Shimoochiai, 2-chome, Shinjuku-ku, Tokyo Cable Address: "MOVIEKINO TOKYO"

Circle 274 on reader service card

Electronics | July 8, 1968

5 o'clock shadow

Migration and whisker growth of tin and solders induced on thin metal films by direct current and heat
G.M. Bouton and W.G. Bader
Bell Telephone Laboratories,
Murray Hill, N.J.

Too much current can make a thin-film tantalum-nitride resistor look old—and perhaps cause circuit failures. The device grows whiskers. In one case, 100 milliamperes flowing through a 50-ohm resistor on an alumina substrate generated whiskers in a few days that started at the juncture of the tantalum nitride and the soldered positive-polarity termination.

Other current magnitudes create different types of growths. On a 50-ohm-per-square resistor, 20 ma produced spheres, 180 ma produced ribbons and fine whiskers as well as spheres, and 160 ma created masses of fast-growing fine whiskers.

Solderable areas at the terminals are formed when successive layers of nickel chromium, copper, and palladium are evaporated over the tantalum nitride. Growths occur most rapidly on circuits in which the heat from the soldering operation causes the thin copper layer to dissolve into the solder. This exposes the nickel-chromium layer to the solder.

Tests show nickel-chromium alloys are susceptible to whisker growths, while nickel, chromium, titanium, tantalum, and tantalum-nitride films aren't. Usually, a nickel-chromium alloy is very difficult to wet with solder. However, a freshly cut piece of tin (a major constituent of solder) will react with nickel-chromium when heated above the tin's melting point of 232°C for four hours.

The tin diffuses through the alloy and needles and whiskers start to form and grow. The growth

rate, which depends on current, time, and temperature, can be as fast as 1 millimeter a minute.

A thick copper layer may prevent whiskers.

Presented at the IEEE-EIA 1968 Electronics Components Conference, Washington, May 8-10

Light altimeter

Low-altitude laser measurement system
James E. Hopson
Raytheon Co., Lexington, Mass.
William D. Isaac
USAF Institute of Technology,
Wright-Patterson AFB, Ohio
Rudy C. Beavin and Paul Polishuk
Flight Dynamics Laboratory,
Wright-Patterson AFB

An experimental laser system for measuring an aircraft's altitude as it comes in for a landing has been tested aboard a Convair 440. The results indicate that a small, light-weight laser altimeter applying current solid state technology can

Fuseholders of Unquestioned High Quality

THE COMPLETE LINE OF *Small Dimension* FUSES

For The Protection of All Types of Electronic and Electrical Circuits and Devices . . .

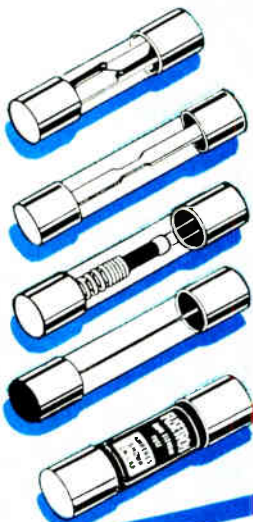

. . . includes dual-element "slow-blowing", single-element "quick-acting" and signal or visual indicating types . . . in sizes from 1/500 amp. up.

For special fuses, clips, blocks or holders, our staff of fuse engineers is at your service to help in selecting or designing the fuse or fuse mounting best suited to your requirements.

Write for BUSS Form SFB

INSIST ON
BUSS QUALITY
FUSES

BUSSMANN MFG. DIVISION, McGraw-Edison Co. St. Louis, Mo. 63107
Circle 203 on reader service card

SUB-MINIATURE FUSES

Ideal for space tight applications, light weight, vibration and shock resistant. For use as part of miniaturized integrated circuit, large multi-circuit electronic systems, computers, printed circuit boards, all electronic circuitry.

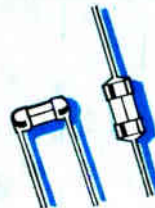

TRON Sub-miniature Pigtail

Fuses — Body size only .145 × .300 inches. Glass tube construction permits visual inspection of element. Hermetically sealed. Twenty-three ampere sizes from 1/100 thru 15.



BUSS Sub-miniature GMW Fuse and HWA Fuseholder

Fuse size only .270 × .250 inches. Fuse has window for visual inspection of element. Fuse may be used with or without holder. 1/200 to 5 amp. Fuses and holders meet Military Specifications.

Write for BUSS Form SFB

INSIST ON
BUSS QUALITY
FUSES

BUSSMANN MFG. DIVISION, McGraw-Edison Co. St. Louis, Mo. 63107
Circle 203 on reader service card

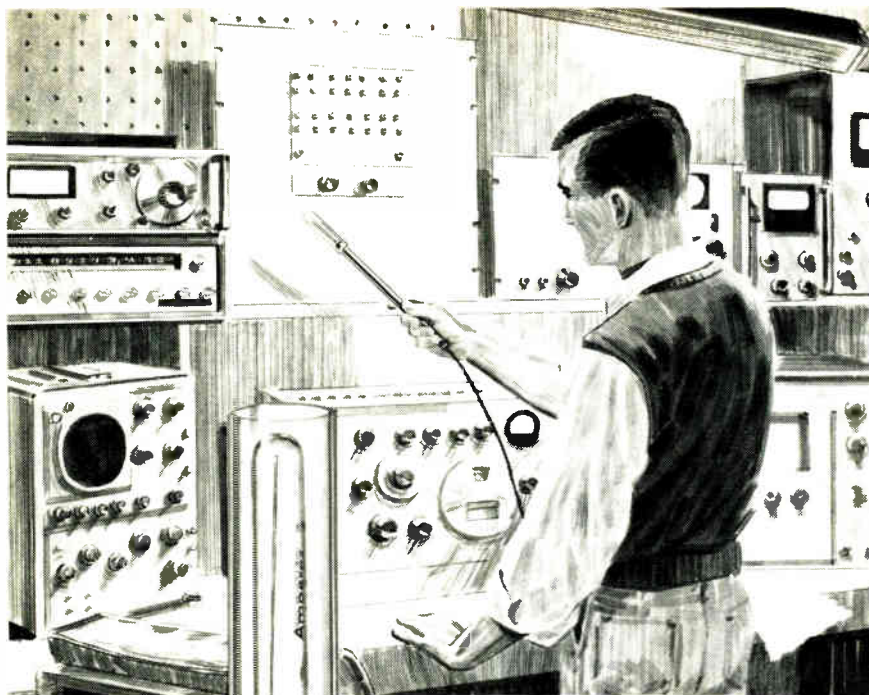

Play it **SAFE!**

check microwave radiation hazards

with International's Microlite-287

This handy test light provides an instrument for safety checks in the laboratory or other areas where microwave radiation may be a hazard. The Microlite-287 was designed for testing radiation from microwave ovens at 2450 MHz. In this service it indicates fields of 10 MW/CM² or more. It may be used for testing other ranges of radiation and can be calibrated to indicate glow level. Connect to nearest 115 vac outlet and it's ready to use. Store in drawer or tool box. Unit shipped complete with instructions. **\$26.00** f.o.b. Okla. City.

Write for our complete catalog.



CRYSTAL MFG. CO., INC.
10 NO. LEE • OKLA. CITY, OKLA. 73102

Technical Abstracts

provide precise and accurate altitude measurements.

The system, called Lalms for low-altitude laser measurement system, uses as a signal source an RCA TA2930 gallium-arsenide diode operating in a pulsed mode. Light from the laser is reflected from the ground into a photodetector on the aircraft. The measured altitude depends on the time it takes the light to make the round trip.

Transmitted laser light—20-nano-second pulses have given 100 watts peak with a rise time of less than 5 nanoseconds—is sampled by a small mirror in the beam and is used to illuminate a silicon photodiode. This reference signal is fed to a tunnel-diode discriminator that processes it and provides a standard start signal for triggering the external time-interval counter.

Laser light, triggered at a 1,000-hertz rate and reflected from the target, is received by an optical system, spatially filtered by an aperture plate, and passed through a narrow-bandwidth optical filter onto the surface of a 10-stage photomultiplier tube. The output of the tube is amplified and processed by another tunnel-diode discriminator, which generates the stop signal for the counter. The system is designed so that accuracy is independent of target range or of pulse-to-pulse variation in laser power or target reflectivity.

Different kinds of target materials were used in lab tests, including white and gray poster board and brown wrapping paper. Distances to the targets were 100, 49, and 28.5 feet. Standard deviations of measurements ranged from 0.06 to 0.12 foot.

Flight tests were conducted over an airport runway and the grassy strip alongside, at altitudes from 29.51 to 163.89 feet. Maximum standard deviation was 0.7 foot over the runway and 0.31 foot over the grass.

Several runs were also made over a set of bleachers at the end of the runway. The readings clearly showed the stepwise configuration of the bleacher seats.

Presented at NAECON, Dayton, Ohio
May 6-8

DOWN THE HATCH!

New 5 KVA audio power amplifier

Designed to go down the hatch of submarines, the model S5K is a workhorse audio source for ship or shore. The unit delivers 5 KVA CW and 15 KVA instantaneous peak power from 100 to 10,000 cps. Full power is available into reactive loads . . . **no power factor correction needed.**

Another CML exclusive: selectable output taps for wide range load matching.

Other power sources from 70 VA to 200 KVA.

Call or write today.

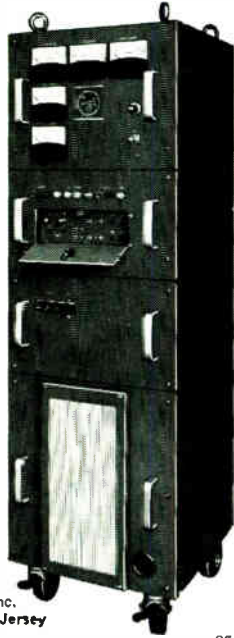

CML, Inc.

A subsidiary of Tenney Engineering, Inc.
350 Leland Avenue • Plainfield, New Jersey
(201) 754-5502 • TWX: 710-997-9529

R7A

Circle 275 on reader service card

Copper-Clad Laminates Ready For Immediate Shipment

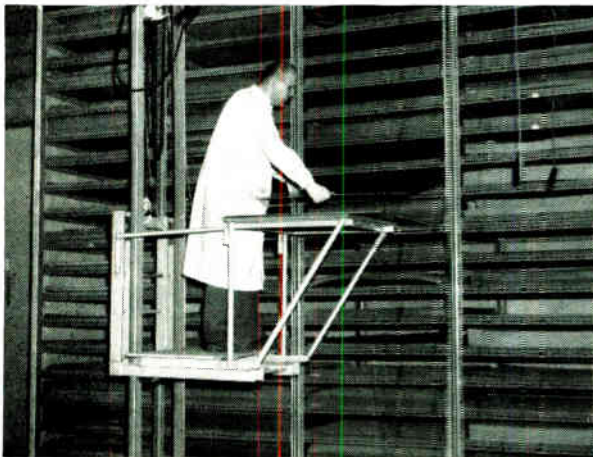

Our new and greatly increased warehouse facilities make it possible for us to produce and store a large quantity of copper-clad sheet laminates. All first-quality Synthane. Clad on one or both sides. Range of thicknesses and sizes. Thin copper-clad laminates. Also a very large inventory of B-stage pre-preg, ready to laminate on short notice. Call our district representative nearest you (see Yellow Pages) or phone us direct (215) 666-5011. Synthane Corporation, 36 River Road, Oaks, Pa. 19456.

SYNTHANE
CORPORATION  OAKS, PA. 19456

Laminated Plastic Sheets, Rods, Tubes and Fabricated Parts

Circle 276 on reader service card

Quickly snap PC boards on or off a chassis

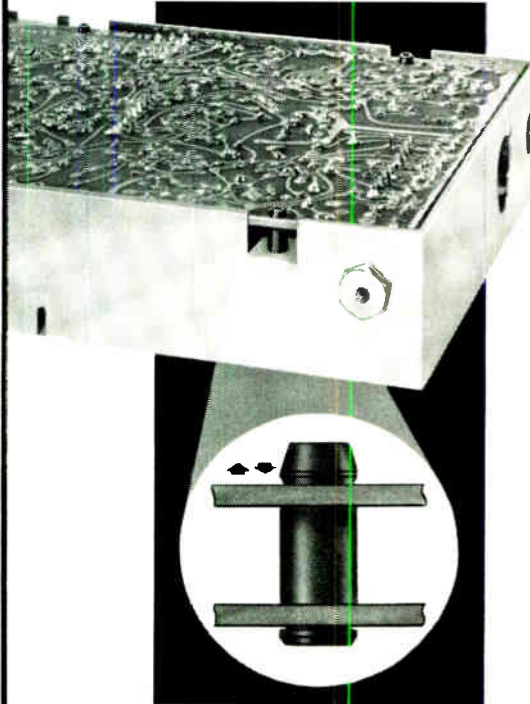

with Johnson spacer/bushings

Now you can mount and insulate PC boards to panels or metal chassis without the use of nuts, bolts, and hollow spacers. When the grommet end of a Johnson polyamide spacer/bushing is snapped in pre-drilled or punched holes on the chassis or panel, it is in place to stay! The PC board, on the other hand, can be easily snapped on or off the opposite end of the spacer/bushings to facilitate service or modifications.

Machined from polyamide, Johnson spacer/bushings are designed for use on any 1/16" thick PC board, chassis or panel. By providing a mechanically secure, non-conductive, convenient mounting method, Johnson spacer/bushings can cut production time and costs substantially.

FREE CATALOG includes specs and prices on these and other high quality E. F. Johnson components. See your E. F. Johnson representative or write for your copy today.



E. F. JOHNSON COMPANY

3064 Tenth Ave. S.W., Waseca, Minnesota 56093

Providing nearly a half-century of communications leadership

Circle 205 on reader service card

205



GREATER TAPE SENSITIVITY

with Pfizer
magnetic iron oxides

Whenever there's a need for a more versatile magnetic tape with a high output, chances are Pfizer has the magnetic oxide for you to produce it. Significant advances in magnetic tape technology have coincided with Pfizer's continuing development of high quality oxides. Available are IRN[®] magnetic oxides of high density which facilitate more magnetic action in a given volume, providing greater sensitivity in a wide variety of uses:

- Audio, video, computer and instrumentation tapes;
- Memory drums and discs;
- Cinema film stripings;
- Magnetic inks;
- Transfer tapes;
- Ribbons.

FYI*

Pfizer is also pleased to announce the availability of Ultralap—a new emulsion-coated, bonded abrasive on a polyester back—available with many different materials and grit sizes—providing amazing effectiveness and durability. For complete technical data, please write.

*For Your Information

Pioneering in Physical Chemicals

MINERALS PIGMENTS & METALS DIVISION

Dept. 75, 235 East 42nd Street
New York, New York 10017

New Literature

Oscillators. Allen Electronics Division, Allen Organ Co., Macungie, Pa. 18062. Detailed specifications of the type C audio oscillator and type P plug-in sine-wave oscillator are featured in a catalog sheet.

Circle 446 on reader service card.

Tape readers. General Electric Co., 511 North Broad St., Philadelphia 19123. Eight-page brochure GEA-8492 describes a line of photoelectric tape readers, reelers, and reader-reeler combinations. [447]

Fluids dispenser. Headway Research Inc., 3713 Forest Lane, Garland, Texas 75040, offers a brochure on the EC102-NRD dispenser, which was designed to work in conjunction with the EC100 photoresist spinner. [448]

Digital automation technique. Theta Instrument Corp., 22 Spielman Rd., Fairfield, N.J. 07006. A method for automating machinery, processes, and instruments with encoders and encoding systems is described in a four-page bulletin. [449]

Thermocouple system calibrator. General Resistance Inc., 430 Southern Blvd., Bronx, N.Y. 10455. Bulletin 804 illustrates and describes the model DAS46CJC thermocouple system calibrator. [450]

Temperature controllers. Burling Instrument Co., 16 River Rd. Chatham, N.J. 07928. Six-page condensed catalog G-33 describes a line of temperature controllers. [451]

Miniature r-f connectors. Sealectro Corp., 225 Hoyt St., Mamaroneck, N.Y. 10543, has available a catalog on the SRM series of miniature r-f connectors, which meet or exceed requirements of MIL-C-39012. [452]

Strip-chart recorder. West Instrument Corp., 3860 North River Rd., Schiller Park, Ill. 60176, has released bulletin FS describing a strip-chart recorder capable of recording up to six variables simultaneously. [453]

Avalanche diode sources. Frequency Sources Inc., P.O. Box 159, North Chelmsford, Mass. 01863. A four-page brochure describes in detail the FS-40 series avalanche diode sources. [454]

IC core memories. Computer Control Division, Honeywell Inc., Old Connecticut Path, Framingham, Mass. 01701, offers a brochure summarizing key operating specifications for its line of IC core memories. [455]

Directional coupler. Sage Laboratories Inc., 3 Huron Dr., Natick, Mass. 01760, has issued a 20-page applica-

tions guide, "The Microwave Directional Coupler." [456]

Microwave tubes. S-F-D Laboratories Inc., 800 Rahway Ave., Union, N.J. 07083, has available a six-page catalog on microwave tubes for advanced systems. [457]

Data communication products. Milgo Electronic Corp., 7620 N.W. 36th Ave., Miami, Fla. 33147. An illustrated folder describes a line of data communication products. [458]

Photoresist. Shipley Co., 2300 Washington St., Newton, Mass. 02162. Bulletin S-1350 describes AZ-1350H, a positive-working photoresist engineered for IC applications. [459]

Recording oscillograph. Consolidated Electro-dynamics Corp., 360 Sierra Madre Villa, Pasadena, Calif. 91109. Type 5-119 Datagraph recording oscillograph is described in an eight-page brochure. [460]

Silicon rectifiers. Edal Industries Inc., 4 Short Beach Rd., East Haven, Conn. 06512. Bulletin 115 offers full specifications on a line of silicon rectifier miniature single-phase bridges. [461]

Coaxial adapters. Weinschel Engineering, Gaithersburg, Md. 20760. Model 1513 precision coaxial adapters that cover the frequency range from d-c to 18 Ghz are described in a catalog data sheet. [462]

Photomultiplier tube housings. Pacific Photometric Instruments, 3024 Ashby Ave., Berkeley, Calif. 94705. A 16-page catalog contains specifications and dimensions for 10 types of photomultiplier tube housings. [463]

Plug-in power supplies. Acopian Corp., Easton, Pa. 18042, offers literature that describes 21 new a-c to d-c plug-in power supplies. [464]

Data set. Sangamo Electric Co., Box 359, Springfield, Ill. 62705. A four-page bulletin highlights the functions and features of the Transidata T401E data set. [465]

Relays and coils. Solid State Electronics Corp., 15321 Rayen St., Sepulveda, Calif. 91343, offers a 48-page catalog describing its line of miniaturized, ruggedized relays and coils. [466]

Computerized testing. Arma Division, Ambac Industries Inc., Roosevelt Field, Garden City, N.Y. A four-page publication describes an automatic computerized testing system, detailing its application to a variety of electronic and electromechanical equipment. [467]

New Dumet... Dip- Formed



General Electric's new dip-formed Dumet F offers 15% better electrical and thermal conductivity — assured weldability and sealability — unbrazed, metallurgically bonded core and sheath — increased copper purity — longer continuous lengths without welds. Available forms: spools, cut straights, welded lead wires. Also available in gold, nickel and other platings. Used in electronics, semiconductors or lamps. For details on Dumet F, write or call: General Electric Company, Lamp Metals & Components Department, 21800 Tungsten Road, Cleveland, Ohio 44117. Tel: (216) 266-3472.

Available forms: spools, cut straights, welded lead wires. Also available in gold, nickel and other platings. Used in electronics, semiconductors or lamps. For details on Dumet F, write or call: General Electric Company, Lamp Metals & Components Department, 21800 Tungsten Road, Cleveland, Ohio 44117. Tel: (216) 266-3472.

GENERAL ELECTRIC

Circle 277 on reader service card

intellux has flipped and gone dip

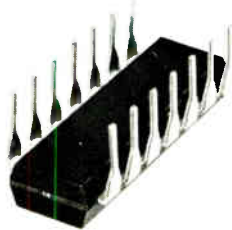

Our 1st . . . is a 100 mA hex driver for lamps or relays with diode suppression, driven directly from DTL or TTL.

Flip chip semiconductors are mounted on thin film multilayer substrates . . . all in a 16 pin dual-in-line package.

We can ship the hex driver to you tomorrow, or this technique can be applied to your special. Try us.

intellux

SUBSIDIARY — HARVEY RADIO CO., INC.

26 COROMAR DRIVE ■ GOLETA, CALIFORNIA 93017

Circle 278 on reader service card

NEW. Low Frequency Ceramic Band Pass Filter.

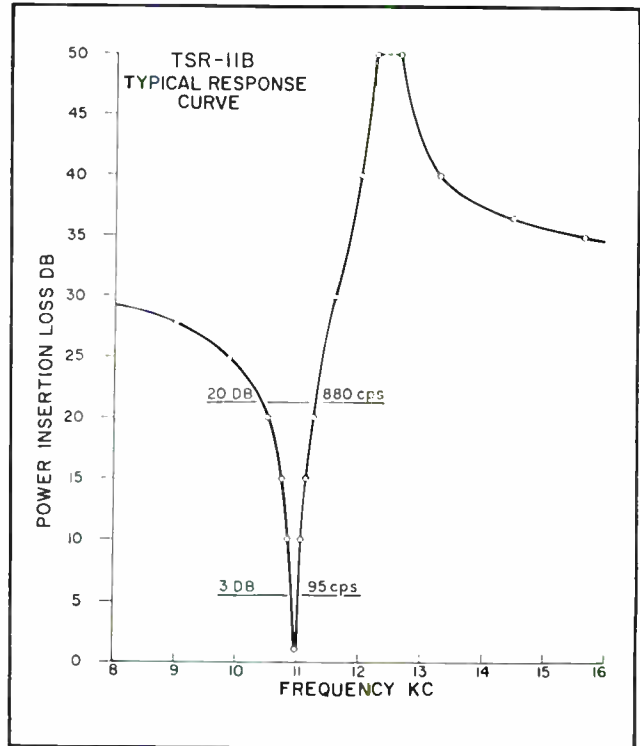
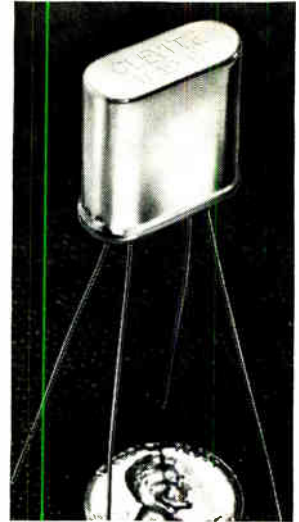

Big performance in a quarter ounce package.

Looking for something better in a low frequency filter? Look no more. Clevite's new generation of fixed-tuned ceramic band pass filters combine narrow bandwidths and high performance with surprisingly small size and low weight.

Check the specs and see for yourself:

Center Frequency — from 9kc to 50kc

Bandwidth (% fo) — @ 3db-1%; @ 20db-13%

Stability — Within 0.2% for 5 years

Within 0.2% from -40°C to +85°C

Dimensions — HC-6/U case 3/4" x 3/4" x .34" (hermetically sealed)

Shock — 20g any axis 20-2000 cps per mil std. 202B.

As we said, look no more for a high performance, low frequency filter. This new one from Clevite is the perfect choice. Write for free Technical Bulletin 94023. Clevite Corporation, Piezoelectric Division, 232 Forbes Road, Bedford, Ohio 44014.

CLEVITE

Circle 207 on reader service card

207

The day Albert Jones conceived a new IR test technique

Technically, it was the day after he and Frank Porter, AGE major domo, agreed there was a problem. No combination of available components could field-test the aircraft IR sensor practically. "Well," said Al, "looks like we start from scratch." Which understated the problem, since they'd only 6 months to develop a working prototype. Al left Frank with a "Don't worry". But he'd already started worrying.

At home, Al popped the family off to bed after an evening's TV... and pondered. Everything seemed to hinge on the weight. Even latheways cast in magnesium or aluminum clocked in at 1500 lbs.; available sensor-holding units hit the scales at 300+. What was needed would have to weigh far less. So, he gave it considerable thought.

With considerable success. Resulting in the basic parameters for a portable, air-transportable, autocollimated, lab quality optical bench. Capable of ultranarrowband spectral analysis; sensitivity checkout; testing resolution and total field of view, with micrometer sensor positioning and a built-in substitute cryo-source. Total weight: 300 lbs!

Funny thing about Al. He doesn't consider what he did especially unusual. It's typical of the all-of-a-sudden problems that crop up in developing multi-function AGE systems whose frequencies run from DC to light. And, he's gotten used to pioneering ideas like automated test equipment using a time-shared central computer. He likes it. All of it.

If there are any more of you out there like Al, why not investigate what our AGE laboratory can offer you. Even if you'd prefer to pit your intellect against a provocative study or development program in another advanced area, we'd like to hear from you: we'll tell you about ongoing programs in our radio communications, navigation aids, data equipment, countermeasures and tracking systems labs.

Direct your resume, in confidence, to Mr. J. P. O'Reilly, Dept. 186.



GENERAL DYNAMICS

Electronics Division

1400 N. Goodman Street, Rochester, New York 14601

We are an equal opportunity employer in deed,
not only an equal opportunity employer in words.

SEARCHLIGHT SECTION

- CLASSIFIED ADVERTISING
- BUSINESS OPPORTUNITIES
- USED OR SURPLUS EQUIPMENT

AUTOTRACK ANTENNA MOUNT

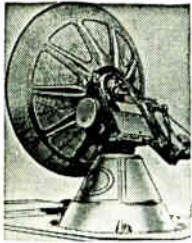

360 degree azimuth, 210 degree elevation sweep with better than 1 mill accuracy. Missile velocity acceleration and slewing rates. Amplidyne and servo control. Will handle up to 20 ft. dish. Supplied complete with control chassis. In stock—immediate delivery. Used world over by NASA, USAF, MP-61-B, Type SCR-584, Nike Ajax mounts also in stock.

PULSE MODULATORS

MIT MODEL 9 PULSER 1 MW—HARD TUBE

Output 25kv 40 amp., 50kv 40 amp. max. Duty cy. .002, .25 to 2 microsec. Also .5 to 5 microsec. and .1 to .5 microsec. Uses 6C21. Input 115v 60 cycle AC. Mfg. GE. Complete with driver and high voltage power supply. Ref: MIT Rad. Lab. Series, Vol. 5, p. 152

2 MEGAWATT PULSER

Output 30 kv at 70 amp. Duty cycle .001. Rep rates 1 microsec 600 pps. 1 or 2 msec 300 pps. Uses 5848 hydrogen thyratron. Input 120/208 VAC 60 cycle. Mfr. GE. Complete with high voltage power supply.

250 KW HARD TUBE PULSER

Output 16 kv 16 amp. Duty cycle .002. Pulses can be coded. Uses 5D21, 715C or 4PR60A. Input 115 v 60 cy. AC \$1200 ea.

18 MEGAWATT PULSER

Output 150KV at 120 amps. Rep rate: 50-500 PPS. Pulse length: 5 msec. 15KV 120 amp. into pulse transformer. Rise time 1.5 msec. Filament supply 5V 80 amp. incl. 17.5KV 1.5 amp DC power supply. Input: 220V 60 cy AC.

INDICATOR CONSOLES

AN/SRA-1A, PPI 10", range to 200 mi. VJ-1 PPI 12". Range to 200 mi. VL-1 RH 12" to 200 mi. 60K It.

HIGH VOLTAGE POWER SUPPLIES

100KV, 200MA, DC, \$7500; 27 KV, 100MA, DC, \$2200; 15KV, 2 amp. DC, \$1800; 12KV, 1200MA, DC, \$1400; 8KV, 800MA, DC, \$975.

SCR 584 AUTOTRACK RADARS

Our 584s in like new condition, ready to go, and in stock for immediate delivery. Ideal for telemetry research and development, missile tracking, satellite tracking. Fully Desc. MIT Rad. Lab. Series, Vol. 1, pps. 207-210, 228, 284-286. Comp. Inst. Bk available \$25.00 each.

SONAR SYSTEMS IN STOCK

AN/FQS-1A, AN/UQS-1B, QH1Ba scanning sonars. Rochelle salt hydrophones 6 ft. \$150 ea.

MICROWAVE SYSTEMS

200-2400 mc. RF PKG

Continuous coverage, 300 watts CW nominal output. Uses 2X3A. Price \$755.

L BAND RF PKG.

20 KW peak 990 to 1040 MC. Pulse width .7 to 1.2 micro sec. Rep rate 180 to 420 pps. Input 115 vac incl. Receiver \$1200

200-225 mc RADAR SYSTEM

1 Megawatt output. 200 nautical mile range for long range detection of medium and high altitude jet aircraft as well as general search. AN/TPS-28.

SURVEILLANCE DRONE RADAR SYSTEM

X-Band tracking system with plotting boards. Type AN/MPQ-29. Drone also in stock.

5 MEGAWATT C-BAND

Klystron RF package delivering nominal 5 megawatt pulse RF. Complete with pulser and power supply.

500 KW L BAND RADAR

500 kw 1220-1359 mps. 160 nautical mile search range P.P.I. and A scopes. MTI thyratron mod 5J28 magnetron. Complete system

AN/GPG-1 SKY-SWEEP TRACKER

3 cm. automatic tracking radar system. Complete package with indicator system. Full target acquisition and automatic tracking. Input 115 volts 60 cycle. New. In stock for immediate delivery. Entire system 6' long, 3' wide, 10" high. Ideal for Infrared Tracker, Drone Tracker, Missile Tracker. R. & D.



500KW S BAND RADAR

250 miles search 115V 60 cy AC. Mfg. G.E.

RADAR SYSTEMS GROUND AND AIRBORNE. AUTOMATIC TRACKING ANTENNA SYSTEMS. NIKE AJAX. NIKE HERCULES M-33 MSQ-1A. MPS-19. MPS-9. SCR 584. TPS-1D. TPS-28. FAA-ASR-2. AIRBORNE SYSTEMS. APN-84. APN-102. APS-20. APS-27. APS-45. DPN-19. DIGITAL COMPUTERS. IBM 650. IBM 704.

LARGEST INVENTORY OF RADAR AND MICROWAVE EQUIPMENT IN THE WORLD.
RADIO RESEARCH INSTRUMENT CO.
45 WEST 45TH ST. N. Y. 10036 212-JU-6491

CIRCLE 93 ON READER SERVICE CARD

GET IT from GOODHEART!

0.01% SORENSEN Line Voltage Regulator

±1001 regul. against load changes 0-1 kva & line changes 95-130 v. 1 ph 55/65 cy; adj. output 110-120 v; holds to 0.01%. Distortion max. 3%. Response 0.1 sec. Regularly \$570.00. From us, OK



grtd. only \$275.00

±2501 is same but 0-2.5 kva. \$375.00

±5005 is same, 0.5 kva. 0.1%. \$89.50

±10005 is same, 1 kva. 0.1%. \$99.50

±20005 is same, 2 kva. 0.1%. \$179.50

Sup. Electric #IE-5102 is same spec. electronic regul., but 2 1/2 kva, 0.1%. \$199.50

Sup. Elect. IE-20060: 3 kva. Same specs as above but MIL-spec built, all potted xfmr's, etc. Behind rack panel 21" h. 14 1/2" dp. no cabinet. Regular \$900. NEW, export boxed, 330# fob Utica, N.Y. (Cabinet for above \$30 fob Utica.) \$279.50

Sorensen R5010 all-solid-state, zener reference, 0-5 kva. 90% efficient. Regular \$792. With cabinet \$450.00

Sup. Elect. IE-5105: Same specs as Sorensen "S" series, 0-5 kva, regularly \$655.00. Only \$349.50

Sorensen 10,000S: Same specs as all above, but 0-10 kva. Regular \$1272. With spares, 670# \$695.00

ALL ABOVE are 1 ph 95-130 v. Two below are 1 ph 190-250 v in, adjust. 220-240 v out, 0-5 kva. Same specs, choose Sorensen 5000-2S or Sup. IE-52051¹ specs, choose Sorensen 5000-2S or Sup. IE-52051¹ (Picture is #5000-2S.) \$349.50

Above are electronic. Following are electromech. A servo system senses output, turns a Vario or Powerstat, corrects to 1% very fast. Life tested 99 years. 47-63 cy OK. AND NO DISTORTION!

Gen. Radio #1570AL: 0-6 kva, regular \$530. From us only \$199.50

Sup. Elect. EM-4106 in upright metered cabinet, 0-6 kva. \$199.50

Sup. Elect. EM-4115 in metered cabinet, 1 ph 0-15 kva. \$295.00

Above are all 95-130 v; 190-260 v follows:

Sup. Elect. EM-4228, 1 ph, 0-27 1/2 kva, regular \$750. New. \$495.00

EMT 6220Y (transistorized) 3 ph 20 kva, \$1200 value, only \$450.00

L&N #1725 .05% Wheatstone Bridge, J's thru K's, X.0001 thru X10K. OK grtd \$227.50

Gen. Radio #805C, #1001A; Meas. Corp. #65H; #80; #80R; Hammon 225A, 240A; & other signal generators, also high-power types. \$ASK!

MARCONI FM DEVIATION METER TF-934, regularly \$890. Reads dev. w/ ranges 5, 25, 75 kc. Has audio monitor. Made for MIL, 2 1/2-100 mc, easily reaches 1000 mc on harmonics; we include all instructions. Checked out, ready to use. \$179.50

Lavoie LA-70A & Gertsch FM-3A Freq. Meters. \$ASK!

Tektronix 541A, 551A, Hewl. P. & other scopes. \$ASK!

SP-600's & R-392 late-model Radio Receivers. \$ASK!

Automichron Cesium-Beam Freq. Standard. \$ASK!

Regulated Power Supplies, Meter Calibrators. \$ASK!

All kinds of AUDIO Test Equipment. \$ASK!

Graphic Recorders at very low prices. \$ASK!

Counters, Freq. Meters, DVM's. \$ASK!

Precision Meters NBS-traceable Certified. \$ASK!

Spectrum Analyzers & Plug-Ins. \$ASK!

Bridges, Potentiometers, other Lab Standards. \$ASK!

Electronic & Rotary Frequency Converters. \$ASK!

Noise & Field Strength Meters. \$ASK!

WE PROBABLY HAVE THE BEST INVENTORY OF GOOD LAB TEST EQUIPMENT IN THE COUNTRY, BUT PLEASE DO NOT ASK FOR CATALOG! ASK FOR SPECIFIC ITEMS OR KINDS OF ITEMS YOU NEED! WE ALSO BUY! WHAT DO YOU HAVE?

R. E. GOODHEART CO. INC.
Box 1220-E, Beverly Hills, Calif. 90213
Phones: Area 213, office 272-5707, messages 275-5342

CIRCLE 951 ON READER SERVICE CARD

ELECTRON TUBES

KLYSTRONS • ATR & TR • MAGNETRONS
SUBMINIATURES • C.R.T. • T.W.T. • 5000-
6000 SERIES

• SEND FOR NEW CATALOG A2 •
A & A ELECTRONICS CORP.
1063 PERRY ANNEX
WHITTIER, CALIF.
696-7544

CIRCLE 952 ON READER SERVICE CARD

EMPLOYMENT OPPORTUNITIES

SEND NEW ADS TO:

Classified Advertising Div.

P.O. Box 12, N.Y., N.Y. 10036

ADDRESS BOX NO. REPLIES TO: Box No. Classified Adv. Div. of this publication. Send to office nearest you.
NEW YORK, N. Y. 10036: P. O. Box 12
CHICAGO, Ill. 60611: 645 N. Michigan Ave.
SAN FRANCISCO, Cal. 94111: 255 California St.

POSITION WANTED

Young Honours Graduate Electrical Engineer (London U.K.) Wants to broaden experience. Will relocate and will consider any reasonable offer. PW-5930, Electronics.

What is your problem?

Competent men for your staff? . . . employment? . . . or are you looking for—or offering—a business opportunity of special interest to readers of this publication? You can get their attention—through an advertisement in the Employment Section of Electronics.

Send New Ads to:

ELECTRONICS
Class Adv. Div., P. O. Box 12,
N. Y., N. Y. 10036



LOOKING FOR AN IC SUPPLY TO MATCH THE QUALITY OF YOUR MICROCIRCUITS?

KEPCO HAS THE ANSWER!

The CPS Power Supplies with redundant overvoltage security for delicate IC's.

Offered in two versions, fully metered and equipped with the usual assortment of panel controls for lab-bench use, or in modular form—with recessed (screwdriver adjusted) controls, Kepeco's CPS Power Supplies are the perfect low voltage precision sources for critical microcircuits.

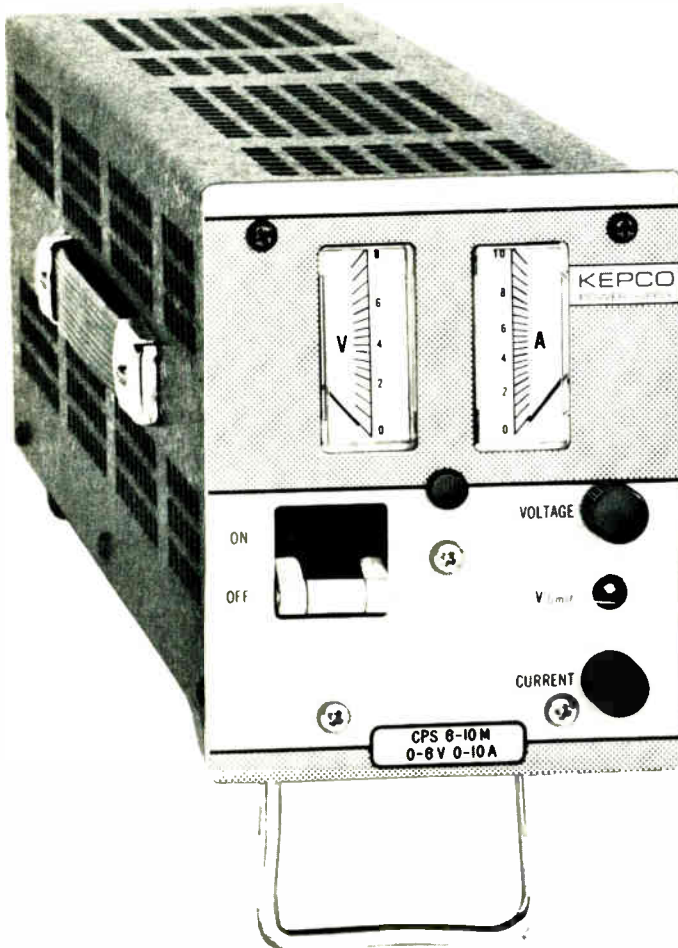

MODEL	DC OUTPUT RANGE		STYLE	PRICE
	VOLTS	AMPS		
CPS 6-10M	0-6	0-10	lab-panel	\$350.00
CPS 6-10	0-6	0-10	OEM-modular	320.00
CPS 15-6M	0-15	0-6	lab-panel	350.00
CPS 15-6	0-15	0-6	OEM-modular	320.00

All models employ a new fully dissipative regulator operating linearly without SCR's or switching to regulate 0.005% for line, 0.01% or 0.2 mV for load, and operate from -20 C to +71 C WITHOUT DERATING!

The quarter rack, self-cooled package is FULLY ENCLOSED and equipped with a tilting bail for bench use. Both styles fit rack adapter RA-24 (pre-drilled for slides), which can accommodate up to four power supplies.

The Kepeco CPS models (bench style or OEM modular style) feature a fast-acting built-in overvoltage crowbar whose trip-point is adjustable from the panel (recessed behind the end plate in the modular version). The overvoltage protector features Kepeco's redundant security circuit, with fully independent, fail-safe, reference-comparator and triggering circuit. Timing is from 5-10 microseconds with an adjustable delay to minimize the false alarm rate.

The power supply (as well as the overvoltage protector) is equipped with remote error sensing connections for control and protection directly at the load circuit card. Units may be paralleled or connected in series for driving greater loads.



*We'd be glad to send you the data sheets,
simply write Dept. AH-14 or call:*

KEPCO, INC. • 131-38 SANFORD AVENUE • FLUSHING, N.Y. 11352
(212) 461-7000 • TWX # 710-582-2631
Telex: 12-6055 • Cable: KEPCOPOWER NEWYORK

Newsletter from Abroad

July 8, 1968

Hologram patents disputed in U.K.

Battelle Development Corp. faces a battle in Britain to get its off-axis laser holography technique patented there.

Lined up against Battelle are the Ministry of Technology, Hawker-Siddeley Dynamics, and Agfa-Gevaert, a German-Belgian photo-materials maker.

Although the recording of images by means of optical interference patterns was proposed two decades ago by Dennis Gabor of London's Imperial College of Science and Technology, **Battelle's opposition bases its case not on that but on a British law that makes unpatentable an invention described in public print before the patent application.** Battelle filed for a British patent on Feb. 21 this year. The ministry has offered as evidence eight articles on laser holography that appeared before then.

Battelle acquired the rights to off-axis holography under an invention-development agreement with the University of Michigan, where the first laser holograms were made. The Holotron Corp., a joint venture of Du Pont and a Battelle subsidiary, has the license to Battelle's rights.

U.S. space offer may aid Symphonie

Space authorities in Western Europe are wondering what will result from the lift promised them in late June by the U.S.

At a Munich meeting of the European aerospace trade association, Trevanion Nesbitt, assistant head of the State Department's space office, said Washington was now ready to help countries that want to put up experimental communications satellites. U.S. aid thus far has been limited mainly to research satellites.

Nesbitt said the U.S. would consider almost any proposition, from launching satellites to cooperating in the development of launchers. The offer, though, doesn't apply to projects that would compete with Intel-sat's commercial communications network.

The switch in U.S. policy is a boost for the Franco-German Symphonie satellite project. Its big problem at the moment is getting a satisfactory launch vehicle, **and a firm deal for a U.S. rocket could guarantee its success.** However, officials at the French space agency are skeptical about the offer, largely because nothing came of earlier U.S. proposals of aid to European development programs for missiles and nuclear weapons.

Possible rift clouds startup of Britain's big computer firm

There may be some infighting between former officials of International Computers & Tabulators and English Electric after Britain's "national" computer company, formed by the merger of these firms, starts operations officially this week.

ICT and English Electric were strong rivals for business-computer sales before they were prodded by the government to join forces in International Computers Ltd. **And some insiders say the competitiveness between the two groups will only be dropped when the new company markets a single line of fourth-generation computers in the mid-1970's.** Until then, International will sell both ICT's 1900 machines and English Electric's Series 4 line.

One hint of possible factiousness within International came two weeks ago when ICT announced that it will launch a time-shared com-

Newsletter from Abroad

puter service next January. The utility will initially have the capacity to serve 30 subscribers but will later be expanded to handle about 100. The plan is potentially divisive because English Electric officials are known to have a time-sharing scheme of their own in the works. Two time-sharing services—both using U.S. made computers—are already operating in Britain.

International, though, is taking steps to avoid a split. Along with ICT and English Electric, the Plessey Co. and the government have holdings in the merged company. And International has named as its head a neutral, Sir John Wall, now a ranking Post Office official and before that a managing director of Electrical & Musical Industries Ltd.

Grundig and Ferranti team up for NC sales

Numerical-controls producers are in for some stiff new competition. Two of the strongest European companies in the field—West Germany's Grundig Werke GmbH and Britain's Ferranti Ltd.—plan to pool their NC marketing effort.

The two companies still have to nail down details, but an agreement calling for joint worldwide sales and service operations is in the works. The pact will cover a wide range of NC equipment, from simple positioning controls to multiaxis, continuous-path systems. The firms will also market digital measuring instruments and precision test equipment as a team.

Honeywell to sell a Nippon Electric optical reader

Japanese industry leaders point to Honeywell's agreement to market optical character readers from Nippon Electric Co. as another sign of Japan's advancing computer technology. Honeywell is the first U.S. computer maker undertaking to sell Japanese peripherals to its customers.

Meanwhile, Nippon is busily denying rumors that another Honeywell agreement limits its computer sales to Asia. Nippon insists that it can export the machines—Models 200, 300, and 400 of the Neac 2200 (Honeywell 200) series—anywhere except North America. The rumors started in March, when a new agreement, providing for lower royalties, was signed.

German data links may aid pill-pushing

West German pharmacies may soon be ordering drugs from wholesalers through a nationwide data transmission network. The system the druggists want would place input keyboards at each of the country's 10,000 retail outlets and link them over telephone lines to receivers at wholesalers.

Siemens AG and Standard Elektrik AG—a subsidiary of the International Telephone & Telegraph Corp.—are the most likely suppliers of the network's equipment.

Addenda

West Germany's drive to consolidate its aerospace industry paid off twice in June. Late in the month, Dornier Werke GmbH picked up a 74% holding in Merckle Flugzeugwerke GmbH. Dornier also has an option on the remaining shares in Merckle, a helicopter producer. Earlier, Messerschmitt and Boelkow GmbH merged [Electronics, June 24, p. 204] . . . The Shiba Electric Co. has developed a linear integrated circuit that produces 1.5 watts over a range between 30 hertz and 8 megahertz. The Japanese firm plans to use the circuit in television cameras and other broadcast equipment.

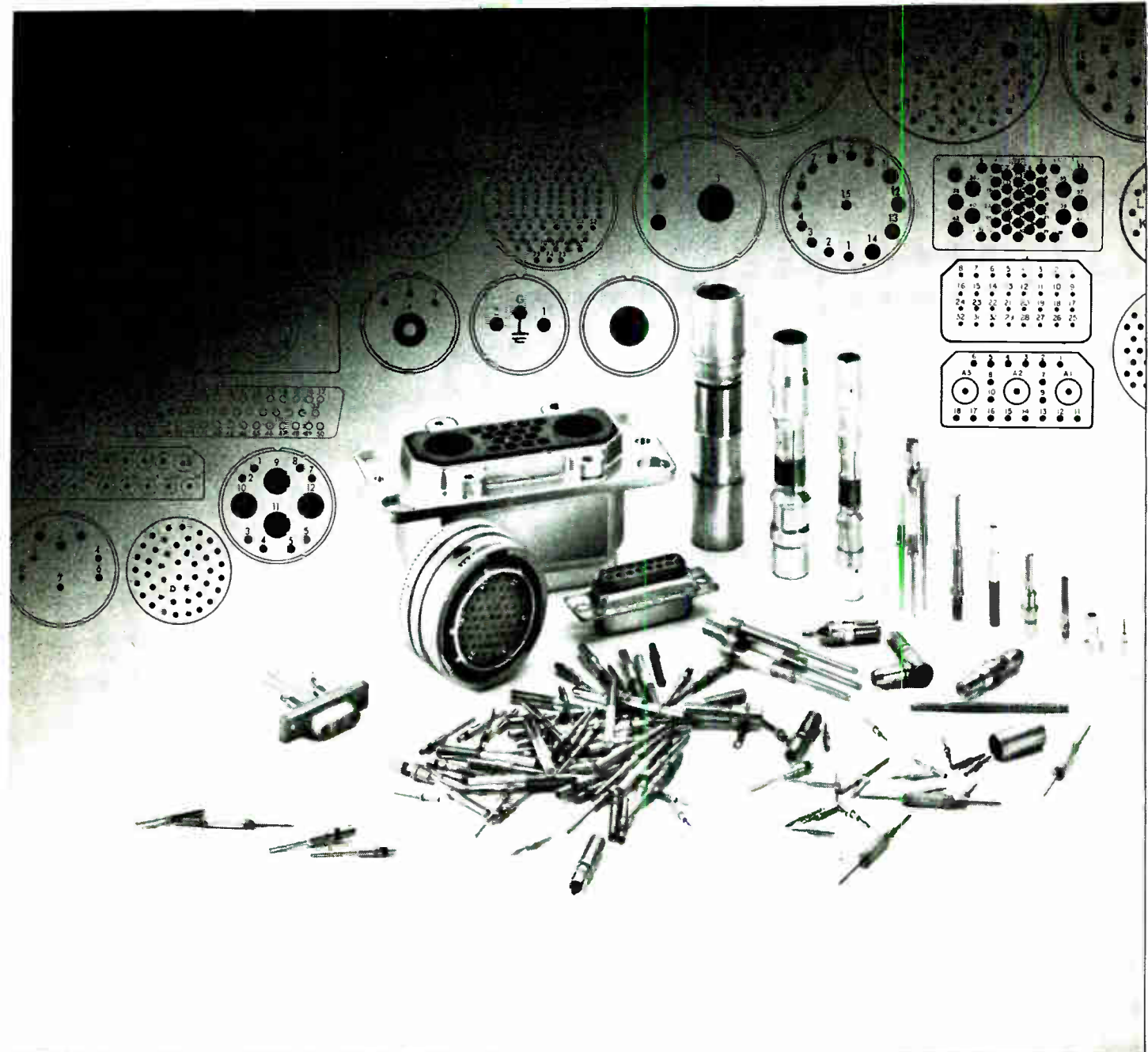

Need to satisfy a multitude of circuit demands?
 Our connectors give you complete interconnection freedom.
 We arranged it that way!

Chances are that a CANNON® Plug already is available with contact types and insert arrangements for your circuit application.

Pick and pack from a wide range of insert arrangements to meet your system requirements... arrangements which include:

Minimum-temperature-rise power contacts. *Bussed* contacts to provide greater circuit flexibility. *The mocouple* contacts with contact material which prevents secondary induced voltages.

Contacts with precious metal surfaces for low-level current and voltages...

dry circuit conditions. *Shielded* contacts to reduce RFI. *RF coaxial* contacts with good impedance matching characteristics.

Filter contacts for attenuation of over 50 db from 100 mhz to 10 ghz.

Printed Circuit contacts designed for consistent contact pressure on printed circuit boards. (These include low-force board insertion systems.)

Microminiature MICROPIN®

contacts with spacings of .050".

Available from ITT Cannon are connectors meeting military and industry specifications in solder, crimp, weld or wire wrap contact designs... all in various sizes, materials and platings.

For our "Contact Technology" paper, write ITT Cannon Electric, 3208 Humboldt Street, Los Angeles, California 90031.

A division of International Telephone and Telegraph Corp.



Circle 213 on reader service card

CANNON ITT

RCA Solid-State Data for Designers

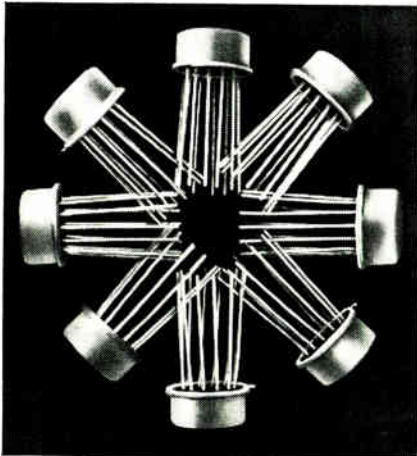
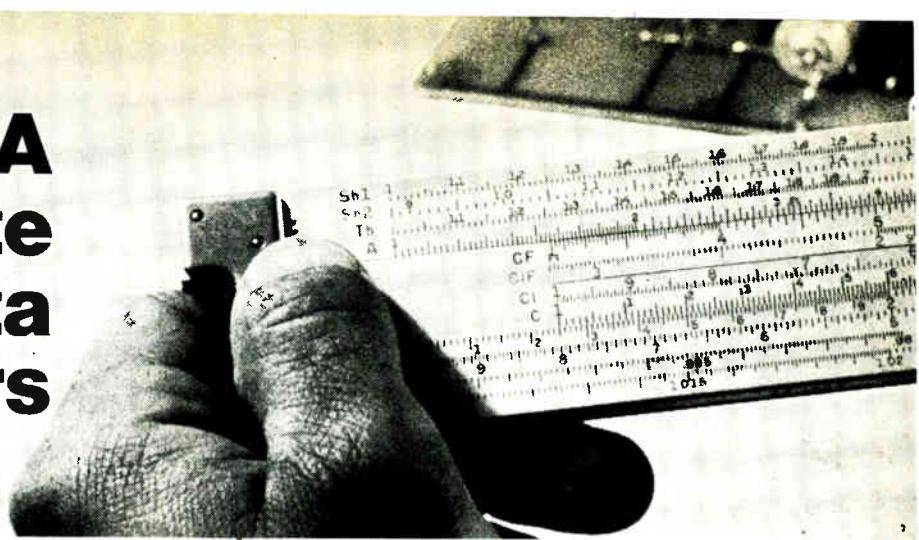

Have You Considered These "UNIVERSAL" Linear IC's?... RCA-CA3020 and CA3020A

Why "Universal"? ... It's applicable from small-signal to power... from DC into VHF. It's ideally suited for a wide spectrum of electronic-design functions... audio, RF, Mixer, IF, servo systems, relay control, signal-light control, frequency multipliers, modulators... and imaginative designers are discovering "lodes" of new ones regularly. CA3020A provides a power gain of 75 dB (typ) and delivers 1 watt (typ) of power output. CA3020 delivers 550 mW (typ). Use them in applications to 8 MHz with resistive loads... into VHF with tuned circuits.

Try the "UNIVERSAL" Linear IC's... RCA CA3020 and CA3020A. Circle Reader Service No. 507 for details.

"Chopper Designers' Delights" RCA-3N153 and 3N138 MOS/FETS

If you have critical industrial chopper and multiplex applications in mind, investigate the RCA 3N153 and the 3N138. Both offer unique advantages over "classical" chopper components.

These two MOS/FET* units feature extremely-low feedback capacitance, low "on" resistance and high "off" resistance—plus virtually zero inherent offset voltage. COMPARE!

Fill in the blanks below in relation to your own application—good, fair, poor?

"Ideal" Criteria	MOS/FET	Bipolar	Electro-mechanical
Infinite life	good	_____	_____
Infinite frequency response	good	_____	_____
Infinite "OFF" resistance	good	_____	_____
Zero "ON" resistance	fair	_____	_____
Zero drive power consumption	good	_____	_____
Zero offset voltage	good	_____	_____
Zero feedthrough between driving signal and signal being chopped	fair	_____	_____
Small size	good	_____	_____
Price (1,000 units)	3N138 \$2.00	_____	_____
	3N153 .96	_____	_____

Circle Reader Service No. 508

*Metal-Oxide Semiconductor/Field-Effect Transistor.

Critical Switching At Up To 50 V/1A in 30 ns Through Inductive Loads? Try This!

The RCA 2N5262 is *great* for high-speed, high-voltage, high-current switching transistor applications.

Hermetically sealed in a low-profile TO-39 metal package, this unit still sells for only 98¢ in 1,000 unit quantities! And look what else you get: safe operation under forward-bias and reverse-bias conditions without second breakdown damage (under specified maximum ratings); 30 ns maximum turn-on and 60 ns maximum turn-off at 1 A I_c , and low saturation voltages. Spec'd to meet MIL-S-19500. Circle Reader Service No. 509.

Look to RCA's PHP MAX VALUE Line...

for hermetically sealed transistors capable of operating over wide temperature ranges.

These silicon n-p-n amplifiers and switches give premium transistor performance at plastic transistor prices—as low as 19¢ for the 2N5183 in quantities of 1,000 or more.

Check your RCA Field Representative for complete information on the RCA 2N5262 and/or RCA's PHP MAX VALUE line of transistors. Ask your RCA Distributor for his prices and delivery. Circle Reader Service No. 510 for the technical bulletin and application information on the RCA 2N5262 and Reader Service No. 511 for information on PHP transistors.

40-A Triac... One of RCA's Hottest New Products

Reaction to our announcement of a 40-A Triac has been spectacular. Sample requests were at a peak and the reasons why are obvious. Now available as the 2N5541 and 2N5442, they are packaged in a press fit and rated at 200 V and 400 V, while the 2N5444 and the 2N5445 are 200-V and 400-V stud packages. They are the highest power handling Triacs in our pace-setting line. Depending upon your line voltage requirements, you can select versions for either 4800- or 9600-watts control. RCA's special pellet design provides surge current protection up to 300 A. Applications include high current heating, furnace and motor controls and power switching systems.

Our assembly lines are now geared up for full production. So if you haven't ordered any 40-A Triacs yet, what are you waiting for? Circle Reader Service No. 512 for details.

How to Get Broadband RF Power Out of the TO-60 Package

One of the problems facing the high frequency designer working with TO-60 packages has been broadband amplification. The principal factor restricting such performance has

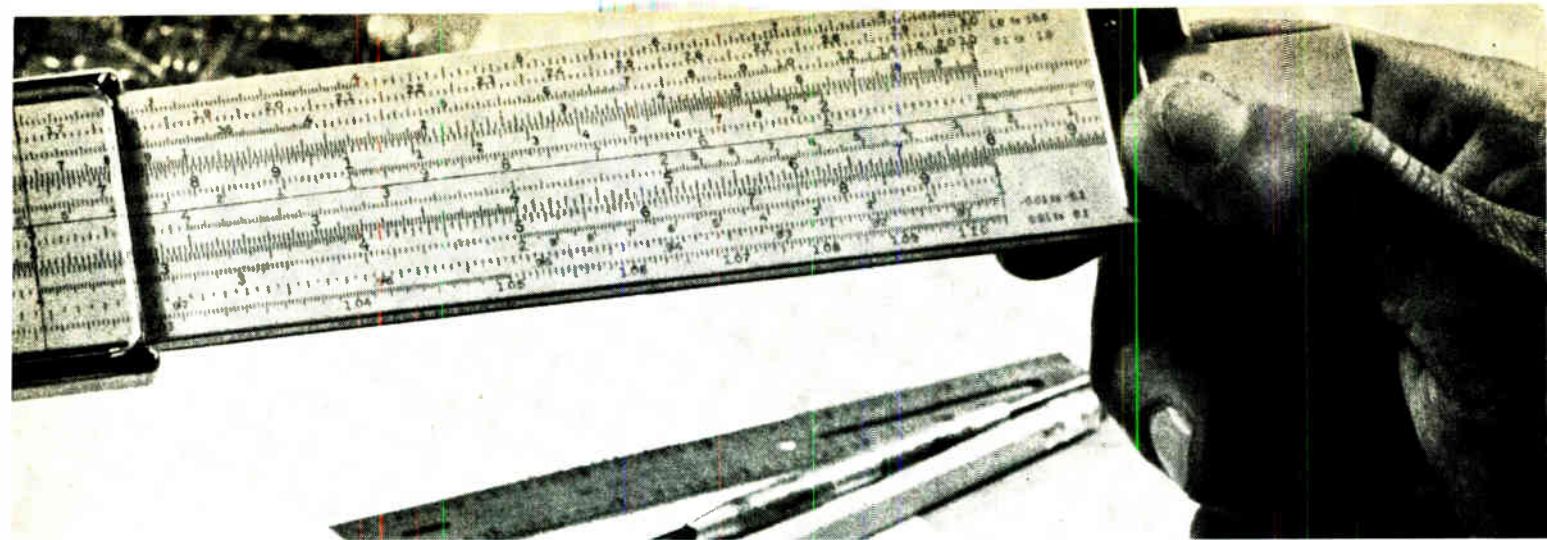

been the parasitic inductance of the TO-60 package. Our Applications Group has, however, recently developed a new circuit technique which permits excellent broadband operation of RCA's 2N5016, a 15-watt (min.) 400-MHz transistor in the TO-60 package.

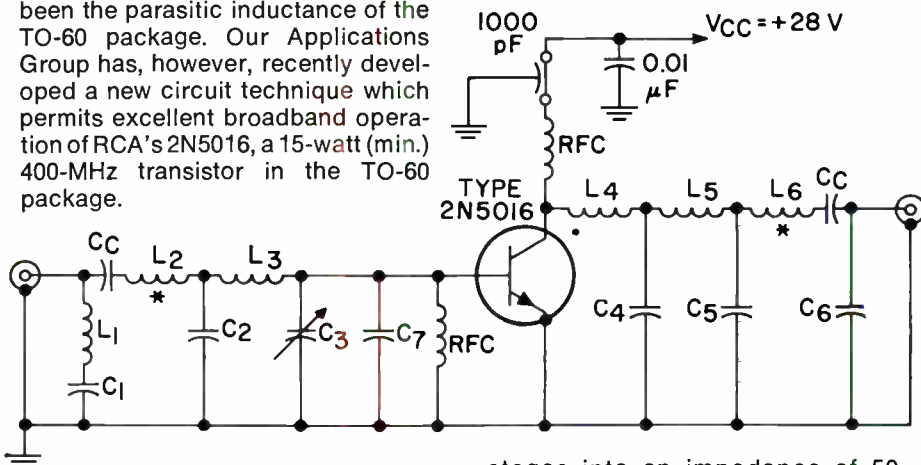

This design uses a lumped-constant reactive ladder network to provide the required input impedance matching. Basically, this circuit first tunes out the parasitic inductance values by making them appear resistive. Then this "resistance" is transformed by the input L-C circuit

stages into an impedance of 50 ohms. With the inductance thus tuned out, broadbanding becomes possible.

This approach is shown schematically in a 225-400 MHz power amplifier which provides 16 watts plus or minus 1 dB with an input of 6 watts. Circle Reader Service No. 513.

devices. RCA's new developmental TA7016 family has changed all that. Six transistors in all, this family uses the standard TO-3 form factor with all its obvious advantages of size and cost. Only the leads have been modified to handle the high currents involved. Inside the case, we've put a 380-mil-square Hometaxial-base pellet, one of the largest ever for power transistors.



The word "super" really takes on meaning when you examine the spec's for the TA7016. It has a peak collector current of 100 A. Dissipation is 300 watts at 25°C with a V_{CEX} (sus) of 70 volts. The useful beta range is 10-30 at 60 A. And depending upon your mounting requirements, you can choose from three terminal designs: heavy pin, soldering lugs, or flexible leads with solderless connectors. It all adds up to a new circuit cost savings for inverters, regulators, controls, and other linear and switching power applications. Circle Reader Service No. 515.

New IR Emitter Has "Mini" Shape but "Maxi" Performance

RCA's 40598 gallium-arsenide emitter is one of the world's smallest infrared sources, but everything about its performance is big. This new optical device features a power output of 0.3 mW at 50 mA operating current, making it compatible with inexpensive IC drivers. The unique lens design uses a miniature reflector system to focus radiation into a 15° half-angle cone of high radiant intensity. Its 9100 Å emission can be readily sensed by conventional silicon photodetectors. Another important highlight is room temperature operation; it is rated for -73° to +75°C performance.

RCA's 40598 is a reliable and economical substitute to perform the function of tungsten light bulbs in card readers. Other operations include shaft encoders, isolated switching circuits and intrusion or

burglar alarms. Circle Reader Service No. 514.

The "Super" TO-3 Power Transistor—100 A and 300 W

Up to now, industrial equipment designers requiring high-power, high-current transistors had to rely on expensive, space-consuming stud

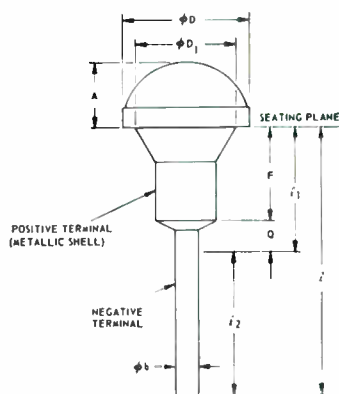

See your RCA Representative for full information on all products shown. Ask your RCA Distributor for his price and delivery. Or write RCA Electronic Components, Commercial Engineering, Section Q-N-7-1, Harrison, N. J. 07029 for specific data sheets.

RCA

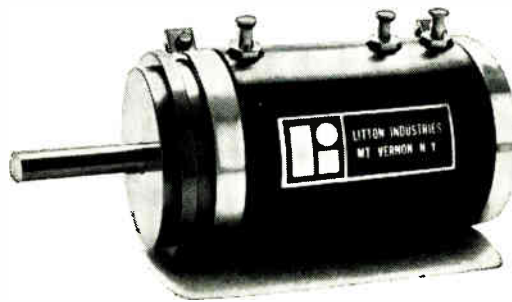

The penny-pincher.

Something new is cooking in our pots. Litton, always associated with high prices, tight tolerances, and state of the art conformities, is broadening its line to include a new series of low-priced potentiometers. First to be introduced is our LD09 $\frac{7}{8}$ " diameter 10 turn.

Don't let the low price fool you. The LD09, like all our other wirewound potentiometers, is designed to meet all the stringent requirements of Mil-R-12934 and is recommended for practically all applications, military and space included. No shortcuts or compromises in Quality Control or Reliability. All we are doing is combining a unique new design approach with our excellent manufacturing capabilities.

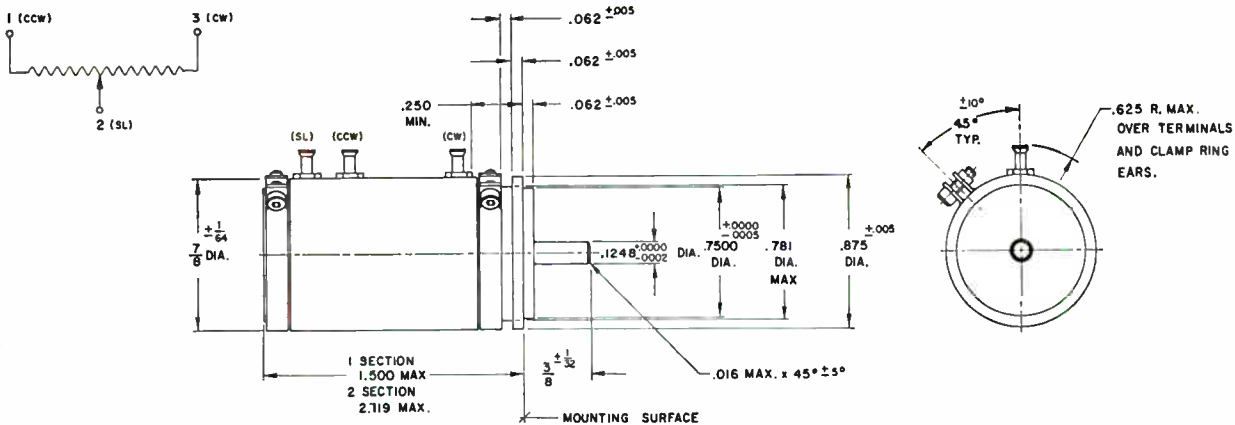

ELECTRICAL

Total resistance range	100 Ω to 150K
Total resistance tolerance	$\pm 3\%$
Resistance—temperature coefficient	± 50 PPM / $^\circ$ C.
Linearity standard	$\pm 0.2\%$ independent
End voltage	0.5% max.
Resolution	Within linearity tolerance
Electrical travel	3600° +10° -0°
Phasing (2 section only)	CCW taps aligned $\pm 1^\circ$
Noise	100 Ω max.
Power rating	2.0 watts @ +85°C
Insulation resistance	1000 meg. Ω min.
Dielectric strength	1000 VRMS, 60 CPS
Temperature range	-55° C to +150°C
Additional taps	Available as special

MECHANICAL

Mounting type	Servo or bushing
No. of sections	Single or dual
Bearing type	Stainless steel ball bearings
Servo mount	Sleeve bearings
Bushing mount	.001 max. TIR
Lateral runout	.001 max. TIR
Pilot surface-runout	.001 max. TIR
Shaft runout	.001 max. TIR
Radial play	.002 max. TIR
End play	.001 to .004
Starting torque (oz. in. max.)	1 section 0.4 2 section 0.7
Servo mount	0.5 0.8
Bushing mount	
Stop torque	48 oz. in. min.
Mechanical travel	3600° +10° -0°

CONSTRUCTION

Housing	Thermo-setting high density plastic
Mounting	Anodized aluminum
Shaft	Stainless steel passivated

To get the ball rolling, we are offering the single-section servo mount model LD09 in any of the following resistances, with an independent linearity of $\pm 0.1\%$: 1K, 2K, 5K, 10K, 20K, 50K, and 100K. The price in quantities of 1—9: \$19.95 each. (We'd be happy to talk about larger quantities, of course.)

If you require a non-linear function, output load compensation, tighter linearity tolerance, additional taps, or special mechanical travel—don't fret. This versatile device has been designed to meet your special needs at only slightly higher costs. Simply let us know your special requirements, and we'll respond—at once, and competitively.

Litton Industries Potentiometer Division 226 East Third Street, Mt. Vernon, N.Y. 10550	P.O. Number _____
Please enter our order for _____ units of Litton Model LD09 (Single Section Servo Mount) @ \$19.95 per unit. Please allow 3 to 4 weeks for delivery. I understand that Litton will make its best effort to meet said delivery requirement, and that this order will be subject to Litton's standard terms and conditions of sale.	
My total resistance requirements are as follows:	
<input type="checkbox"/> 1K <input type="checkbox"/> 2K <input type="checkbox"/> 5K <input type="checkbox"/> 10K <input type="checkbox"/> 20K <input type="checkbox"/> 50K <input type="checkbox"/> 100K	
<input type="checkbox"/> I'd rather see your salesman. And ask him to bring a catalog.	
Name _____	
Company _____	
Address _____	
City _____ State _____ Zip _____	

5 things you should know

3. More than a switch:

Most double-diffused power transistors can only be used for switching applications. But, Fairchild power transistors have extremely high power dissipation. That means they can also be used as amplifiers. (Servo-amps, power amps, class B push-pull amps, etc.) They also make good switches.

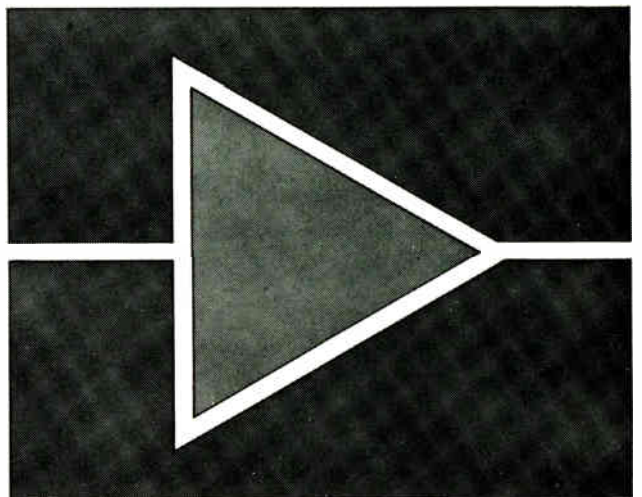

1. The discrete emitter:

Fairchild has improved beta linearity characteristics of power transistors. We chopped the emitter into many small discrete emitters connected in parallel by buss bar metalization. As a result, the increased emitter-base peripheral area raises emitter injection efficiency.

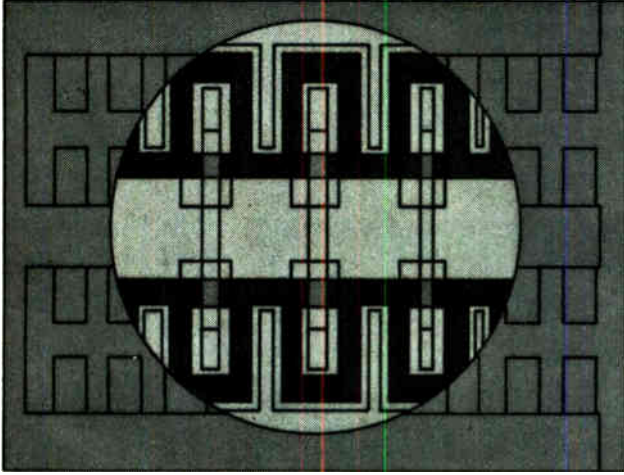

2. Integrated feedback resistors:

We also increased the safe area of operation. With a built-in safety fuse. Each discrete emitter is connected to the buss bar through a deposited thin film nickel-chromium resistor. That keeps the current flow under control and increases the device's second breakdown capability. If any emitter overheats, its resistor will open. Fairchild power transistors will perform without detectable degradation with up to 10% of the emitter sites opened.

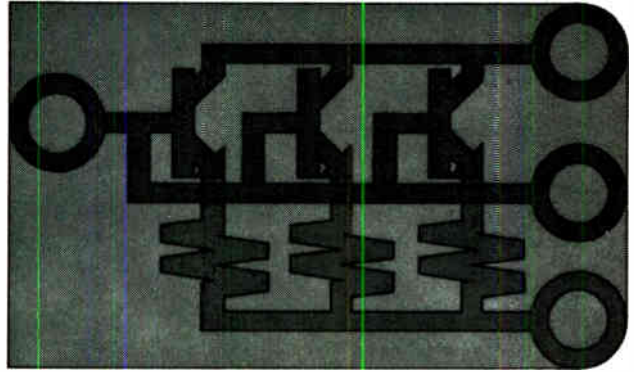

about silicon power transistors:

4. Planar II:

Several manufacturers use the Planar* process to make power transistors. But, not the way we do. (That's why other power transistors are limited to switching functions.) So, if you're a circuit designer, you don't have to put up with the low reliability and poor frequency response of Mesa designs. Fairchild offers reliable, 100%-tested epitaxial Planar power transistors with high frequency response. And, with all the advantages Fairchild power transistors offer, they cost only a little more than Mesa.

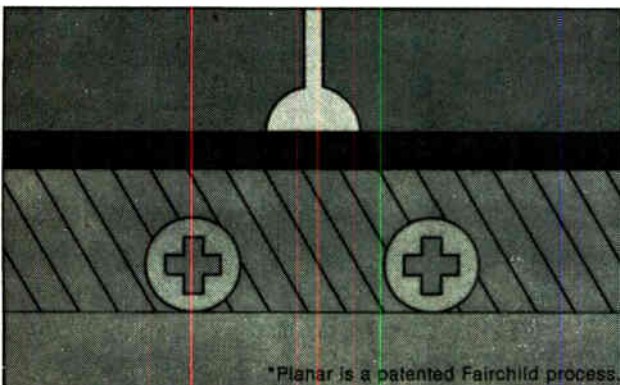

5. Power source:

You can get power transistors from your local Fairchild distributor. He's got NPNs and PNPs. Amplifiers and switches. Simply circle the Reader Service Number below for complete specifications and applications information.

Fairchild Semiconductor, A Division of Fairchild Camera and Instrument Corporation, 313 Fairchild Drive, Mountain View, California 94040
(415) 962-5011 TWX: 910-379-6435

FAIRCHILD
SEMICONDUCTOR

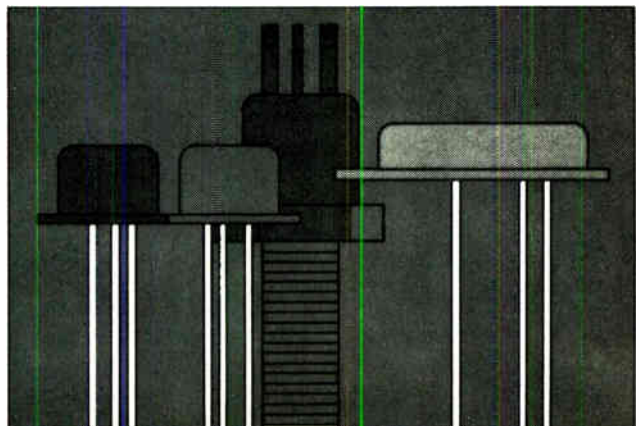

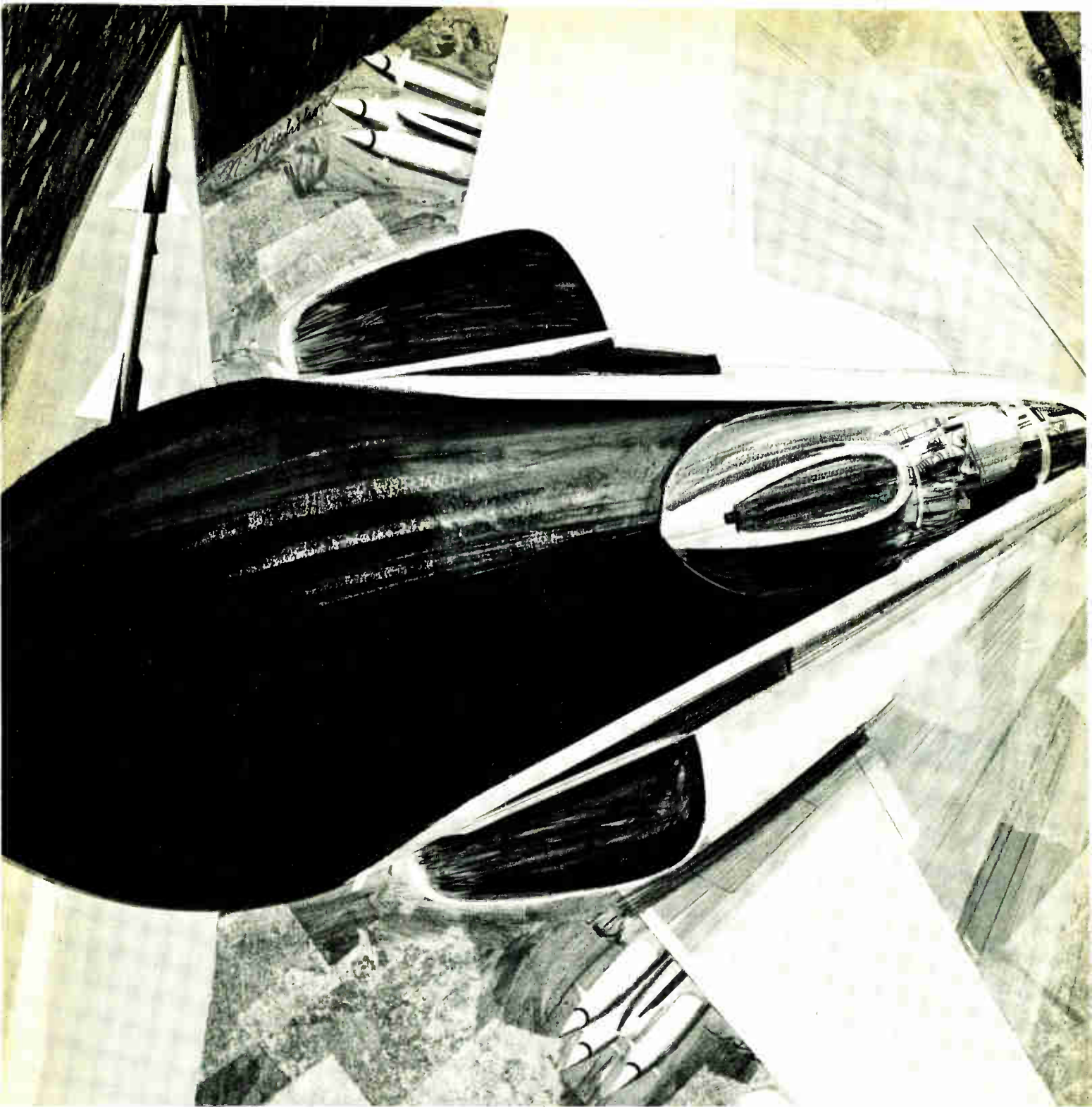

Quick reaction

It means different things. To the pilot, it may be a violent maneuver to dodge an enemy missile. To the systems contractor, it means getting operational gear designed and built and delivered in a hurry.

Working with QRC contractors, MEC has developed TWTs and solid-state microwave acoustic delay lines for signal repeating, augmentation, microwave memory, direction finding, communications and target simulation systems. And all were built to perform in hostile environments.

If you're designing a quick reaction system, contact MEC. We have a reputation for "turning it on" and reacting quickly.

You can learn more by calling the men from MEC.



Microwave Electronics
A TELEDYNE COMPANY

3165 Porter Drive, Palo Alto, Calif. 94304

Circle 220 on reader service card

Japan

Exposure by IC

So far, camera makers have stuck to galvanometers for the indicators in exposure meters. But a challenge to the galvanometer's domination may be in the offing from the integrated circuit.

The Yashica Co., one of the major Japanese camera producers, is showing the way. Last month, the company started selling in its home market for \$60 a 35-mm camera with IC-controlled indicator lamps to show when the shutter speed and aperture setting are right for the light available and the film speed. The camera, the Yashica Lynx 5000E, sells for about \$2 more than a similar model with a conventional meter. If the IC camera catches on, Yashica may find its competition sincerely flattering.

Lights out. In the 5000E, the exposure indicator is mounted inside the viewfinder. When the user wants to check his settings, he pushes a button that switches two 1.3-volt batteries onto the IC-lamp circuit. If the speed and aperture settings would cause an overexposure or an underexposure, "Over" or "Under" lights up in the viewfinder. When the settings are right, out goes the light.

Each lamp is controlled by a pair of transistors on the IC, a thick-chip hybrid made by the Nippon Electric Co. In addition to the four transistors, the IC has six resistors and two thermistors. Off the IC, but in the lamp circuit, is a small resistance ring through which the film speed, shutter speed, and aperture settings are fed to the circuit.

Cell mates. The ring works with a cadmium sulfide cell, whose resistance goes down as the light falling upon it becomes brighter. If there's too much light for the

camera settings, the ring's resistance is higher than the cell's. This condition turns on the first-stage transistor in both the Under and Over sides of the circuit. These two transistors are pnp types. So is the second-stage transistor on the Under side, and it is held off when its mate is on. But the second-stage Over transistor, an npn type, turns on and lights the overexposure lamp.

If there's too little light, the resistance of the CdS cell is higher than that of the resistance ring, and neither first-stage transistor can turn on. In that case, the second-stage pnp Under transistor and its associated indicator lamp switch on.

When all's right, the resistance ring and the CdS cell balance. In this case, the first-stage pnp Under transistor switches on, holding off the second-stage pnp transistor. The first-stage pnp Over transistor, however, cannot switch on because its emitter resistance is higher than that of its Under counterpart. Neither lamp, then, can be switched on.

Great Britain

Blinking at IC's

More than a decade ago, researchers found they could get a better look at integrated circuits by applying small steady voltages to them and viewing them with a scanning electron microscope. A difference of even 1 volt between two small areas, ordinarily look-alikes, results in substantial contrast on a micrograph.

Trouble is, most IC's work with fast-changing voltages. So studying them with a steady voltage doesn't show what goes on during high-frequency operation. What's needed is a stroboscopic technique, one that keeps the electron-beam illu-

mination of the microscope in step with the varying voltage applied to the IC.

Two British researchers, Graham Plows and William Nixon, will tell this week how they've managed to take strobed micrographs. Plows and Nixon, of the engineering department of Cambridge University, will be addressing a Cambridge scanning-microscopy conference sponsored by the Institute of Physics and the Physical Society.

Gated. Like a sampling oscilloscope, the scanning microscope used in the Cambridge technique looks at only a small part of the applied waveform. A 7-megahertz, 5-volt peak-to-peak distorted sine wave is applied to the IC. At the same time, the microscope's main electronic beam is pulsed at a 7-Mhz repetition rate with pulses 10 nanoseconds long. The video circuit in the microscope is gated on just before each pulse is applied.

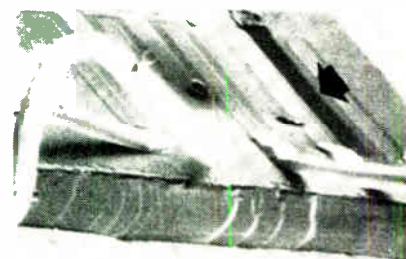
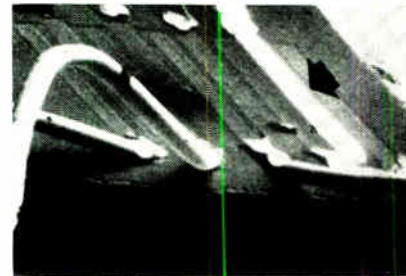

Conspicuous. At the start of the 7-Mhz applied voltage cycle, energized gate (arrow at top) is at its most negative potential and appears as brightest spot on MOS circuit. A half-cycle later (below), the gate is at its positive peak and becomes the darkest part of the circuit. The gate is about 25 microns wide.

Except for the short bursts, the device operates the same way as a conventional scanning microscope: The main electron beam scans the surface of the specimen being viewed, provoking an electron emission. This emitted charge is collected and amplified to obtain a video signal that modulates the brightness of a cathode-ray tube scanned in synchronization with the main beam.

Because the collector that picks up the specimen's emission is sensitive to voltage variations, a correction is needed when the specimen has a varying voltage applied to it. Otherwise, the video signal applied to the crt would result in a meaningless image. Plows and Nixon use a special filter network to maintain a linear relationship between the applied voltage and video signal.

Computer quiz

Cost alone dictates that it will be a long time—if ever—before computers will take over from the overworked teachers in British classrooms. And even when the price is right, there'll still be those who insist that the teachers should be human.

Among the proponents of human teaching, paradoxically, is the educational adviser to International Computers Ltd., Peter Lambert. He sees the computer as a teacher's aide, largely to test students individually after a lesson. Lambert has devised a system to do this, and it's scheduled to be operating in a Sussex school toward the end of the year.

Birds and bees. The system links keyboard units having cathode-ray-tube displays to a 1903 computer in the company's headquarters. At the outset, the computer's subject will be biology—as told to 11- and 12-year-olds. Later, other subjects and perhaps other schools will be included in the system, which Lambert thinks is Britain's first computer-aided teaching in a school.

With Lambert's setup, the children first go through a lesson under the guidance of a teacher. When the child thinks he knows

the material, he goes to a keyboard unit and types in his name and his file number. This connects him to a file in the computer memory that holds his record for the subject. Thus, the computer knows how to quiz him.

Q. & A. A "hello" is flashed on the screen before the first question. The computer then analyzes the key words in the pupil's answers to decide if they're right or wrong.

As the quiz goes on, the computer sorts out any wrong answers, and from them figures out where the pupil is confused. At any rate, Lambert expects that to happen most of the time. If the computer can't cope with a series of answers, it will tell the child to go see the teacher.

The child's answers and his progress from wrong to right ones are stored in his computer file. The teacher can call them back up on the display if he wants to review a pupil's work.

The Netherlands

Philips unveils computer

Speculation about the activities of Philips' Gloeilampenfabrieken's computer division, established in 1962, ended abruptly last month when the company announced that it has developed a trio of third-generation computers and will start deliveries in 1969. The Dutch post office will get the first [Electronics, June 10, p. 261].

Peers. Philips, the largest electronics company based outside the U.S., calls its line the P1000 series. Each of the three basic models has a rough counterpart in the International Business Machines Corp.'s 360 series, the best seller among third-generation machines.

Philips' P1100, for example, has an add time of 21.5 microseconds, a memory cycle time of 1 microsecond, and a monthly rental starting at \$5,700, characteristics that put it in the same class as the IBM 360/30, which adds in 39 μ sec, has a memory cycle time of 1.5

μ sec, and rents at \$2,700 or more per month.

Next up in size is the P1200, a competitor to the IBM 360/40. The Dutch computer has an add time of 7 μ sec and a memory cycle time of 1 μ sec. Comparable figures for the IBM machine are 11.88 μ sec and 1.75 μ sec.

Largest of the Philips machines is the P1400, which the company describes as a counterpart of the IBM 360/50. Its add time is 2.5 μ sec and its memory cycle 1 μ sec, making it slightly faster than the 360/50. Monthly rental for the most extensive P1400 version is \$57,000.

Building blocks. Philips claims a real advance for the P1000 internal core store, which ranges from 16,000 octads for the smallest machine up to 512,000 octads for the largest. All have a 1 μ sec cycle time.

Internal stores for the P1200 and P1400 can be expanded considerably. Up to seven core-memory modules can be added, each with a capacity of 2 million octads. Cycle time for these modules is 2.5 μ sec.

These memories are paired with programs that insure store protection. And, like the memories, the programs can be built of modules that can be handled in the working store. As many as 16 programs can be handled at the same time by the central processor.

Programs, of course, are compatible among the large and small P1000-series machines. Philips has developed its own programming language, but there are also programs for such standard languages as Algol, Cobol, and Fortran. And to arm its maintenance people, Philips has had its computer designers prepare trouble shooting programs.

Canada

Fixed positions

Budget-watchers at Canada's Hydrographic Service are expecting some good news soon. A new low-cost system for positioning vessels



In on the plot. Canadian hydrographic survey system puts loudspeaker and walkie-talkie on mother ship, special receiving equipment on side vessel.

following precise parallel courses during charting surveys will get a full-fledged tryout this summer, and everyone believes it will be a success.

If they're right, it will mean substantial savings for hydrographic surveys. Instead of conventional \$15,000 position-keeping receivers, most survey vessels would get equipment costing about \$1,000. A mother ship carrying the expensive receiver would guide up to a half-dozen other vessels.

The idea of taking soundings by ships in parallel courses has also been tried out by the Swedes [Electronics, Dec. 25, 1967, p. 164]. But their hardware is considerably more sophisticated—and more expensive. The Swedish equipment costs \$60,000 and keeps nine ships on station. The Canadians could handle seven vessels with hardware costing about \$20,000. However, the Canadian gear is still experimental, while the Swedes have theirs in production.

Over and under. Walter Wyslouzil, who developed the station-keeping system at Canada's National Research Council (NRC) points out two major differences between the Swedish and Canadian versions. Though both are based on the dif-

ference in speed between radio and sound waves, the Canadians use overwater sonics and the Swedes use underwater ultrasonics. And the Canadian system has no delay in the radio signal.

NRC avoided the need for a delay line by using the radio signal to trigger the position indicator on each side vessel. The signal releases a recording arm that sweeps across a 3-inch band of conductive paper in 1 second. When the slower sound pulse arrives, it causes a pin on the rotating arm to burn a mark on the paper to indicate the distance from the mother ship. A full 3-inch sweep across the paper corresponds to a distance of 200 feet; the start of the sweep, though, can be set to represent any distance from 200 to 900 feet.

Bullhorn. Audio-tone bursts, at 2,000 hertz, are beamed to the side vessels from the mother ship's loudspeaker at 1.2-second intervals. The 30-watt driver for the loudspeaker gives the system a range of 1,000 feet. An ordinary walkie-talkie alongside the loudspeaker transmits the radio signal. With this arrangement, there's no need for special circuits to synchronize the two signals.

Because the sound wave travels overwater, the NRC system needs a

correction for winds and variations in air temperature. The receiver is calibrated for zero-correction readings at 20°C and no wind. As long as air temperature is measured to within 1°C and wind gauged with an accuracy of 10 miles per hour, the corrected readings are within 17 feet of the true distance between the mother ship and the side vessel.

West Germany

Moving up on IBM

All things considered, Siemens AG is West Germany's top electronics producer. But when it comes to computers, the company runs a poor second in its home market to the International Business Machines Corp.

When you're Number Two, everybody knows, you try harder. And that's what Siemens is doing in computers. Early last year, the company acquired a majority holding in Zuse KG, a veteran German manufacturer of data processing equipment. Series production of computers has just started at a plant at Augsburg, the company's second for business machines. Sales bases are appearing all over Western Europe, and capital spending in the data processing field will continue unabated at an annual average of \$75 million for at least two more years.

Outdistanced. Siemens, though, doesn't expect to displace IBM from the Number One spot. IBM's lead is so great that the company will remain unchallenged for quite some time. In dollar value of computers installed or on order, the U.S. firm has gobbled up almost two-thirds of the German market—six times more than Siemens can claim.

Siemens' goal is to keep its position in the world's second largest computer market and to stay on the inside track in the race for a larger share of the expanding West European market. By 1975, industry observers predict, there'll be 11,500 computers installed in West Germany alone, three times the

number at the beginning of this year.

Good growth. Siemens is a Johnny-come-lately in computers, but is now doing nicely. Since its start in 1957, the company has been gaining ground steadily, overtaking such computer heavyweights as the Univac division of the Sperry Rand Corp. and Bull-GE. With more than 400 machines, worth \$185 million, ordered or installed in West Germany as of last month, Siemens can claim just under 11% of its market, twice the share it had three years ago. Siemens predicts its computer sales in fiscal 1968, ending in September, at \$100 million, including exports. That's six times more than in fiscal '66.

Expansion like that, Siemens concedes, can't be expected to keep on forever. Still, annual growth of 20% is expected for at least another half-decade. And no significant letdown is predicted for the following five years.

Most of the push is coming from the company's System 4004, built under license from RCA. The 4004, largest in the Siemens lineup of commercial machines, is a version of RCA's Spectra 70, but it's becoming more and more a home-made product; the proportion of RCA hardware has fallen from two-thirds to a half. Take software into account, and the RCA share of an installation falls to about one-quarter. Siemens' goal is to increase the share of German-made hardware in the 4004 to 70%.

Under control. Though only second in Germany's business-computer market, Siemens is far and away the leader in process control. Of the 120 process computers installed in Germany at the end of last year, 80 carried the Siemens label.

The company figures that of the 900 process control computers expected to be in operation in Germany by the end of 1972, 500 will be Siemens-made. This fast-growing market is the target of the firm's System 500, introduced in late 1966, which consists of four compatible machines, costing an average of \$200,000 each.

Still another area in which Sie-

mens stands out is traffic-control computers, for which the company has just booked its 32nd order. Its two traffic-control machines, the VSR 16000 and VSR 3000, are best sellers in Europe. Seventeen systems, all of the more powerful VSR 16000 type, have already been installed in German cities, Helsinki, and Vienna. Eight more are about to be delivered.

Despite these successes, Siemens' capital spending for computer operations is still running ahead of sales and rental income. So far, Siemens has invested \$150 million in its computer ventures, but it will be another two years or so before the company's data processing division will start showing a profit. By then, Siemens will have spent about \$300 million on computers.

France

CSF trims down

Last year, Paul Richard had little exposure to electronics but a reputation in French board rooms as a wizard in straightening out tottering companies. This year, the electronics knowledge is still relatively slight, but the reputation is more glittering than ever.

Richard is the vice chairman of Compagnie Française Thomson Houston-Hotchkiss Brandt who moved over to CSF-Compagnie Générale de Télégraphie sans Fil last year almost on the day Thomson-Brandt announced its plan to take over CSF. Richard was assuming control of a company that had lost \$27 million in 1966 on sales of \$293 million. He did his job quickly and well; last year CSF showed a profit of \$17.3 million on sales of \$317 million.

Against itself. A big factor in the turnaround was the selling off of deficit-ridden subsidiaries. This is still going on, and when the takeover becomes fully effective in September—a year after Thomson-Brandt picked up a 46% holding—CSF will have lopped off many

more losing operations than most industry observers expected.

First to go was the company's only important production venture in the U.S., Warnecke Electron Tubes Inc. CSF sold its interest to the Northrop Corp. After that went a good chunk of CSF manufacturing operations in Africa—notably Algeria, Chad, Cameroon, and the Malagasy Republic. Then went a minority holding in Bull-GE and part of CSF's small share in the Compagnie des Compteurs. In both cases, CSF had been in a sense competing against itself; it has affiliates that produce computers, as does Bull-GE, and industrial control equipment, as does Compteurs.

And most recently, the company's vast administrative operations have been consolidated at Rocquencourt, near Versailles. Even the former headquarters in Paris, kept as a meetings center, has now been sold.

Encore? But Richard will be hard put to turn the trick again this year. Like all companies with heavy military orders, CSF has dismal short-term prospects now that President de Gaulle's defense-hardware budget may be under pressure [Electronics, June 24, p. 203]. Thomson-Brandt, for its part, was harder-hit by the strikes than most. Some of its workers stayed out until late June.

Richard, then, will face a double setback when the takeover becomes official and he's running Thomson-CSF, which, as a division of Thomson-Brandt, will lump together all nonconsumer electronics operations.

Around the world

Soviet Union. A computer has found gold in Siberia. Yuri Zhuravlev of the Soviet Academy of Sciences reports that several deposits were located by using a computer program that assesses geological data obtained by electronic exploration.

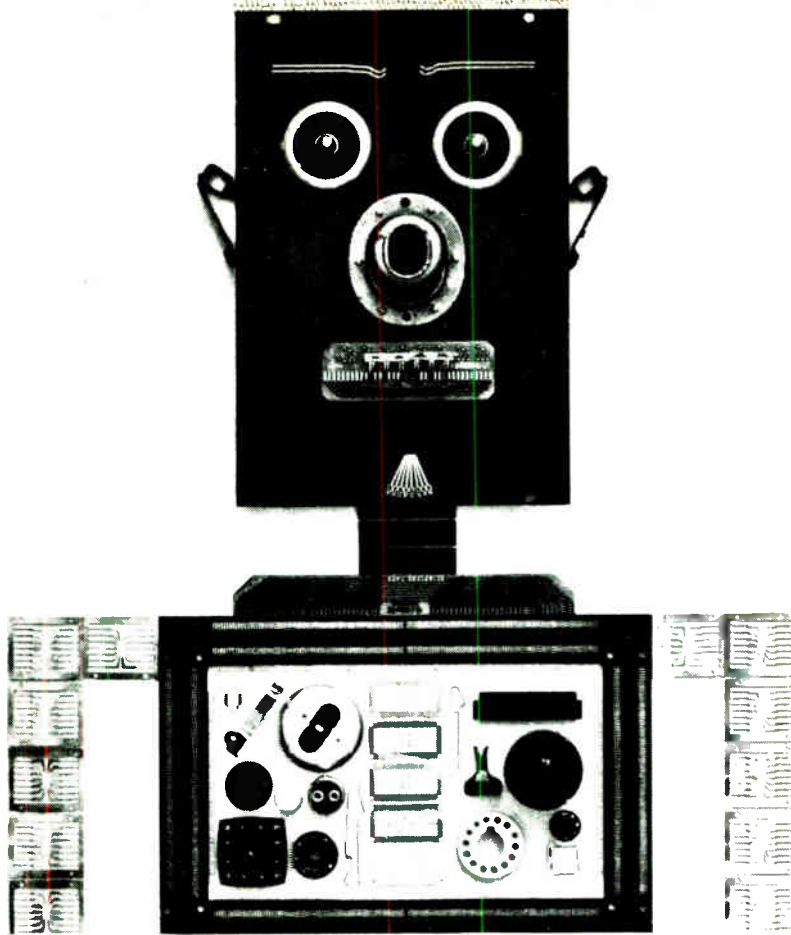

Sylvanians do as they're told.

Our living depends on it.

We turn out 50 million custom-fabricated parts a day. To exact specifications.

Including precision stamping of high-tolerance, miniature metal shapes.

Precision molding of intricate plastics parts.

Precision forming of wire for critical electronics.

Combining metals, plastics and wire into precision-built assemblies.

We live by our accuracy. After all, if we don't do what we're told, you

may not tell us anymore.

We've been doing it for over 17 years. On transistor leads, computer memory core frames, connectors, pen caps, aerosol spray tips, razor blade dispensers, integrated circuit frames. You name it.

We've got nine plants, the most advanced equipment, and the best engineers and die makers around to do it.

And we'll even help you design the part. Then we'll build the dies, produce the parts, and do the assembly. Exactly as we're told.

That means you get the parts you want, the way you want them, when you want them—probably at less cost than you could do it for yourself.

So the next time you need a custom fabricated part, call a Sylvanian and tell him what to do.

Sylvania Metals & Chemicals, Parts Division, Warren, Pa. 16365.

CUSTOM PARTS BY
SYLVANIA
A DIVISION OF
GENERAL TELEPHONE & ELECTRONICS

Electronics advertisers

July 8, 1968

■ Acopian Corporation Mort Barish Associates	121	Datacraft Corp. Advertising Art Services	26	■ Hewlett-Packard, Loveland Div. Tallant/Yates Adv., Inc.	2, 63
Acromag Inc. Watkins-Rogers, Inc.	200	Delta Design, Inc. Pacific Publications	66	■ Hewlett-Packard, Microwave Div. Lennen & Newell, Inc.	167
□ AEG-Telefunken Werbungs-Makler	OAS-6	Delta Products, Inc. Noble De Roïn & Associates	7	■ Hewlett-Packard, Moseley Div. Lennen & Newell, Inc.	1
Airco Speer Electronic Components Hazard Adv. Co., Inc.	47	Di-Arco Corp., Div. of Houdaille Industries, Inc. Charles E. Brown Adv. Agcy.	162	■ Hewlett-Packard, Palo Alto Div. Lennen & Newell, Inc.	146
Allen-Bradley Co. Fensholt Adv. Agcy.	40, 41	Dialight Corp. Michel Cather, Inc.	200, 201	HI-G, Inc. Marketing Assistance, Inc.	169
American Electronics, Inc. Alden Adv. of California, Inc.	188	Dow Chemical Co., The MacManus, John & Adams, Inc.	151	Hitachi Metals, Ltd. Standard Adv., Inc.	192
American Lava Corp., Sub. of Minnesota Mining & Mfg. Co.	101	Dow Corning Corp., Engineering Products Div. Church & Guisewite Adv.	189	■ Honeywell, Test Instruments Div. Campbell Mithun, Inc.	118
■ AMP, Inc.	28, 29	□ Dow Corning Int'l., Ltd. Marsteller Belgium, S. A.	OAS-9	Industrial Electronic Engineers Van Der Boom, McCarron, Inc.	180
Amphenol Corp. Marsteller Inc.	155	Duncan Electronics, Inc., Sub. of Systron-Donner Corp. Helme Associates, Inc.	196	Intellux, Inc. Palmer/Larson Communications	207
Andrew Corp. Fensholt Adv. Agcy.	72	DuPont de Nemours Co., Industrial Fibers Nomex Batten, Barton, Durstine & Osborn, Inc.	153	■ Int'l. Crystal Mfg. Co. Robert V. Freeland & Associates	204
Arnold Engineering Co. Buchen Adv., Inc.	18, 19	□ Dynamco, Ltd. Leslie Ingham Associates, Ltd.	OAS-17	I R C, Inc. Gray & Rogers, Inc.	44, 45
□ Ates Componenti Elettronici, S. P. A.	OAS-14	Eastern Shopping Centers, Inc. Miller Adv. Agcy., Inc.	188	■ ITT Cannon Electric MacManus, John & Adams, Inc.	213
■ Beckman Instruments, Inc., Helipot Div. Hixson & Jorgensen, Inc.	78	Eastman Kodak Co., Business Systems Markets Div. J. Walter Thompson Co.	183	Johnson Co., E. F. Midland Associates	205
Belden Corp. Fensholt Adv. Agcy.	12, 13	E G & G, Inc. Culver Adv., Inc.	120, 199	■ Kepco, Inc. Weiss Adv.	210
Bell Telephone Laboratories N. W. Ayer & Son, Inc.	134	E-H Research Laboratories, Inc. Steedman, Cooper and Busse Adv.	61	LectroMagnetics, Inc. Van Der Boom, McCarron, Inc.	198
Binary Electronics of California	182	■ Electrical Industries Douglas Turner, Inc.	156	■ Ledex, Inc., Bramco Controls Div. Yeck & Yeck, Inc.	124
Bourns Inc., Trimpot Div. Lester Co., The	194	Emerson & Cuming, Inc. Edwin F. Hall	132	Litton Industries, Inc., Potentiometer Div. MacManus, John & Adams, Inc.	216, 217
■ Brush Instruments Div. of Clevite Corp. Carr Liggett Adv., Inc.	179	Fairchild Semiconductor, Inc. 10, 11, 70, 71, 140, 141, 218, 219 Faust/Day, Inc.	217	Litton Industries, Inc., Winchester Electronics Div. MacManus, John & Adams, Inc.	148, 149
■ Bulova Watch Co., Electronics Div. Levy Adv. Assoc.	131	Fansteel Metallurgical Corp. Reincke, Meyer & Finn, Inc.	177	Lockheed Electronics Co. McCann-Erickson, Inc.	133
Bunker-Ramo Co. Diener & Dorskind, Inc.	176	Fluke Mfg. Co., John Bonfield Associates	17	General Cable Corp. Hicks & Greist, Inc.	144, 145, 168
■ Bussmann Mfg. Div. of McGraw Edison Co. Henderson Adv. Co.	202, 203	General Electric Co., Capacitor Div. Robert S. Cragin, Inc.	102, 103	■ Machlett Laboratories, Div. of Raytheon Co. Fuller & Smith & Ross, Inc.	15
Cambridge Thermionic Corp. Chirurg & Cairns, Inc.	126	■ General Electric Co., Electronic Components Sales Operation Robert S. Cragin, Inc.	68, 69	■ Magnetics, Inc. Lando Adv. Agcy., Inc.	171
Celanese Plastics Co., Div. of Celanese Corp. MacManus, John & Adams, Inc.	142, 143	■ General Electric Co., Instrument Dept. Robert S. Cragin, Inc.	22, 23	□ Marconi Co. Ltd., Line Edition Comm.: Mars Hampshire House, Ltd.	OAS-15
Centralab Div. of Globe-Union, Inc. Brady Co., The	184	■ General Electric Co., Lamp Glass Dept. Dix & Eaton, Inc.	137	□ Marconi Radio Communication Hampshire House, Ltd.	OAS-8
■ Chery Electrical Products Corp. K & A, Inc.	175	■ General Electric Co., Lamp Metals & Components Div. Dix & Eaton, Inc.	207	■ Merkel & Sons, L. Frank George Moll Adv., Inc.	125
Cinch Graphik Div. of United Carr Fastener Co. Reach McClinton & Co.	24	■ General Electric Co., Specialty Control Div. Robert S. Cragin, Inc.	114	■ Micro Switch, Div. of Honeywell Batten, Barton, Durstine & Osborn, Inc.	42, 43
Clarostat Mfg. Co. Horton, Church & Goff, Inc.	158	General Radio Co. Horton, Church & Goff, Inc.	2nd Cover	Microwave Associates, Inc. Kalb & Schneider, Inc.	172
■ Clevite Corp., Piezoelectric Div. Carr Liggett Adv., Inc.	207	□ Globe-Union, Inc., Int'l. Div. Brady Co., The	OAS-10	■ Microwave Electronics Corp., Sub. of Teledyne Bonfield Associates	220
■ Clifton Precision Products Co., Div. of Litton Industries Ivey Adv., Inc.	32	Gries Reproducer Co. Harold Marshall Adv.	180	■ Mitsumi Electric Co., Ltd. Sanko Tsushinsha, Ltd.	182
■ CML, Div. of Tenny Engineering Co. Keyes, Martin & Co.	205	Heath Co., Sub of Schlumberger, Ltd. Advance Adv. Service	116, 117	Motorola Semiconductor Products, Inc. Lane & Bird Adv., Inc.	65, 76, 77
Communication Electronics, Inc. William C. Estler-Public Relations	170	Heinemann Electric Co. Thomas R. Sundheim, Inc.	6	Mullard, Ltd. Parker-Rumrill Int'l., Inc.	228
Control Products Div., Consolidated Electrodynamics Corp., A Bell & Howell Co. Porter & Mills Adv.	152	■ Hewlett-Packard, Colorado Springs Div. Tallant/Yates Adv., Inc.	3rd Cover	National Accelerator Laboratory Connor-Sager Associates, Inc.	181
Corning Glass Works, Electronics Div.—Capacitors Rumrill-Hoyt Co., Inc.	67	■ National Electronics, Inc. Connor-Sager Associates, Inc.	190		
Corning Glass Works, Electronics Div.—Resistors Rumrill-Hoyt Co., Inc.	119				
■ Cosmocar Optical Co., Ltd. Matsushita, Inc.	202				
■ Couch Ordnance Inc., Couch Co. Div. Culver Adv., Inc.	130				
CREI, Home Study Div. of the McGraw-Hill Book Co. Henry J. Kaufman & Associates	197				
■ CTS Corp. Burton Browne Adv.	20, 21				

National Semiconductor Corp. Jay Chiat & Associates	113, 115
■ Nippon Coil Co., Ltd. Dai-ichi Int'l., Inc.	192
■ North Atlantic Industries, Inc. Murray Heyert Associates	178
■ Norton Associates, Inc. J. J. Coppo Co.	180
Nus Corp., Electronic Systems Div. Graphic Associates	188

■ Pfizer & Co., Chas., MPM Div. Newmark, Posner & Mitchell, Inc.	206
Phelps Dodge Electronics Products Corp. Smith, Dorian & Burman, Inc.	150
■ Philbrick/Nexus Research Culver Adv., Inc.	59
Philco Ford Corp., Sierra Electronics Operation Hal Lawrence, Inc.	25
□ Philips Eindhoven N. V. T. A. G. De La Mar	OAS-1
■ Photocircuits Corp. Duncan Brooks, Inc.	161
Polaroid Corp. Doyle, Dane, Bernbach, Inc.	55

Radio Corp. of America Al Paul Lefton Co.	4th Cover, 57, 214, 215
□ Rotron Mfg. Co. Lescarbourea Adv., Inc.	OAS-12

Scientific Data Systems Doyle, Dane, Bernbach, Inc.	50
□ Sfernice Publicitor	OAS-16
■ Siemens America Muller, Jordan and Herrick, Inc.	49
Signetics Corp., Sub. of Corning Glass Works Cunningham & Walsh, Inc.	95
■ Siliconix, Inc. Graphics West	127
Sloan Instruments Corp. Palmer/Larson Communications	109
□ Solartron/Schlumberger Electronics Group, Ltd. OAS-2, OAS-3, OAS-4, OAS-5, OAS-13 Southern Adv., Ltd.	
Solitron Devices, Inc., Transistor Div. Haselmire Pearson Adv., Inc.	187
■ Sorensen Operation, Raytheon Co. Urrutia & Hayes, Inc.	75
□ S. P. Electronica Publicitas SPA	OAS-18
Sperry Rand Corp., Sperry Electronic Tube Div. Neals & Hickok, Inc.	164
Sprague Electric Co., The Harry P. Bridge Co.	5, 9
Struthers-Dunn, Inc. Harry P. Bridge Co.	157
Sylvania Electric Products, Inc., Parts Div. Doyle, Dane, Bernbach, Inc.	225
Synthane Corp. Arndt, Preston, Chapin, Lamb & Keen, Inc.	205

■ Technipower S & S Creative Services	154
□ Technique et Produits Ste de Publicite de Films et de Documentaires	OAS-7, OAS-11
■ Tektronix, Inc. Hugh Dwight Adv., Inc.	122
Teledyne Relays Co. S. Michelson Adv.	193
Temescal, Div. of Airco Allen, Dorward & Scroggin, Inc.	174
Tempress Research Co., Inc. Hal Lawrence, Inc.	27
Teradyne, Inc. Quinn & Johnson Adv., Inc.	30
Test Equipment Corp. Dean & Bain Adv., Inc.	186
■ Texas Instruments Incorporated, Components Group Don L. Baxter, Div. of Albert Frank-Guenter Law, Inc.	35, 36, 37, 38, 48



■ Texscan Corp. Burton Browne Adv.	14
Torrington Mfg. Co., Air Moving Div. Wilson, Haight & Welch, Inc.	39
Triplett Electrical Instrument Co. Burton Browne Adv.	163
Trompeter Electronics Jansson Adv.	46
■ Trygon Electronics, Inc. Kameny Associates, Inc.	64
■ Tung-Sol Div., Wagner Electric Corp. Feeley & Wheeler, Inc.	160

Ulano Graphic Arts Supplies, Inc. Lory Roston Associates	139
---	-----

■ Varo, Inc. Tracy-Locke Co., Inc.	8, 182
---------------------------------------	--------

■ Wang Laboratories Impact Adv., Inc.	166
■ Weinschel Engineering Co. E. G. White Adv., Inc.	136
Western Technology, Inc. Jansen Associates, Inc.	16
Williams Gold Refining Co., Inc., Precious Metals Div. Stahlka, Fallor & Klenk, Inc.	138

Classified Advertising

F.J. Eberle, Manager

EMPLOYMENT OPPORTUNITIES	208-209
General Dynamics Electronics Div.	208
EQUIPMENT (Used or Surplus New) For Sale	
A & A Electronics Corp.	209
Goodheart Co., Inc., R. E.	209
Radio Research Instrument Co.	209

■ For more information on complete product line see advertisement in the latest Electronics Buyer's Guide

□ Advertisers in Overseas Advertising Section following Newsletter from Abroad

Electronics Buyers' Guide

George F. Werner, General Manager [212] 971-2310
Ray Smyth, Eastern Regional Manager [212] 971-6538
Robert M. Denmead, Midwest Regional Manager
Regina Hera, Directory Manager [212] 971-2544
Thomas M. Egan, Production Manager [212] 971-3140

Circulation Department

Isaaca Siegel, Manager [212] 971-6057

Research Department

David Strassler, Manager [212] 971-6058
Chloe D. Glover, Research Associate [212] 971-6057

Advertising Sales Staff

Frank E. LeBeau [212] 971-6464
Advertising Sales Manager

Wallis Clarke [212] 971-2187
Assistant to sales manager

Donald J. Austermann [212] 971-3139
Promotion Manager

Warren H. Gardner [215] LO 8-6161
Eastern Advertising Sales Manager

Atlanta, Ga. 30309: Michael H. Miller, 1375
Peachtree St., N.E.
[404] 892-2868

Boston, Mass. 02116: William S. Hodgkinson
McGraw-Hill Building, Copley Square
[617] CO 2-1160

Cleveland, Ohio 44113: William J. Boyle, 55
Public Square, [216] SU 1-7000
New York, N.Y. 10036

500 Fifth Avenue
Donald R. Furth [212] 971-3615
James R. Pierce [212] 971-3616
John A. Garland [212] 971-3617

Philadelphia, Pa. 19103:

Jeffrey M. Preston
Warren H. Gardner,
6 Penn Center Plaza,
[215] LO 8-6161

Pittsburgh, Pa. 15222: Warren H. Gardner,
4 Gateway Center, [412] 391-1314

Rochester, N.Y. 14534: William J. Boyle,
9 Greylock Ridge, Pittsford, N.Y.,
[716] 586-5040

J. Bradley MacKimm [312] MO 4-5800
Midwest Advertising Sales Manager

Chicago, Ill. 60611: Kenneth E. Nicklas
J. Bradley MacKimm, Ralph Hanning,
645 North Michigan Avenue,
[312] MO 4-5800

Dallas, Texas 75201: Richard P. Poole, 1800
Republic National Bank Tower,
[214] RI 7-9721

Houston, Texas 77002: Kenneth George,
2270 Humble Bldg., [713] CA 4-8381
Detroit, Michigan 48226: Ralph Hanning
856 Penobscot Building
[313] 962-1793

Minneapolis, Minn. 55402: J. Bradley
MacKimm, 1104 Northstar Center
[612] 332-7425

St. Louis, Mo. 63105: Robert M. Denmead
The Clayton Tower, 7751 Carondelet Ave.
[314] PA 5-7285

James T. Hauptli [415] DO 2-4600

Western Advertising Sales Manager

Denver, Colo. 80202: Joseph C. Page, David
M. Watson, Tower Bldg., 1700 Broadway
[303] 255-5484

Los Angeles, Calif. 90017: Ian C. Hill,
John G. Zisch, 1125 W. 6th St.,
[213] HU 2-5450

Portland, Ore. 97204: James T. Hauptli,
218 Mohawk Building, 222 S.W. Morrison
Street, Phone [503] 223-5118

San Francisco, Calif. 94111:
James T. Hauptli, 255 California Street,
[415] DO 2-4600

Pierre Braude Tel: 225 85 88: Paris

European Director

Paris: Ken Davey
88-90 Avenue Des Champs-Elysees, Paris 8

United Kingdom and Scandinavia

Brian Bowes Tel. Hyde Park 1451

34 Dover Street,
London W1

Milan: Robert Saidel
1 via Baracchini Phone: 86-90-656

Brussels: F.I.H. Huntjens
27 Rue Ducale Tel: 136503

Frankfurt/Main: Hans Haller
Elsa-Brandstroem Str. 2
Phone: 72 01 81

Geneva: Ken Davey
1, rue du Temple Phone: 31 95 60

Tokyo: Takeji Kinoshita
Shiba, Minato-Ku [502] 0656

Osaka: Ryoji Kobayashi 163, Umegae-cho
Kita-ku [362] 8771

Business Department

Wallace C. Carmichael, Manager
[212] 971-3191

Stephen R. Weiss, Production Manager
[212] 971-2044

Thomas M. Egan,
Assistant Production Manager [212] 971-3140

Dorothy Carmesin, Contracts and Billings
[212] 971-2908

Frances Vallone, Reader Service Manager
[212] 971-2865

Self-contained Gunn effect oscillator generates 5mW from 7V supply...



... part of a range of advanced microwave components

Don't waste time and effort developing cavities for Gunn effect devices. These oscillators, for the next generation of radar equipments, consist of a GaAs device (type 106CXY) fitted in a resonant cavity which is mechanically tuned over the specified range. Other types will have electronic tuning.

Oscillators available are

CL8360 for 8 to 9GHz CL8370 for 9 to 10GHz
CL8380 for 10 to 11GHz CL8390 for 11 to 12GHz

They only need a 7V supply to generate a typical X-band output of 5mW—an obvious advantage over conventional low-powered klystron sources.

Other specialist microwave devices include varactor diodes with resonant frequencies of 9 and 30GHz and high figures of merit. And low noise mixer diodes in small, rugged ceramic and titanium casings with a wide frequency range.

Every designer should have a copy of the Mullard Quick Reference Guide giving information on semiconductor microwave devices. Also ask to be put on the mailing list of the Mullard Bulletin—a regular publication which gives details of new components and applications . . . the result of extensive research and development programs in the Mullard laboratories in England. Mullard employ 1000 qualified scientists and engineers and have six major plants, with over 3 million square feet of floor space.

Write for information on Mullard semiconductor microwave devices, and for the name of your local Distributor.

Mullard Limited, Mullard House, Torrington Place, London WC1, England.

U.S.A. enquiries to Mullard Inc., 100 Finn Court, Farmingdale, Long Island, New York 11735, U.S.A. Telephone: (516) 694-8989 Telex: 961455.

Mullard LIMITED

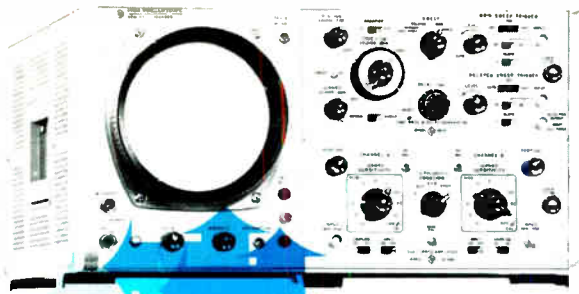

hp's 140 Scope System grows to an 8 x 10-inch display

STAND BACK

take a good look!

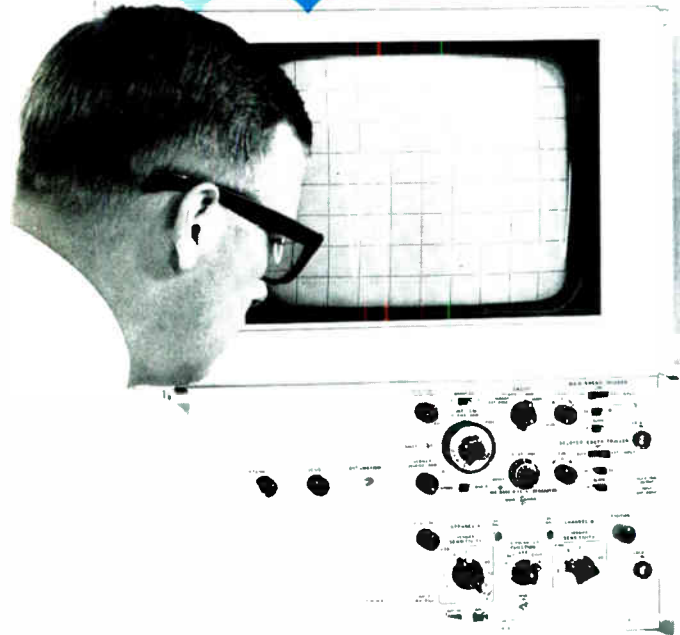

hp 140 Scope System PLUG-IN CAPABILITIES	VERTICAL PLUG-INS												COMPATIBLE TIME BASES					DBL. SIZE PLUG-INS		
	1400A	1401A	1402A	1403A	1405A	1406A	1407A	1410A	1411A	1430A	1431A	1432A	1420A	1421A	1422A	1423A	1424A	1425A	1415A	1416A
1. Wide Band			•		•			•	•	•	•	•	•	•	•	•	•	•		
2. Sampling								•					•	•				•		
3. High Gain Differential	•			•		•	•						•	•	•	•	•	•		
4. Dual Trace		•	•		•			•	•				•	•	•	•	•	•		
5. X-Y	•	•	•	•	•	•	•	•	•				•	•	•	•	•	•		
6. Delayed Sweep													•	•				•		
7. No Drift						•	•						•	•	•	•	•	•		
8. High Common Mode Rejection				•		•	•						•	•	•	•	•	•		
9. Algebraic Addition		•	•		•			•	•				•	•	•	•	•	•		
10. Time Domain Reflectometry																			•	
11. Wide Band TDF									•	•								•		
12. Swept Frequency																				•

Get the same accuracy, the same linearity, as the hp 140A . . . with higher resolution—the new 8" x 10" CRT hp 143A Oscilloscope. Use it when the readout is to be viewed from a distance or by several people at a time. Use it **anywhere** you need a big picture.

In a bright, easy-to-see 8 x 10-inch display, the 143A has a 20 kV electrostatic CRT. It accepts all 17 of the 140 Series vertical and horizontal plug-ins. This gives you up to 15 MHz dual channel real-time displays, plus exclusive hp 140 Scope System capabilities.

Now get bigger performance in any direction. The selection chart shows the broad measurement capability available.

Call your nearest hp field engineer and ask him about the new hp 143A. Or, write to Hewlett-Packard, Palo Alto, California 94304. Europe: 54 Route des Acacias, Geneva. Price: 143A Oscilloscope mainframe, \$1400; plug-ins, \$250 to \$1600; samplers, \$1000 to \$3000.

088/11



OSCILLOSCOPE SYSTEMS

Circle 901 on reader service card

New Tight Specs

and Super-versatility from DC to 120 MHz with RCA CA-3028B

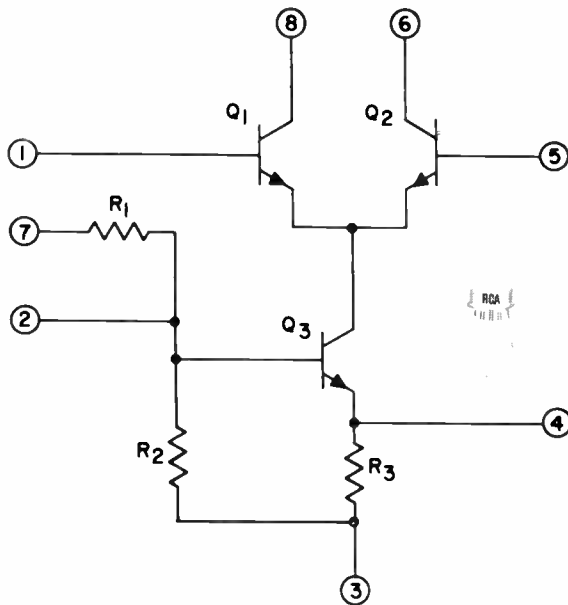

	CA-3028A 89¢ (1,000 units)	CA-3028B \$1.25 (1,000 units)
Voltage gain (typ) diff.	32X	32X
@ 10.7 MHz cascode	98X	98X
AGC range (typ) @ 10.7 MHz	62 dB	62 dB
Input offset voltage (max) @ ± 12V	—	5 mV
Input offset current (max) @ ± 12V	—	6 μA
Input bias current (max) @ ± 12V	106 μA	80 μA
Max. p-p output voltage swing (min) @ ± 12V (R _L = 1.6 kΩ, f = 1 kHz)	—	15V
Voltage gain (min) @ ± 12V (R _L = 1.6 kΩ, f = 1 kHz)	—	40 dB

- Single or dual power supply
- Controlled input-offset voltage and current
- Controlled input bias current
- Unique—use as Differential OR Cascode Ampl
- RF, Converter, and IF in Commercial FM receivers
- Limiter
- Oscillator
- Mixer
- TO-5 package for -55° to + 125° C operation

See your RCA Representative for full details. Ask your RCA Distributor for his price and delivery. And for full technical information and Application Notes on the CA-3028A and the tight spec CA-3028B, write RCA, Electronic Components, Commercial Engineering, Section IC-N-7-1 Harrison, N. J. 07029.

RCA Integrated
Circuits